







# ASSEMBLY INSTRUCTION

DDP-1924

- A**  M6x75mm 8pcs  
**B**  M6x60mm 8pcs  
**C**  3.5x50mm 4pcs  
**D**  3.0x16mm 16pcs  
**R**  1pc  
**L**  2pcs

## PARTS

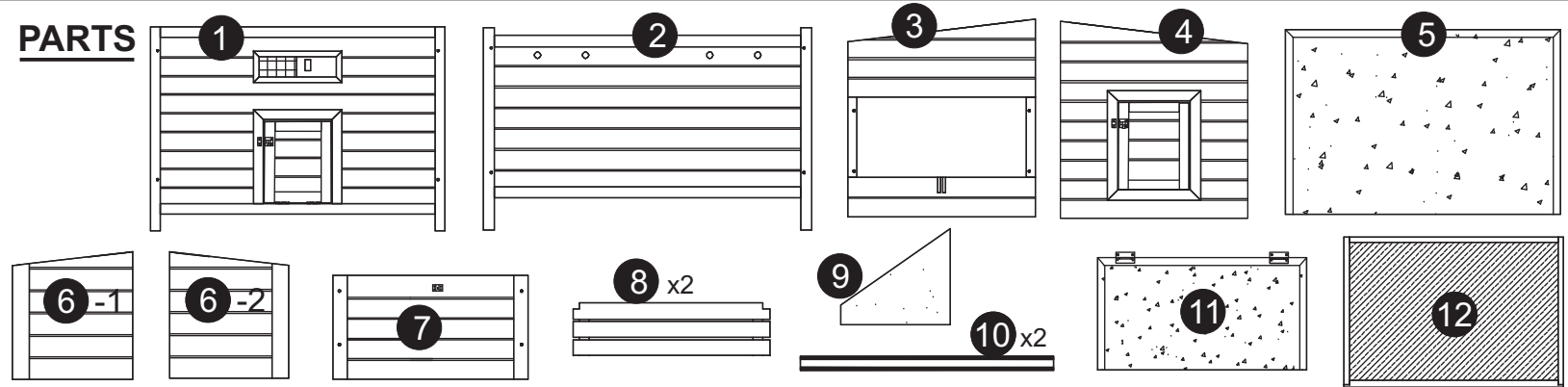

## ASSEMBLY

