

LIBERTY SAFE

QUICK START GUIDE

Congratulations on your purchase of your new high-quality security safe designed and built by America's #1 gun safe company—Liberty Safe! To ensure proper set up and installation, **PLEASE READ THIS QUICK START GUIDE BEFORE OPENING YOUR SAFE.**

Register your safe at www.LibertySafe.com. Online registration must also be completed within (30) days of purchase. Failure to register the product may void any warranty.

Place Serial Number
and Combination Here

INSPECTOR

QUALITY INSPECTION VERIFICATION

I have inspected this safe and found it to meet the high standards set for this product including exterior, lock, locking mechanism and interior.



ALWAYS PROTECTED™

LIBERTYSAFE.COM

SAFETY PRECAUTION

The safe door is heavy. Do not open the door with the safe on an uneven or unstable floor. Hanging on an open door may cause the safe to tip forward when not lag-bolted to the floor, resulting in serious injury or death to yourself or others. **If a bolt down kit was included in your safe, it is strongly recommended that you bolt the safe to the floor to prevent the safe from tipping when the door is opened.** If you have or have occasion to have small children in your home, please make sure you never leave your safe unsecured. It is possible for small children to climb inside your safe and become locked in. This could result in serious injury or death.

PACKAGING MATERIALS

After opening the safe, remove the plastic protectors or foam in the corners of the door.

INSPECT YOUR SAFE

Inspect your safe for shipping damage as soon as you receive it. If you find any damage, please contact the delivery company (or carrier) immediately. Any damage not noted upon delivery must be reported within fifteen (15) days or there will be no recourse. **PLEASE NOTE: Record your safe's serial number and combination and store in a secure location OTHER THAN YOUR SAFE.**

SERIAL NUMBER & MASTER COMBINATION (See opening instructions before proceeding)

PLEASE NOTE: If your safe has been installed with an Electronic Lock, use the Electronic Lock Opening Instructions before proceeding. Your safe's **serial number** is in two (2) locations on the safe. One is located on the top of the safe, back right side. The second is located inside the opening edge of the door. Compare the serial number in this guide with the serial number on the safe. All serial numbers should match. If they do not, contact your local dealer or Liberty Safe immediately. **You will need your safe serial number when contacting customer service about your safe.**

USING THE KEY-LOCK (DAY-LOCK) FEATURE

PLEASE NOTE: The Key-lock will prevent the dial from being turned to open the safe.

However, to obtain the highest level of security it is recommended to lock the safe using the combination and key-lock together rather than the key-lock alone.

Before using the key-lock feature you will need to close the door and rotate the handle until the bolts extend into their locked position.

Step 1. Rotate the dial to the number 0.

Step 2. Insert the key and turn it 180 degrees counterclockwise until it stops (the jagged edge of the key should be facing up).

Step 3. Remove the key and verify the safe is locked by trying to turn the handle.

NOTE: If the safe is NOT locked, try rotating the dial counterclockwise to the number 4 and then back clockwise to 0, then repeat steps 2-3.

CHANGING COMBINATIONS ON MANUAL LOCKS

It is inadvisable for anyone other than a CERTIFIED LOCKSMITH to change the combination on a manual lock. Changing the combination by anyone other than a certified technician will void the lock portion of your warranty. Call your dealer or Customer Service at Liberty Safe @ (800) 247-5625 for help locating an approved locksmith. As part of our continuing service, a record of your combination by serial number is kept on file at Liberty Safe. If you lose your combination it can be restored to you for a \$25.00 research fee provided Liberty has been informed of any combination changes made and you have also met the documentation requirements.

TO GET STARTED, find the lock type below that resembles the one installed on your safe. Then proceed to the instruction set marked in yellow.

LOCK TYPE/MODEL

INSTRUCTION SET

Model 6700
Dial Combination with & without Keylock

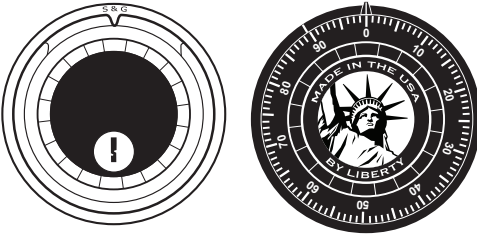

Model Safelogic
TopLit & BackLit Electronic

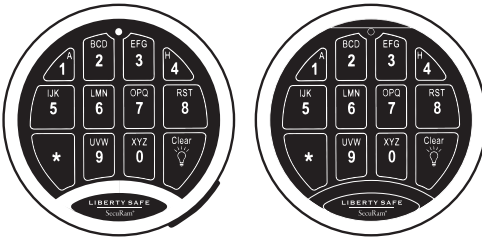

Model Prologic
L01 Electronic

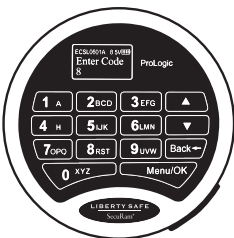

A



6700 DIAL COMBINATION

***Skip to Step 6, if the dial on your safe does not have a keylock in the center.**



1.a

Step 1. Insert key, jagged edge down, into combination dial like shown in figure 1.a. Then turn the key clockwise 180 degrees so the jagged edge of the key is up.

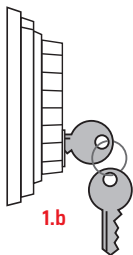

1.b

Step 2. Turn the combination dial clockwise about 45 degrees as shown in figure 1.b until the dial stops turning. It will stop on or between the numbers '87' and '84'. (If the dial did not stop, advance to step 6.) Remove the key.



1.c

Step 3. As shown in figure 1.c, rotate the handle hub clockwise (counterclockwise if the handle is set left of door center) until the door comes open.

Step 4. Swing open door at least 90 degrees as shown in figure 1.d.

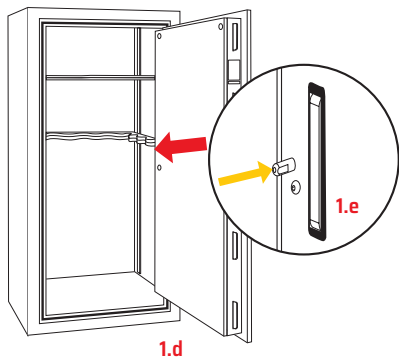

1.d

Step 5. Rotate the handle hub counterclockwise as shown in figure 1.d (clockwise if handle is set left of door center). This will extend the locking bolts/bars so you can test the lock while the door is open (some models require the bolt detent (hinge side of the door, see figure 1.e) be pressed and held in while completing this step.)

Step 6. Locate safe combination on page 2 of this guide and use the instructions in figure 1.f to **verify the combination works.**

Step 7. If the combination dial stops between 84 - 87 you have verified your combination works.

Step 8. *Store combination OUTSIDE of safe!

Step 9. Continue to instruction set D "Remove Safe from Pallet".

Figure 1.f



**4 turns left
to 1st #**

1



**3 turns right
to 2nd #**

2



**2 turns left
to 3rd #**

3



**Turn right until
dial stops
between 84 - 87**

4

B



SAFELOGIC TOPLIT & BACKLIT ELECTRONIC LOCKS

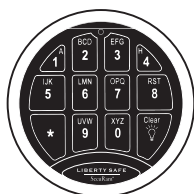

2.a SafeLogic TopLit



2.b SafeLogic BackLit



2.c

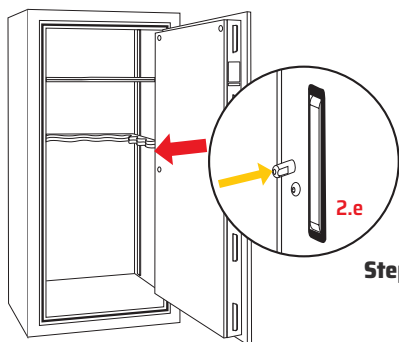

2.d

Step 1. Enter factory set master code 1 2 3 4 5 6

Step 2. As shown in figure 2.c, rotate handle hub clockwise (counterclockwise if handle is set left of door center).

Step 3. Swing open door at least 90 degrees as shown in figure 2.d.

Step 4. Rotate the handle hub counterclockwise as shown in figure 2.c (clockwise if handle is set left of door center). This will extend the locking bolts/bars so you can test the lock with the door open. (Some models require the bolt detent (underside bottom edge of the door, see figure 2.e) be pressed and held in while completing this step.)

Step 5. While the door is open, change the factory set master code to something more secure by completing the following 4 steps:

- a) Enter: 000000
- b) Enter: 1 2 3 4 5 6
- c) Enter: New 6 digit code _____
- d) Enter: New 6 digit code again _____

Step 6. With the door open, verify your new code opens the lock. ***Store combination OUTSIDE of safe!**

Step 7. Continue to instruction set D "Remove Safe from Pallet".



PROLOGIC L01 ELECTRONIC LOCK

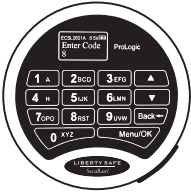

3.a ProLogic L01 Lock

Step 1. Enter factory set master code 1 2 3 4 5 6

Step 2. Then, within 6 seconds, rotate the handle hub clockwise, as in shown in figure 3.b (counterclockwise if handle is set left of door center).



3.b

Step 3. Swing open door at least 90 degrees as shown in figure 3.c.

Step 4. Rotate the handle hub counterclockwise as shown in figure 3.c (clockwise if handle is set left of door center). This will extend the locking bolts/bars so you can test the lock with the door open. (Some models require the bolt detent (underside bottom edge of the door, see figure 3.d) be pressed and held in while completing this step.)

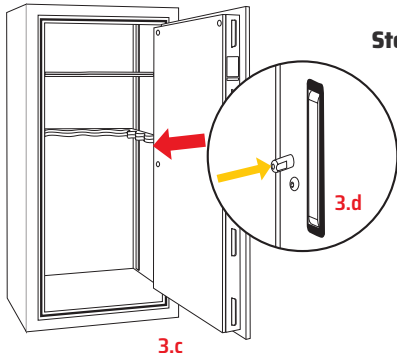

3.c

Step 5. With the door open, change the factory set code to something more secure by completing the following these steps:

- a) Press the Menu/OK button
- b) Press “▲” or “▼” and choose System Menu
- c) Press the Menu/OK button
- d) Enter: 1 2 3 4 5 6
- e) Press “▲” or “▼” and choose Change Code
- f) Press the Menu/OK button
- g) Enter: New 6 digit code _____
- h) Enter: New 6 digit code again _____

Step 6. With the door open, verify your new code opens the lock. ***Store combination OUTSIDE of safe!**

Step 7. Continue to instruction set D “Remove Safe from Pallet”.

D REMOVING SAFE FROM PALLET

ⓘ **PLEASE NOTE:** Take precaution when completing these next steps. The safe is extremely heavy! It is recommended that two or more adults work together when removing the safe from the pallet.

Step 1. Remove side shelves and accessories from interior floor.

Step 2. Locate the lag screws that secure the safe to the pallet. Lag screws are located in ONE of the following two areas (see next page for diagrams):

- a. If the safe interior has plastic caps pressed into each corner of the carpeted floor (see figure 4.a) remove these caps to access the lag screws.

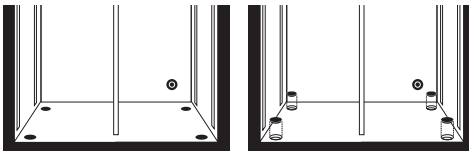

Figure 4.a Lag Screw Cover

- b. If your safe interior has straps attached to the front center of the floor (see figure 4.b), pull the straps up and lift out the floor boards. This will allow access to the lag screws.

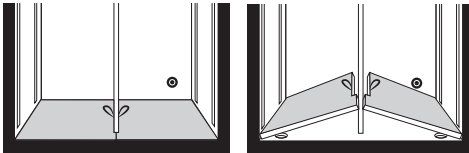

Figure 4.b Floor Board Removal

ⓘ **PLEASE NOTE:** While performing step 3, another adult must steady the safe to prevent the safe from tipping off the pallet while removing the lag screws.

Step 3. Use a 9/16 inch socket wrench to unscrew each of the four lag screws.

Step 4. After removing all lag screws, close the door and turn the handle to prevent the door from swinging open during step 5.

Step 5. With one person on each side of the safe as shown in figure 4.c, carefully slide the safe off the pallet until one edge is resting on the floor. While the safe is tilted on its edge, remove the pallet from under the safe. Carefully lower the safe back to its upright position.

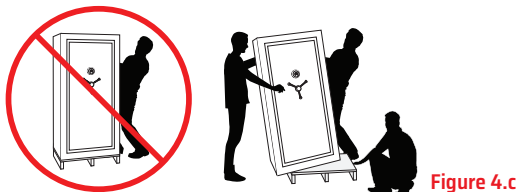

Figure 4.c

Step 6. Continue to the next instruction set “Interior and Handle Setup”.

E

INTERIOR AND HANDLE SETUP

ⓘ **PLEASE NOTE:** Prior to beginning this section, you should have already tested the lock. If you experienced problems refer the troubleshooting guide in the back of the Use and Care Manual.

Step 1. Locate the padded yellow envelope inside the safe on the floor. This package contains the shelf clips and handle spokes. Remove the handle spokes and screw each one into the hub as shown in figure 5.a. (If your safe has a solid single-point handle you can skip this step. Handle may have up to 5 spokes.)

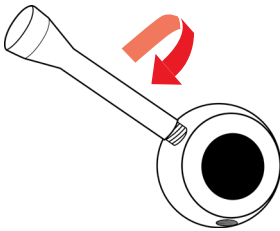

Figure 5.a Install handle spokes

Step 2. Remove the shelf clips from envelope. Insert the top of each clip as shown in figure 5.b at the desired shelf level. Firmly press down on the top (flat side) of the clip until the bottom of the clip snaps onto the track. Install 4 clips per shelf, making sure each one is at the same level.



Figure 5.b Install shelf clips

Step 3. Side shelves can be adjusted to meet your needed configuration. Locate the shelves inside of the safe. Place each shelf on top of the previously installed shelf clips. The style and quantity of the shelves will vary by model. See figure 5.c for examples of how your interior may look after setup.

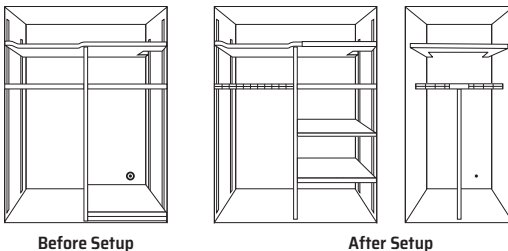
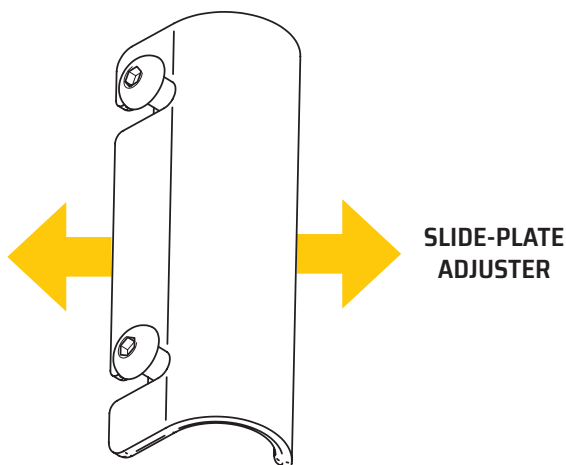

Figure 5.c Interior setup

F DOOR ADJUSTMENT

Step 1. Most safe models have two door adjusters for tightening or loosening the door. These adjusters are located just inside the safe on the left doorjamb. After removing all packaging material, close the door and extend the bolts. Pull out on the door handle to check the tightness. If there is play in the door, you will need to adjust the slide plate. Using the supplied hex wrench, loosen the two (2) hex adjuster screws. Slide the adjuster left to loosen and right to tighten the door. Retighten screws and check adjustment. When properly adjusted, you should feel slight resistance when turning the handle to extend the door bolts. Only slight movement should be felt with the door shut.

⚠ CAUTION: Do not adjust door too tight. This may cause wear on both the door pins and locking mechanism. If your door has a tendency to self-open (the bolts retract by themselves) or the handle is hard to turn when extending the bolts, the door adjusters may be too tight.



G

INSTALLING CONCRETE ANCHORS

Ⓢ **PLEASE NOTE:** Concrete anchor kits are sold separately and can be purchased only at libertysafe.com or through your local Liberty Safe dealer.



PN 10915

TOOLS REQUIRED:

- Hammer Drill
- ½" Socket Set
- Shop Vacuum
- Hammer

Ⓢ **IMPORTANT!** To achieve the highest level of security and safety possible, anchor your safe securely to the floor. We recommend placing a protective barrier (such as a piece of carpet, treated wood or rubber mat) between the safe and floor to prevent scratching of the safe surface, which could lead to rust. Before anchoring safe, make sure the safe is level. Use appropriate hardware for the wood or cement surface you are anchoring to. Securing it to the floor helps secure and prevent removal of the safe by thieves.

Ⓢ **PLEASE NOTE:** If a bolt down kit was included in your safe, it is strongly recommended that you bolt the safe to the floor to prevent the safe from tipping when the door is opened.

Step 1. Remove safe from pallet (refer to section D for instructions) and place safe in desired location.

- a. **NOTE:** leave floorboards/caps removed, as you will be using these four anchor points

Step 2. Drill a hole in each of the four anchor points with a hammer drill using a ⅜" concrete drill bit. Drill the holes approximately 3" deep.

Step 3. Use vacuum to clean up debris creating by drilling the holes.

Step 4. Hammer the anchor bolts into the holes and tighten using a ½" inch socket set.

Step 5. Replace floor caps/floor panels.

H INSTALLING WOOD ANCHORS

ⓘ **PLEASE NOTE:** Wood anchor kits are sold separately and can be purchased only at libertysafe.com or through your local Liberty Safe dealer.



PN 10914

TOOLS REQUIRED:

- Drill
- 9/16" Socket Set
- Shop Vacuum

ⓘ **IMPORTANT!** To achieve the highest level of security and safety possible, anchor your safe securely to the floor. We recommend placing a protective barrier (such as a piece of carpet, treated wood or rubber mat) between the safe and floor to prevent scratching of the safe surface, which could lead to rust. Before anchoring safe, make sure the safe is level. Use appropriate hardware for the wood or cement surface you are anchoring to. Securing it to the floor helps secure and prevent removal of the safe by thieves.

ⓘ **PLEASE NOTE:** If a bolt down kit was included in your safe, it is strongly recommended that you bolt the safe to the floor to prevent the safe from tipping when the door is opened.

Step 1. Remove safe from pallet (refer to section D for instructions) and place safe in desired location.

a. **NOTE:** leave floorboards/caps removed, as you will be using these four anchor points

Step 2. Drill a hole in each of the four anchor points with a drill using a ¼" wood drill bit. Drill holes approximately 3" deep.

Step 3. Use vacuum to clean up debris creating by drilling the holes.

Step 4. Place provided washers on provided wood bolts and secure them using a 9/16" socket set or drill.

Step 5. Replace floor caps/floor panels.



CLEANING AND MAINTAINING YOUR SAFE

MANUAL LOCKS

It is recommended that you have your manual lock serviced annually by a certified lock technician to maintain trouble-free service. Electronic locks do not require this service.

LOCKING PINS/BARS – Once per year extend the bolts and wipe a small amount of lubricating oil or Vaseline along the bottom of the middle most (2nd, 3rd, or 4th bolt down) bolt on the hinge and open side of the door.

INTERNAL LOCKING MECHANISM – The advanced locking mechanism requires no maintenance. Opening the door panel of your safe by anyone other than a certified lock or safe technician may void your warranty.

EXTERIOR – Use a soft, non-abrasive cloth dampened with water to clean the surface of a gloss, powder coat or textured finish safe. Other materials may cloud or scratch the finish of your safe:

- Logos and other graphic images must be wiped gently. Never rub or polish
- The lock and handle have a protective coating to prevent tarnish. **DO NOT** use metal polishes or solvents for cleaning. Simply wipe off with a soft cloth.
- Scratches and other blemishes may be touched up with a paint touch up kit available from your dealer.

FIRE SEAL – The fire seal does not need maintenance unless it is ripped or destroyed.

⚠SAFETY PRECAUTIONS: Before moving you safe, make sure you have completely tested the combination and lock to assure it will open properly prior to removing the safe from the pallet and to its final location. Safe doors are NOT designed to be removed due to possible serious injury. Never move the safe with the door open. Do not open the door with safe lying down. The safe's door should never be removed. Removing the safe door will void the warranty on your safe. Safes are very heavy and awkward to handle. Only use of proper moving equipment by a trained professional is recommended. Using a standard refrigerator dolly is very dangerous and can cause injury or death.



LIBERTY SAFE WARRANTY

LIBERTY SAFE AND SECURITY PRODUCTS, INC. LIMITED WARRANTY

Limited Lifetime Warranty: Liberty Safe and Security Products, Inc. (Liberty) is proud of the workmanship of the product you have just purchased. Liberty warrants that each new safe will be free from defects in material and workmanship for the lifetime of the original purchaser (Purchaser). If there is a defect in either materials or workmanship of a warranted safe during the lifetime of the original purchaser, Liberty will repair or replace the safe. Liberty will also repair or replace any warranted safe that is damaged during a fire (other than by arson committed by Purchaser, a member of Purchaser's family, or someone instructed or authorized by Purchaser or a member of Purchaser's family), illegal and/or unauthorized break-in, or an illegal and/or unauthorized attempted break-in, if a homeowner's insurance policy will not cover the damage, during the lifetime of the original purchaser. **Liberty's obligation under the limited lifetime warranty is limited to repair or replacement of the safe or product itself, AND DOES NOT EXTEND TO THE CONTENTS OF THE SAFE.** This limited lifetime warranty does not include the lock and painted surface, or electrical items (see separate limited warranties below), and is subject to the following terms, conditions, and limitations:

Cost to Purchaser:

Inside United States: Liberty's limited lifetime warranty is at no cost to the Purchaser, including labor and shipping.

Inside Canada: Liberty's limited lifetime warranty is at no cost to the Purchaser, except that Purchaser is responsible for all freight charges if a safe is replaced.

Outside of the United States & Canada: Liberty will provide replacement parts of like type and function for the safe at no cost to the purchaser. However, any and all labor, repair, or service costs will be the responsibility of Purchaser, and Purchaser is responsible for all freight charges if a safe is replaced.

Lock and Painted Surface Limited Warranty: Locks and painted surfaces are warranted to be free from defects in workmanship and materials for a period of five (5) years from the date of purchase. Within this five year period Liberty will repair and/or replace parts of like kind and type at no cost to the Purchaser, except that outside the United States and Canada, Liberty will provide replacement parts of like kind and type at no cost to purchaser, but Purchaser will be responsible for any and all labor, repair, or service costs.

Electrical Items Limited Warranty: Light fixtures, transformers, cords, and light switches are warranted to be free from defects in workmanship and materials for a period of one (1) year from the date of purchase. Within this one-year period Liberty will replace parts of like kind and type at no cost to the Purchaser. Purchaser will be responsible for any and all labor, repair, or service costs.

Proper Use for Intended Purpose: Liberty takes seriously its obligation to stand behind its product with this Limited Warranty as long as the safe is properly installed and cared for as instructed in the Owner's Use and Care Manual. This Limited Warranty does not apply to safes or parts that have been misused, neglected or subjected to unusual or extreme conditions and/or environments, or to unreasonable wear and tear. Changing or modifying the safe in ways that affect its intended use will void this Limited Warranty. **FOR OPTIMAL SECURITY AND PROTECTION, SAFES SHOULD BE BOLTED TO THE FLOOR. PLEASE REFER TO THE USE & CARE MANUAL FOR DETAILS ON ANCHORING YOUR SAFE TO THE FLOOR.**

Warranty Registration: For this Limited Warranty to be valid, online registration MUST be completed within (30) days of purchase. Failure to register the product shall void any warranty.

Warranty Claims: Claims shall be made under this Limited Warranty by calling 800-247-5625 or writing to Liberty Safe and Security Products, 1199 West Utah Avenue, Payson, Utah 84651. Any claims made for fire, break-in or break-in attempts must be accompanied by a copy of your homeowner's insurance statement of coverage, and a report made by the police or fire department. A claim must be made within six months of the fire, break-in, or attempted break-in.

Venue and Choice of Law: Any claims arising from this limited warranty shall be resolved in the State of Utah and Utah law will apply to any dispute.

No Other Warranties: This Limited Warranty is understood to be the complete and exclusive agreement between the parties, superseding all prior warranties or agreements, oral or written, and all other communications between the parties relating to the subject matter of this Limited Warranty. No employee of Liberty or any other party is authorized to make any warranty in addition to those made herein.

Limitation of Remedies: In no case shall Liberty be liable for any punitive, special, indirect, incidental, or consequential damages based upon breach of warranty, breach of contract, negligence, strict tort, or any other legal theory relating to the subject matter of this Limited Warranty. Such damages include, but are not limited to, loss of profits, loss of savings or revenue, loss of the contents of the safe or vault door, loss of use of the safe or vault door, or any associated equipment, cost of capital, cost of any substitute equipment, facilities or services, downtime, the claims of third parties including customers, and injury to property. Liberty's maximum liability for any damages based upon breach of warranty, contract, tort, statute, or otherwise relating to the subject matter of this Limited Warranty, shall be limited to the cost of the safe paid by the Purchaser.

TO THE FULL EXTENT PERMITTED BY LAW, THIS LIMITED WARRANTY IS EXCLUSIVE AND THERE ARE NO OTHER EXPRESS OR IMPLIED WARRANTIES, INCLUDING WARRANTIES OF MERCHANTABILITY OR FITNESS FOR A PARTICULAR PURPOSE. ANY WARRANTIES IMPLIED BY LAW SHALL IN NO EVENT EXTEND BEYOND DURATION OF THIS LIMITED WARRANTY. IN NO EVENT SHALL THIS LIMITED WARRANTY BE DEEMED TO COVER ANY PUNITIVE, SPECIAL, INDIRECT, INCIDENTAL OR CONSEQUENTIAL DAMAGES OF ANY KIND ARISING OUT OF THE PURCHASE OR USE OF THIS PRODUCT, WHETHER BASED UPON THIS WARRANTY, CONTRACT, TORT, STATUTE OR OTHERWISE. THIS LIMITED WARRANTY GIVES YOU SPECIFIC LEGAL RIGHTS, AND YOU MAY ALSO HAVE OTHER RIGHTS WHICH VARY FROM STATE TO STATE. SOME STATES DO NOT ALLOW LIMITATIONS ON HOW LONG AN IMPLIED WARRANTY LASTS, SO THE ABOVE LIMITATION MAY NOT APPLY TO YOU.

Your safe is now ready to protect your valuables. For additional instructions a full Use & Care Manual can be downloaded from our website www.libertysafe.com/ownersmanual.php. If you experienced a problem, you can consult the troubleshooting guide within the Use & Care Manual online. For additional online help visit www.libertysafe.com/services.php or contact customer service by phone (800) 247-5625. Support is available Mon-Fri, 8:00am to 5:00pm Mountain Standard Time. You will need your safe serial number when contacting customer service about your safe.

LOST COMBINATION OR KEYS

The lock on your safe has been set with a randomly selected combination at the time of manufacturing. As part of our continuing service, a record of your combination by serial number is kept on file. To help us better serve you, please contact Customer Support at (800) 247-5625 when you change your combination or code. If you lose your combination, you can retrieve a copy for a \$25.00 research fee, provided you have not changed it from the original combination. You must complete certain security and documentation requirements. If you lose your keys you can obtain duplicate for \$5.00 each key, plus \$5.00 shipping and handling. Go to www.libertysafe.com to download a combination/duplicate key request form.



ALWAYS PROTECTED™

LIBERTYSAFE.COM