



# yel-Low Safety Dolly/ Shuttle Dolly

## INSTRUCTION MANUAL



For Technical Support, Call

770-974-0021

888-SAWTRAX (888-729-8729)

Watch a video of  
configuring and moving a load at:

<https://vimeo.com/249200637>

# PARTS OF THE yel-Low SAFETY DOLLY

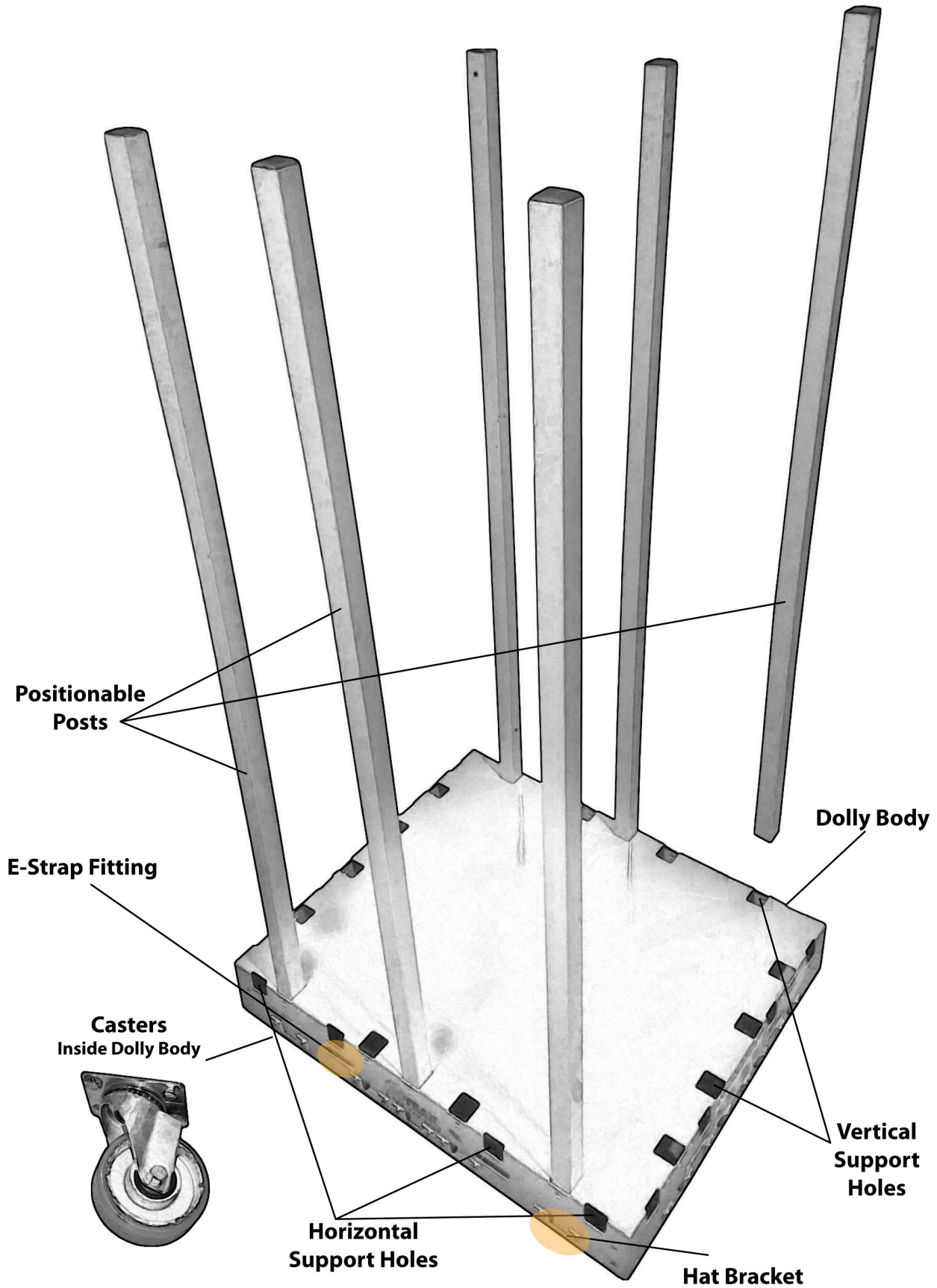

## ABOUT THE DOLLY

The yel-Low Safety Dolly allows you to effortlessly load and move items.

Can move most any item up to 1000 lbs.

It is intended to transport goods. Any use other than intended use can result in injury or product damage. If dolly is damaged, defective, or missing parts, it should be taken out of use until repaired or replaced.

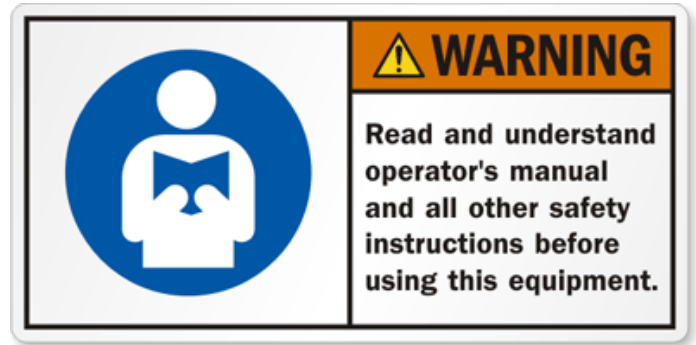

## UNPACKING THE DOLLY

When unpacking, CHECK TO MAKE SURE THAT THE DOLLY IS INTACT / UNDAMAGED and that all ordered parts are included. If any parts are missing or broken, please call Saw Trax Manufacturing as soon as possible at 770-974-0021.

## IMPORTANT WARNINGS AND SAFETY PRECAUTIONS



1. Read and understand directions. Failing to follow instructions may result in serious injury or property damage.
2. Use this tool for manufacturer's recommended use only. Use other than which is described may result in injury or property damage.
3. Do not exceed 1000 lb. max. weight capacity (base model).
4. CAREFULLY AND SMOOTHLY start, stop and change direction.
5. Be aware that loads in motion have more force/weight than stationary loads. Sudden or rapid load movement may briefly create excess load force and result in product failure and/or a tipping hazard.
6. EVENLY CENTER YOUR LOAD. This equipment is designed for evenly centered loads. Off-centering of loads can result in a dangerous operating condition and cause damage or injury.
7. When possible, KEEP LOAD STRAPPED to dolly during transport (E-Strap).
8. Use extreme caution when handling loosely stacked/package loads.
9. Do not use when tired or under the influence of drugs or medication.
10. Always look in direction of travel.
11. Use caution when visibility is obstructed by load.
12. Ensure floor is clear of debris when moving a load.
13. When maneuvering a load, watch swing clearance near walls, racks, pillars and other obstacles.
14. Do not use on uneven or slippery surfaces.
15. Be aware that the casters behave differently without a load than with a load.
16. DO NOT RIDE ON THIS EQUIPMENT. Do not carry passengers.
17. Maintain product labels and nameplates. These carry important safety information. If unreadable or missing, contact Saw Trax Manufacturing for a replacement.

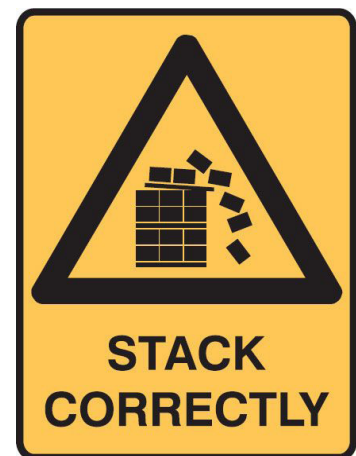



## SUGGESTIONS FOR SAFEST AND EASIEST USE

### Plan and prepare for the job before attempting to load the dolly

- Be sure the Dolly can handle your load's weight and size (base model: 1000 lbs. max); do not overload dolly
- Inspect dolly before each use for broken or bent areas and loose nuts/bolts
- If applicable, test brake operation before each use (pg.8)
- Dress Safely
  - \* Wear sturdy shoes with nonskid soles to protect your feet from dropped loads and dolly wheels; ANSI-approved steel-toed shoes are recommended
  - \* Wear gloves that will provide a good grip
  - \* Avoid loose or baggy clothing that could catch in the dolly or cause tripping
- Ensure Load Balance And Stability
  - \* Place heavy objects at the bottom
  - \* Evenly center your load
  - \* Secure objects on dolly during transport to prevent shifting or falling

### Operate Dolly Carefully to Minimize Physical Strain and Maximize Control

- Bend your knees and keep your back straight when loading or unloading
- Walk, do not run when transporting a load
- Never brace or brake the dolly with your foot
- When traveling downhill, stay behind the dolly
- When traveling uphill, stay in front of the dolly
- "Keep Your Eyes on the Road" and Stay Alert
  - \* Be on the lookout for other vehicles
  - \* Keep yourself and the dolly wheels away from dock and platform edges
  - \* Inspect the floor for obstacles, slippery spots, inclines, blind corners, or debris that could block casters

## OPERATING THE yel-Low SAFETY DOLLY

1. The yel-Low Safety Dolly is extremely easy to use. Place posts into the support holes around the dolly into a configuration that works for you. It is completely customizable. (Optional post lengths available)

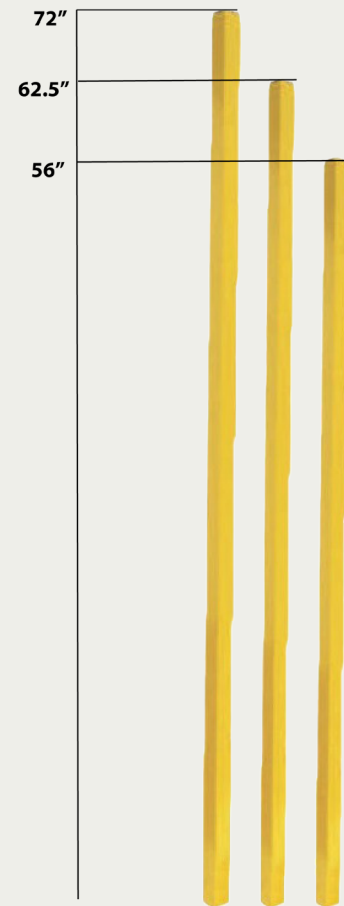
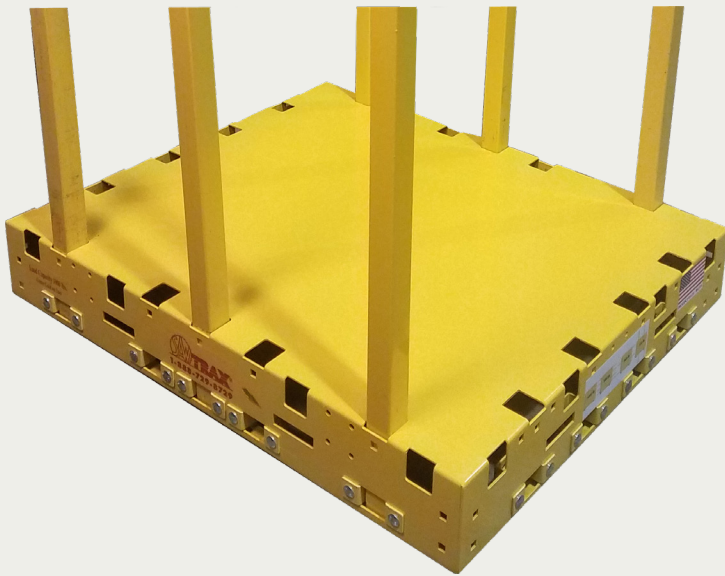

2. Positionable posts can also be placed horizontally to give you more base area for longer/wider loads.

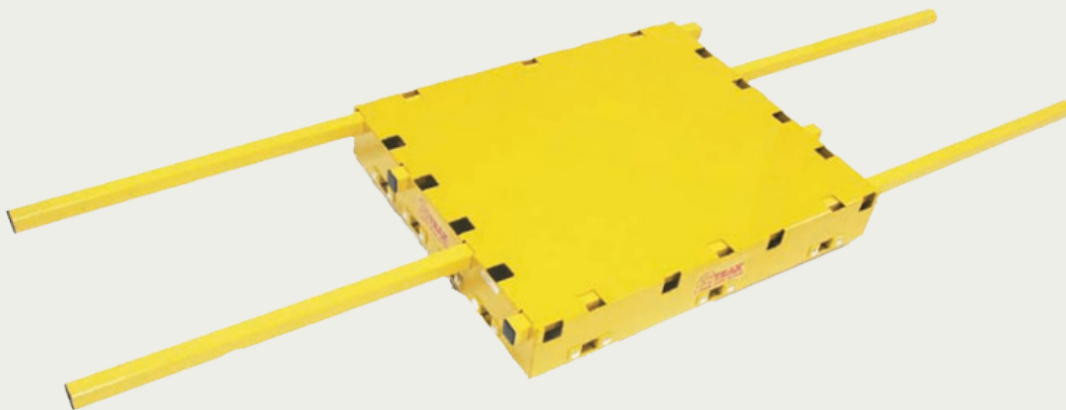

## OPERATING THE yel-Low SAFETY DOLLY (Continued)

- Simply load up your product and you are ready to go.



## HELPFUL FEATURES

### OMNI DIRECTIONAL CASTERS

4-inch omni-directional casters (base model) allow the load to be moved in any direction. This allows for exceptional maneuverability even in the tightest of spaces, around corners and through cluttered walkways. (5" caster option)

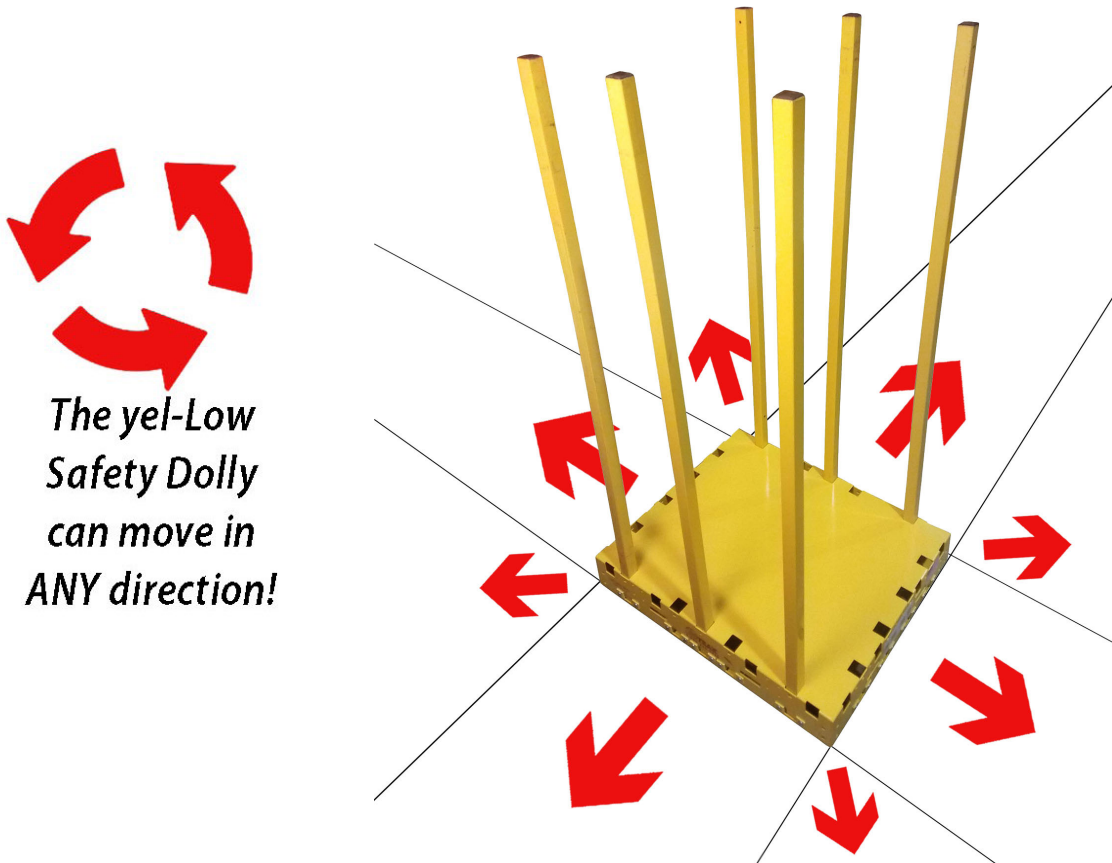

## HELPFUL FEATURES (Continued)

These omni-directional casters are protected inside the dolly body on the base model.

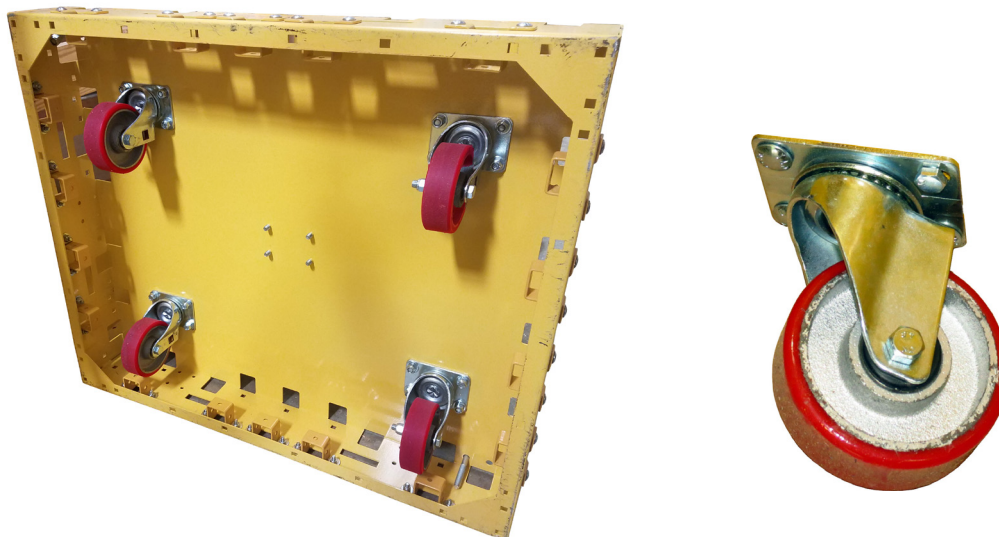

### NO TIPPING OVER

The dolly will not fall over if misloaded because of the casters hidden inside the dolly body. Instead of falling over, it just tilts and rests on the bottom sides. This makes it much safer than any flat cart or hand truck.

*\*Although this safety is in place, only center loading is recommended\**

## OPTIONAL UPGRADES

Call us or visit <https://www.sawtrax.com/product/yel-low-safety-dolly/> for more information

### RAISED CASTERS

Locking casters are mounted on the outside corners instead of inside the body. This configuration allows for navigating rough terrain. When using the raised casters, an additional bracket is used inside the dolly body.

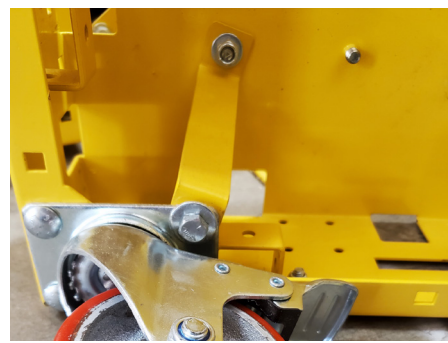

## BRAKES

For stabilization, toggle brake clamps can be mounted to the exterior of low the 4" caster dolly body. Sold in pairs.



---

## CORNER PROTECTORS/CONNECTORS

Prevents the corners from gouging a wall, especially handy in hotels and office buildings. Also can be used when connecting two or more dollies.



---

## DOCK TRANSITION WHEELS

Used for taking the low 4" caster dolly in and out of trucks over dock plates. Includes 1 extra caster for center of dolly.





## OPTIONAL UPGRADES (Continued)

### POST LENGTHS

Standard posts are 56" long.  
62.5" posts are available for use with  
Mattresses and 72" posts for  
Doors and/or Windows.

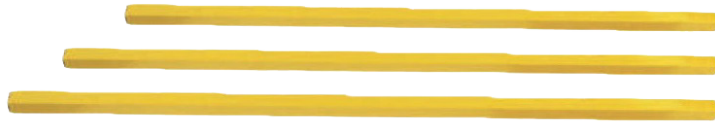

### FORKLIFT POSTS

Stores vertically.  
Exclusively for the yel-Low Safety Dolly.  
*\*Not applicable to Shuttle Dolly\**



### FORKLIFT CHANNELS

Lift your dollies into trucks and onto shelves.  
Exclusively for the Raised yel-Low Safety Dolly. (1 Channel per cart. Minimum order of 2)  
Available in 25" and 30" Channels. *\*Not applicable to Shuttle Dolly\**



Call us or visit <https://www.sawtrax.com/product/yel-low-safety-dolly/> for more information

## THE SHUTTLE DOLLY

This larger version of the yellow Safety Dolly has a wider base and increased carrying capabilities. Having a base of 29 in. x 36 in.

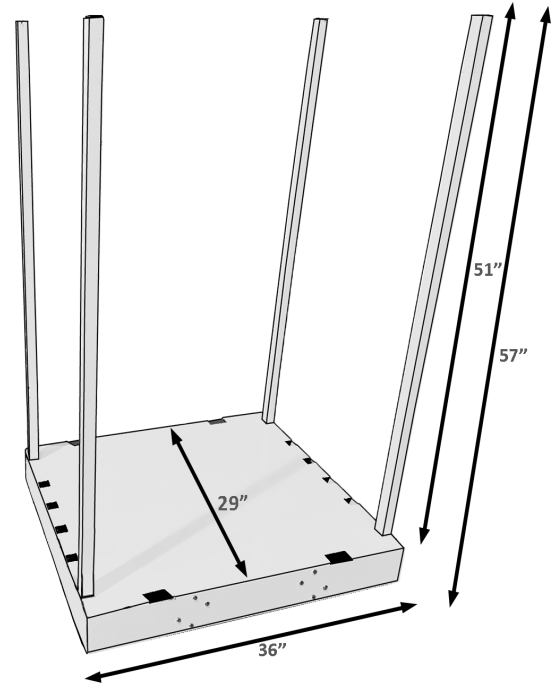

Base Shuttle >

## THE FULFILLMENT SHUTTLE

With the wheelbarrow handles, loads can be transported without touching the product. Instead of turning a loaded dolly around in a confined space, the wheelbarrow handles can be removed and inserted from the other end.

## THE MATTRESS SHUTTLE

Made for mattress and TV transport. With the 5 inch omni directional casters and tall 62.5 inch posts, this dolly has greater clearance with less potential to drag product on the ground.



Mattress Shuttle >



< Fulfillment Shuttle

## INSTALLING OPTIONAL ADDITIONS (Raised Casters)



x 4

### Required Materials

4	Red Swivel Locking Caster
4	Yellow Caster Support Bracket
16	5/16in. Carriage Bolt
8	5/16in. Flat Washer
12	5/16in. Lock Washer
8	5/16in. Lock Nut
12	5/16in. Hex Nut

### Required Tools

Ratchet with Deepwell ½ in. drive socket.

### Assembly Procedures:

1. Place one (1) Red Swivel Locking Caster onto bottom corner of cart body. (Figures 1 and 2)
2. Place three (3) 5/16in. Carriage Bolts through Red Swivel Locking Caster and Cart Body.
3. Place three (3) 5/16in. Lock Washers onto Carriage Bolts.
4. Place three (3) 5/16in. Hex Nut onto Carriage Bolts. Tighten all hardware.
5. Place one (1) Yellow Caster Support Bracket onto threaded cart body stud. (Figure 3)
6. Insert one (1) 5/16in. Flat Washer onto threaded cart body stud.
7. Insert one (1) 5/16in. Lock Nut onto threaded cart body stud. Spin Yellow Caster Support Bracket under Red Swivel Locking Caster.
8. Insert one (1) 5/16in. Carriage Bolt into caster hole and Yellow Caster Support Bracket.
9. Insert one (1) 5/16in. Flat Washer onto 5/16 in. Carriage Bolt and Yellow Caster Support Bracket.
10. Insert one (1) 5/16in. Lock Nut onto 5/16 in. Carriage Bolt and Yellow Caster Support Bracket
11. Repeat steps 1 thru 10 for the remaining Red Swivel Locking Casters.

Figure 1



Figure 2



Figure 3



## INSTALLING OPTIONAL ADDITIONS (Dock Transition Wheels)

**Dock Transition Wheels:** Used to transition the dolly on uneven surfaces like dock transitions to load trucks. Comes with 2 wheels per opposite ends of the dolly. A 5th red swivel caster will be added to the center of the dolly body.



x 4



x 1

### Required Materials

- 1 Red Locking Swivel Caster
- 4 Dock Transition Wheel with Bracket
- 8 5/16 in. Carriage Bolt
- 5 5/16 in. Lock Nut
- 7 5/16 in. Hex Nut
- 9 5/16 in. Flat Washer
- 11 5/16 in. Lock Washer

### Required Tools

Ratchet with Deepwell 1/2 in. Socket

### Assembly Procedures:

1. Insert one (1) 5/16 in. Carriage Bolt into bolt hole from inside out through wheel bracket and cart body.  
(Bolt should drop into provided square cut hole in bracket to allow low profile appearance.) (Figure 2)
2. Place one (1) 5/16 in. Flat Washer on each protruding bolt stud. (Figure 1)
3. Place one (1) 5/16 in. Lock Washer on each protruding bolt stud. (Figure 1)
4. Install one (1) 5/16 in. Lock Nut and one (1) 5/16 in. Hex Nut per Dock Transition Wheel protruding bolt stud. (Figure 1)
5. Place Fifth Red Swivel Caster onto center threaded cart body studs. (Figure 3)
6. Install one (1) 5/16 in. Flat Washer and three (3) 5/16 Lock Washers on center cart body threaded studs.
7. Install one (1) 5/16 in. Lock Nut onto Flat Washer and three (3) 5/16 Hex Nuts onto Lock Washers on center cart body threaded studs.

Figure 1



Figure 2



Figure 3



## INSTALLING OPTIONAL ADDITIONS (Brake Kit)

**Brakes:** Come in a pair. Great for stabilizing the dolly. The toggle clamp slightly raises the dolly taking the weight off the wheels (Figures 1 & 2). They can be used in the back or on the sides.



### Required Materials

- 2 Cart Brakes
- 8 ¼ in. Hex Bolt
- 2 ¼ in. Lock Nut
- 6 ¼ in. Hex Nut
- 8 ¼ in. Flat Washer

### Required Tools

Ratchet with Deepwell 7/16 in. drive socket.

### Assembly Procedures:

1. Insert one (1) ¼ in. Hex Bolt into each bolt hole from outside in. (Figure 3)
2. Place one (1) ¼ in. Flat Washer on each bolt stud.
3. Install one (1) ¼ in. Lock Nut and three (3) ¼ in. Hex Nuts per Brake Assembly and tighten with socket.

Figure 1

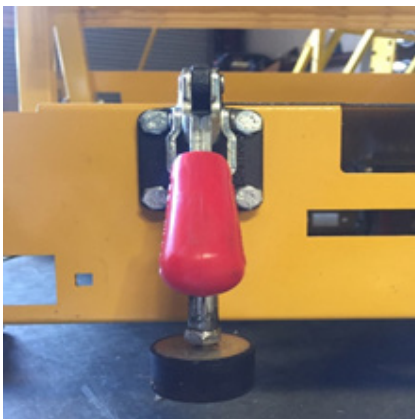

Figure 2



Figure 3



Revised 08/05/2020.

For information on the compatibility of the yel-Low Safety Dolly with any products introduced after this date, contact Saw Trax.

## Warranty and Service

Saw Trax Mfg., Inc. warrants every product it sells against manufacturers' defects and each product is designed to give years of dependable service. Your new Cart or Dolly was built from the finest components available by our trained craftsmen.

### Warranty Period:

The general warranty lasts for the time specified in the literature included with your product or on the official Saw Trax Mfg., Inc. branded website.

- Saw Trax Mfg., Inc. products carry a limited warranty which varies in duration based upon the product. (See *Product Listing with Warranty Period*)
- Accessories carry a limited warranty of 90 days from the date of receipt.
- Consumable items are defined as expendable parts or accessories expected to become inoperable within a reasonable amount of use and are covered by a 90-day limited warranty against manufacturer's defects.

### Who is Covered:

This warranty covers only the initial purchaser of the product from the date of delivery.

### What is Covered:

This warranty covers any defects in workmanship or materials subject to the limitations stated below. This warranty does not cover failures due directly or indirectly to misuse, abuse, accidents, normal wear-and-tear, improper repair, alterations or lack of maintenance. Use of these machines in the processing of metal or some other materials may void the warranty. This warranty gives you specific legal rights, and you may also have other rights which may vary from state to state.

Saw Trax Mfg., Inc. will repair or replace, at our discretion, any component that is determined to be defective. Repair or replacement is limited to providing replacement parts from the factory. Saw Trax Mfg., Inc. assumes no responsibility for making repairs on site. Parts returned to the factory must be returned freight prepaid and include a Return Authorization (R.A.) number. Please call 770-974-0021 for a R.A. number.

### Product Listing with Warranty Period:

- 90 Days- Parts, Consumable items
- 90 Days- Accessories
- 3 Year- Cart or Dolly Body

Note: Custom designed Carts/Dollies are exempt from warranty

### How to Get Technical Support:

Please contact Technical Service by calling 888-SAW-TRAX. Please note that you will be asked to provide proof of initial purchase when calling. If a product requires further inspection, the Technical Service representative will explain and assist with any additional action needed.

### More Information:

Saw Trax Mfg., Inc. is constantly adding new products. For complete, up-to-date product information, check with your local distributor or visit the Saw Trax Mfg., Inc. website.

Saw Trax Mfg., Inc. sells through distributors. The specifications listed in Saw Trax Mfg., Inc. printed materials and on the official Saw Trax Mfg., Inc. website are given as general information and are not binding. Saw Trax Mfg., Inc. reserves the right to effect at any time, without prior notice, those alterations to parts, fittings, and accessory equipment which they may deem necessary for any reason whatsoever.

### Limitations on This Warranty:

SAW TRAX MFG., INC. SHALL IN NO EVENT BE LIABLE FOR DEATH, INJURIES TO PERSONS OR PROPERTY, OR FOR INCIDENTAL, CONTINGENT, SPECIAL, OR CONSEQUENTIAL DAMAGES ARISING FROM THE USE OF OUR PRODUCTS. SOME STATES DO NOT ALLOW THE EXCLUSION OR LIMITATION OF INCIDENTAL OR CONSEQUENTIAL DAMAGES, SO THE ABOVE LIMITATION OR EXCLUSION MAY NOT APPLY TO YOU.

