



4-Position Scoop Dolly

INSTRUCTION MANUAL



For Technical Support, Call

770-974-0021

888-SAWTRAX (888-729-8729)

Watch an instructional video of
picking up and moving a load at:

<https://vimeo.com/332051838>

PARTS OF THE SCOOP DOLLY

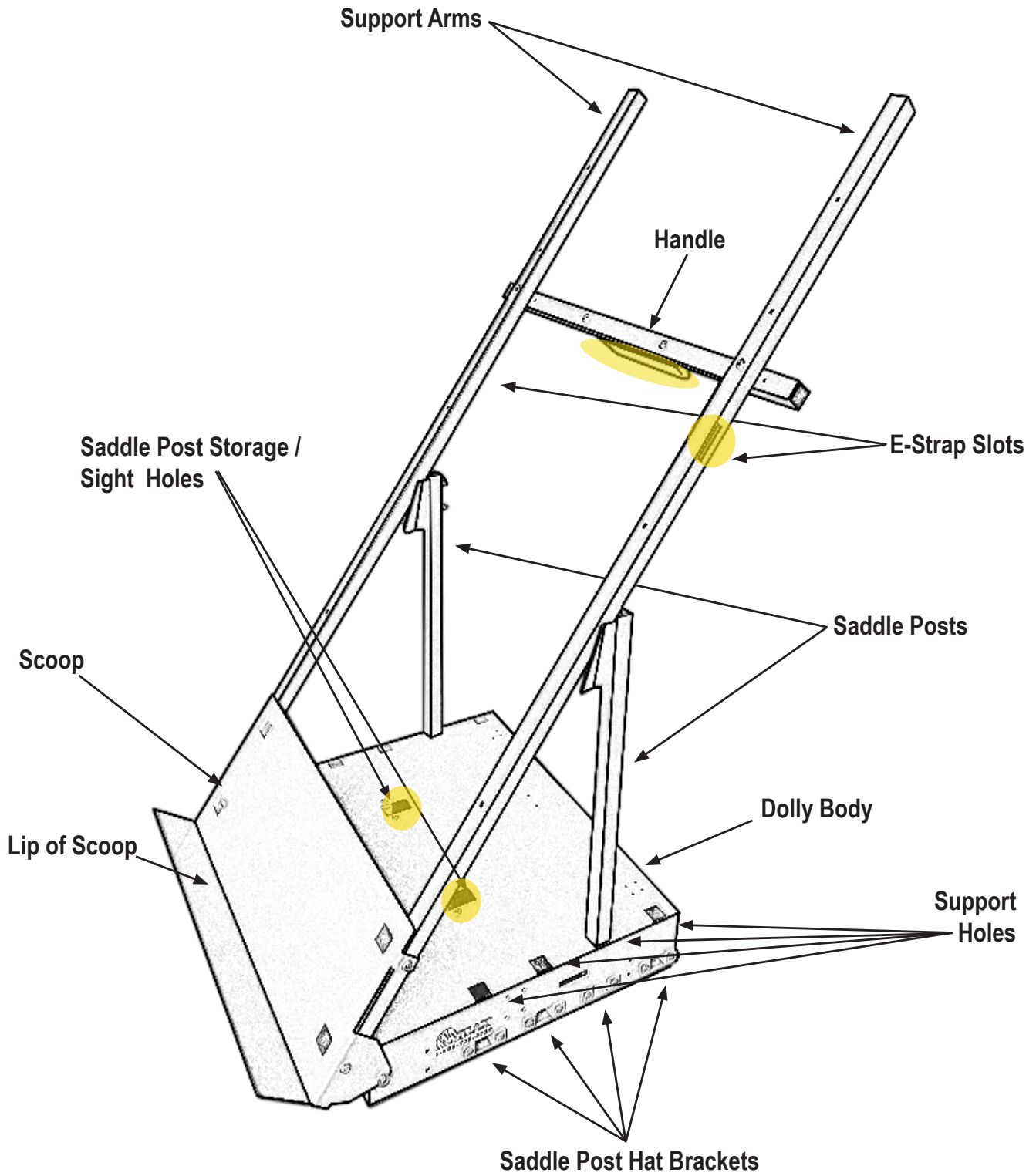

ABOUT THE SCOOP DOLLY

THE SCOOP DOLLY ALLOWS YOU TO EFFORTLESSLY LOAD AND MOVE:

- tall, long and narrow objects
- door units
- staircases
- window units
- vertical panel saws
- prefabricated walls
- top heavy objects
- (with the optional leverage step, pg. 8) bureaus, furniture and appliances over 3 feet tall

The Scoop Dolly operates like a pivoting hand truck on a dolly. Unlike standard hand trucks, the object can be moved in any direction, making long objects easier to move.

The Scoop Dolly can be left alone once loaded and tilted into position. No operator is necessary to support the load.

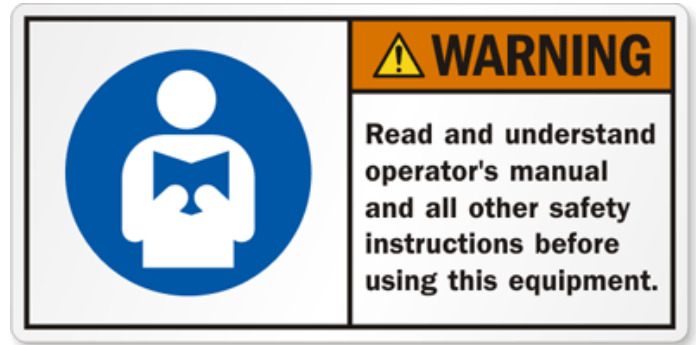

UNPACKING THE SCOOP DOLLY

When unpacking, CHECK TO MAKE SURE THAT THE DOLLY IS INTACT / UNDAUNAGED and that all ordered parts are included. If any parts are missing or broken, please call Saw Trax Manufacturing as soon as possible at 770-974-0021.

IMPORTANT WARNINGS AND SAFETY PRECAUTIONS



1. Use this tool for manufacturer's recommended use only. Use other than which is described may result in injury or property damage.
2. Do not exceed 800 lb. max. weight capacity (base model), or 1000 lbs. max capacity with optional 5th caster and braces.
3. CAREFULLY AND SMOOTHLY start, stop and change direction.
4. Be aware that loads in motion have more force/weight than stationary loads. Sudden or rapid load movement may briefly create excess load force and result in product failure and/or a tipping hazard.
5. EVENLY CENTER YOUR LOAD. This equipment is designed for evenly centered loads. Off-centering of loads can result in a dangerous operating condition and cause damage or injury.
6. If practicable, KEEP ONE HAND ON TOP OF LOAD being transported.
7. When possible, KEEP LOAD STRAPPED to dolly during transport (E-Strap, p.7).
8. Use extreme caution when handling loosely stacked/packaged loads.
9. Do not use when tired or under the influence of drugs or medication.
10. Always look in direction of travel.
11. Use caution when visibility is obstructed by load.
12. Ensure floor is clear of debris when moving a load.
13. When maneuvering a load, watch swing clearance near walls, racks, pillars and other obstacles.
14. SLOW DOWN FOR TURNS to eliminate load swing. The back of a long load may swing out when turning on an all-caster dolly. If possible, maneuver long loads with one person in front and one person in back to help steer. (Note: The directional wheel option (pg. 8) allows easier steering with one person for long loads.)
15. Do not use on uneven, sloped or slippery surfaces.
16. Be aware that the casters behave differently without a load than with a load.
17. DO NOT RIDE ON THIS EQUIPMENT. Do not carry passengers or lift personnel.
18. Maintain product labels and nameplates. These carry important safety information. If unreadable or missing, contact Saw





Trax Manufacturing for a replacement.

19. WHEN TILTING A LOAD onto the ground, move it slowly and prop it up against a wall or other stationary object as a brace.
20. When unloading high center of gravity (CG) loads, secure load to the scoop support arms for better control. High CG loads can pick up momentum during unloading and fall over away from the dolly and cause injury to people, or damage to the load or other objects.

SUGGESTIONS FOR SAFEST AND EASIEST USE

Plan and prepare for the job before attempting to load the dolly

- Be sure the Scoop Dolly can handle your load's weight and size (base model: 800 lbs. max); do not overload dolly
- Inspect dolly before each use for broken or bent areas and loose nuts/bolts
- If applicable, test brake operation before each use (pg.7)
- Dress Safely
 - * Wear sturdy shoes with nonskid soles to protect your feet from dropped loads and dolly wheels; ANSI-approved steel-toed shoes are recommended
 - * Wear gloves that will provide a good grip
 - * Avoid loose or baggy clothing that could catch in the dolly or cause tripping
- Ensure Load Balance And Stability
 - * Place heavy objects at the bottom
 - * Evenly center your load
 - * Position the center of gravity of the load and saddle posts rearward over the center of the dolly, so that all of the box casters bear the weight of the load
 - * Secure objects on dolly during transport to prevent shifting or falling

Operate Dolly Carefully to Minimize Physical Strain and Maximize Control

- Grip the handle firmly when loading, and if possible, keep one hand on top of the load
- Bend your knees and keep your back straight when loading or unloading
- Lean backwards to pivot the load onto the dolly when loading
- Walk, do not run when transporting a load
- Never brace or brake the dolly with your foot
- When traveling downhill, stay behind the dolly
- When traveling uphill, stay in front of the dolly
- Use a wall or other brace when tilting to unload (see Important Warning and Safety Precaution #19)
- "Keep Your Eyes on the Road" and Stay Alert
 - * Be on the lookout for other vehicles
 - * Keep yourself and the dolly wheels away from dock and platform edges
 - * Inspect the floor for obstacles, slippery spots, inclines, blind corners, or debris that could block casters

OPERATING THE SCOOP DOLLY

1. **ADJUST THE SADDLE POSTS (A) FOR THE LOAD.** The Scoop Dolly has saddle posts that can be adjusted to vary the angle of the load, to safely keep the center of gravity (CG) over the dolly. When unsure where to set the saddle posts initially, a good place to start is the third support hole from the scoop.

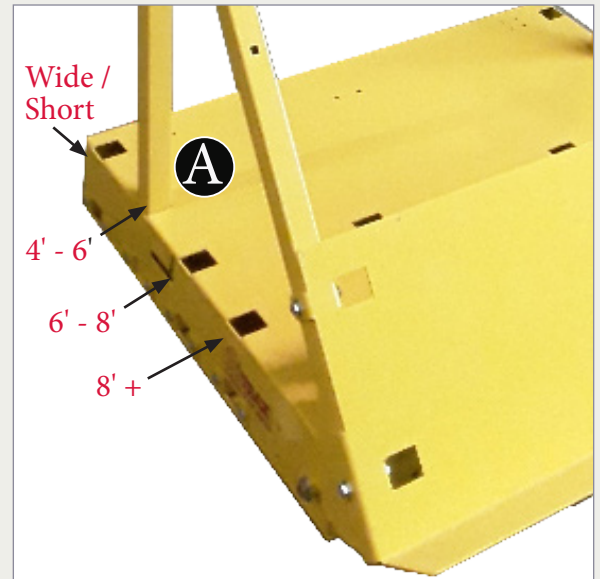
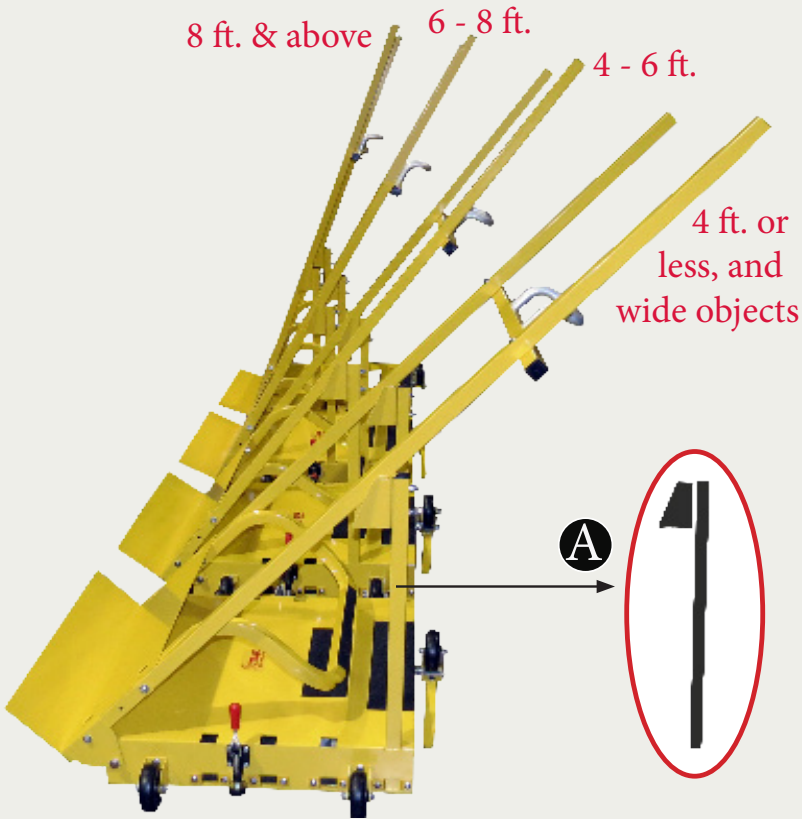

2. **POSITION THE SCOOP.** The Scoop Dolly has a pivoting, hand truck-like scoop (B) that is easy to slide under the load while the dolly body stays flat on the floor.

Slide the lip of the scoop under the load until the side of the load is against the support arms.

Tilting the load away from the dolly may be necessary to get the scoop lip under the load.

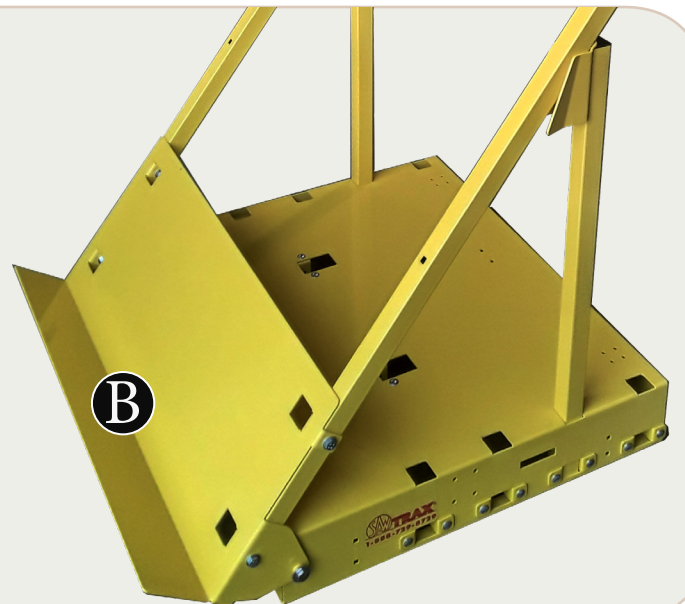

OPERATING THE SCOOP DOLLY

3. **BRACE THE LOAD.** Use your hand, a load puller stick (**C**) or strap (**D**), to hold the load against the scoop support arms.

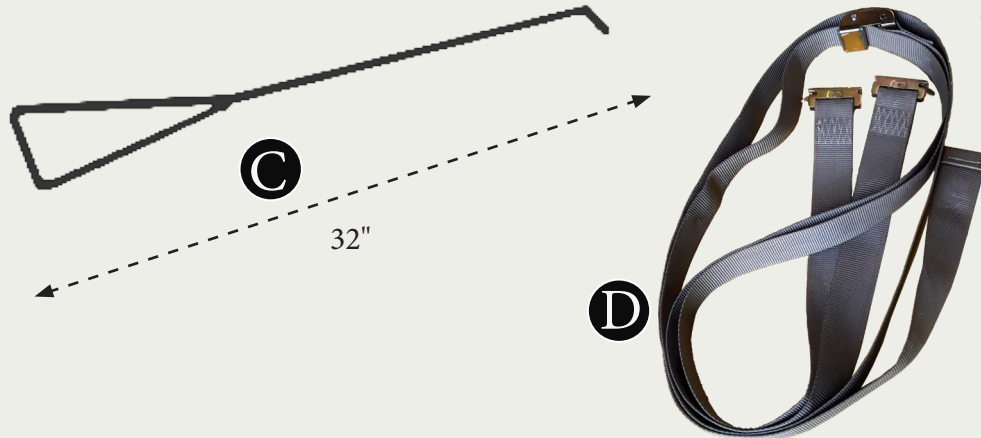

4. **TILT THE LOAD BACK ONTO THE SCOOP DOLLY.** Using the Scoop Dolly handle (**E**), tilt the scoop back and tilt the load back onto the support arms.

If the load will not stay back, set the load down and move the saddle posts back one or two positions.

The pivoting scoop (**B**) enables the casters of the dolly to remain on the floor and not become angled, which could cause the internal bearings to fail.



Note: When lifting or setting down heavy loads, the load side of the dolly may tilt down to the floor; this is normal.

HELPFUL FEATURES

OMNI DIRECTIONAL CASTERS (F)

4-inch omni-directional casters allow the load to be moved in any direction. This allows for exceptional maneuverability even in the tightest of spaces, around corners and through cluttered walkways.

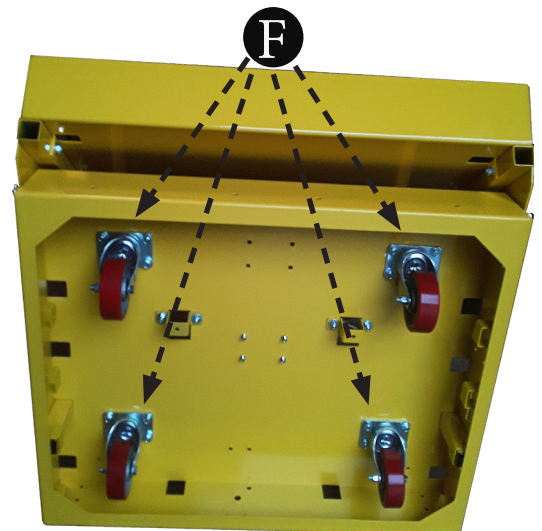

HELPFUL FEATURES (Continued)

E-STRAP FITTING (G)

Additional E-Strap slots are manufactured into the Scoop Dolly support arms, allowing strapping in of larger loads for secure transport.

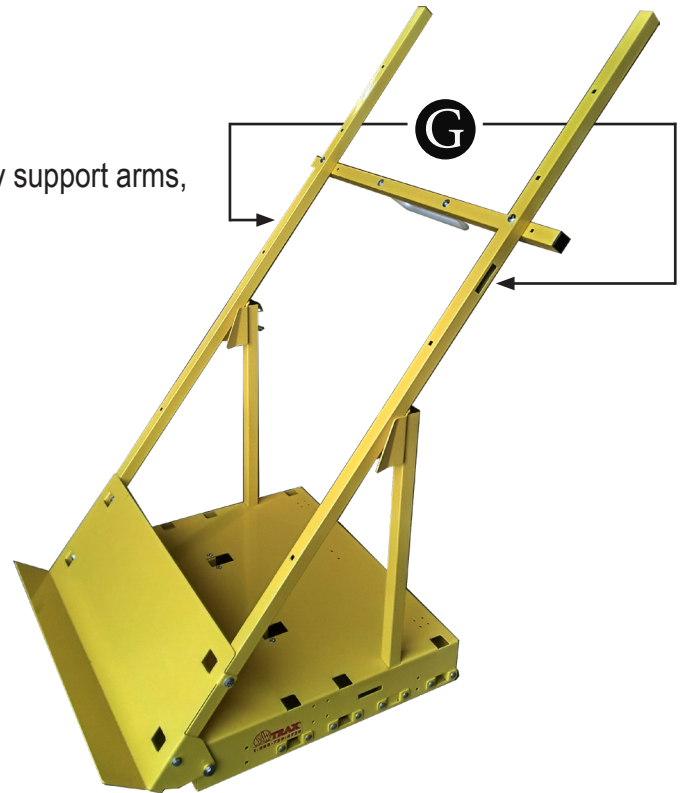

OPTIONAL UPGRADES

Call us or visit <https://www.sawtrax.com/product/scoopdolly/> for more information

DOCK TRANSITION WHEELS

For transitioning on uneven surfaces. Adds 4 wheels on sides of dolly **1**, and extra 5th caster **2** centered underneath the decking.

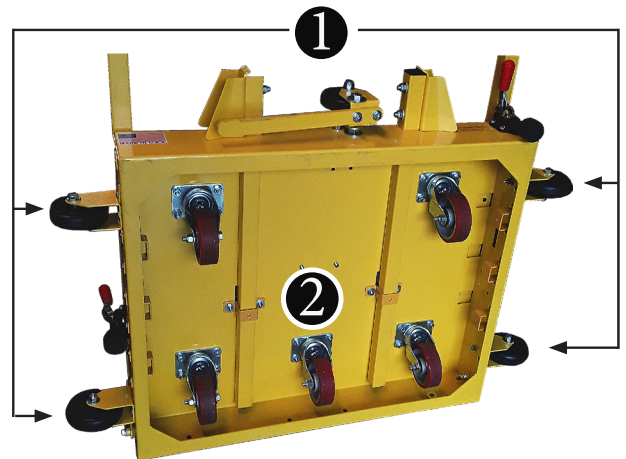

BRAKES

For stabilization, two built-in toggle clamps **3** are added to raise the dolly and take the weight off the casters.

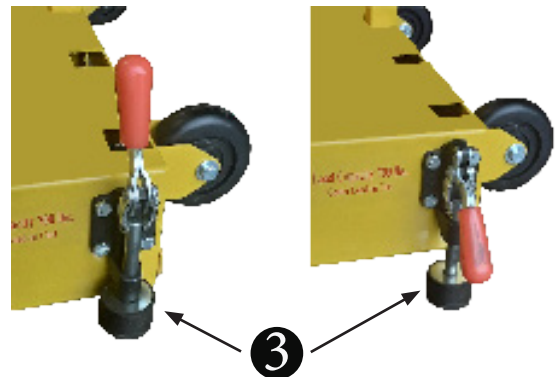

OPTIONAL UPGRADES (Continued)

Call us or visit <https://www.sawtrax.com/product/scoopdolly/> for more information

ADDITIONAL TRANSPORT WHEELS ⑧

For directional assistance capabilities when carrying shorter loads that have a lower center of gravity, additional wheels are added to the front edge of the scoop dolly body, behind the scoop lip plate.

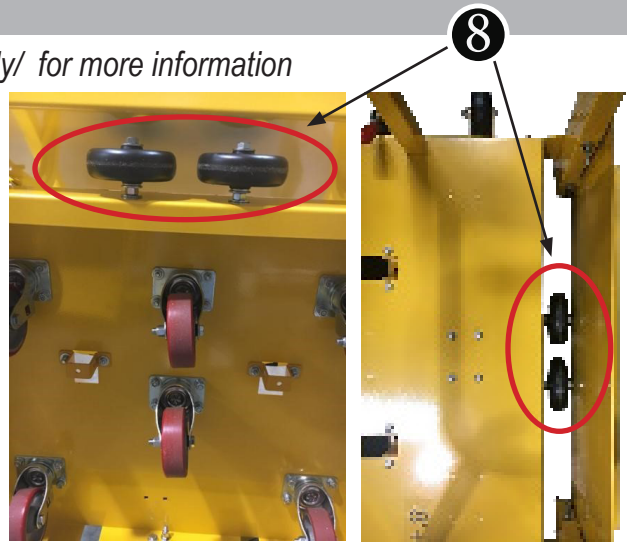

TRANSPORT / STORAGE OPTIONS

For folding and rolling the scoop, allowing for less transport and storage space requirements, and easy travel. Adds an additional latch ⑨, cradle positions for saddle post storage ⑩, and transport wheels (above) ⑧.

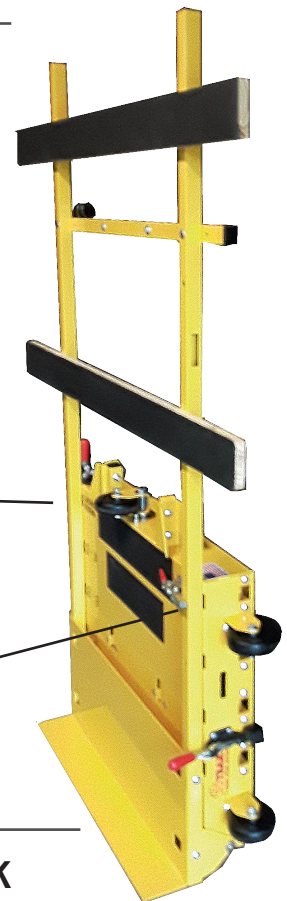
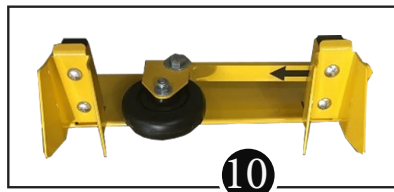

LOAD PULLER STICK



HEAVY DUTY L PULL HOOK



OPTIONAL UPGRADES (Continued)

Call us or visit <https://www.sawtrax.com/product/scoopdolly/> for more information

LEVERAGE STEP

Allows for easier tilting of large or heavy loads back onto the dolly. The built-in step ④ allows you to use your body weight to instantly create leverage, resulting in minimal pulling or physical strain.



DIRECTIONAL WHEEL

Eliminates "swing" issues when going around a corner for easy, one-person push operation. Uses an over-center design to lift one side of the dolly, taking that side's casters off the floor and putting the weight on the directional wheel ⑤.



**Note: This reduces the weight capacity of the dolly to 500 lbs.*

WEIGHT UPGRADE TO 1000 lb. LIMIT

An extra caster is added on the scoop side ⑥, totaling (3) casters on the scoop side. Two 1x4's with rubber padding are also added to the handle support arms of the dolly ⑦.

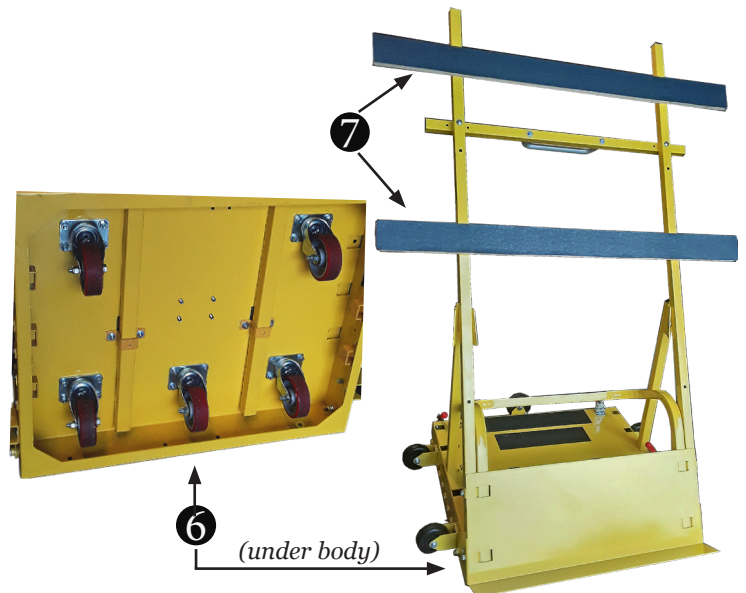

Revised 06/22/2020.

For information on the compatibility of the Scoop Dolly with any products introduced after this date, contact Saw Trax.

Warranty and Service (Carts and Dollies)

Saw Trax Mfg., Inc. warrants every product it sells against manufacturers' defects and each product is designed to give years of dependable service. Your new Cart or Dolly was built from the finest components available by our trained craftsmen.

Warranty Period:

The general warranty lasts for the time specified in the literature included with your product or on the official Saw Trax Mfg., Inc. branded website.

- Saw Trax Mfg., Inc. products carry a limited warranty which varies in duration based upon the product. (See *Product Listing with Warranty Period*)
- Accessories carry a limited warranty of 90 days from the date of receipt.
- Consumable items are defined as expendable parts or accessories expected to become inoperable within a reasonable amount of use and are covered by a 90-day limited warranty against manufacturer's defects.

Who is Covered:

This warranty covers only the initial purchaser of the product from the date of delivery.

What is Covered:

This warranty covers any defects in workmanship or materials subject to the limitations stated below. This warranty does not cover failures due directly or indirectly to misuse, abuse, accidents, normal wear-and-tear, improper repair, alterations or lack of maintenance. Use of these machines in the processing of metal or some other materials may void the warranty. This warranty gives you specific legal rights, and you may also have other rights which may vary from state to state.

Saw Trax Mfg., Inc. will repair or replace, at our discretion, any component that is determined to be defective.

Repair or replacement is limited to providing replacement parts from the factory. Saw Trax Mfg., Inc. assumes no responsibility for making repairs on site. Parts returned to the factory must be returned freight prepaid and include a Return Authorization (R.A.) number. Please call 770-974-0021 for a R.A. number.

Product Listing with Warranty Period:

- 90 Days- Parts, Consumable items
- 90 Days- Accessories
- 3 Year- Cart or Dolly Body

Note: Custom designed Carts/Dollies are exempt from warranty

How to Get Technical Support:

Please contact Technical Service by calling 888-SAW-TRAX. Please note that you will be asked to provide proof of initial purchase when calling. If a product requires further inspection, the Technical Service representative will explain and assist with any additional action needed.

More Information:

Saw Trax Mfg., Inc. is constantly adding new products. For complete, up-to-date product information, check with your local distributor or visit the Saw Trax Mfg., Inc. website.

Saw Trax Mfg., Inc. sells through distributors. The specifications listed in Saw Trax Mfg., Inc. printed materials and on the official Saw Trax Mfg., Inc. website are given as general information and are not binding. Saw Trax Mfg., Inc. reserves the right to effect at any time, without prior notice, those alterations to parts, fittings, and accessory equipment which they may deem necessary for any reason whatsoever.

Limitations on This Warranty:

SAW TRAX MFG., INC. SHALL IN NO EVENT BE LIABLE FOR DEATH, INJURIES TO PERSONS OR PROPERTY, OR FOR INCIDENTAL, CONTINGENT, SPECIAL, OR CONSEQUENTIAL DAMAGES ARISING FROM THE USE OF OUR PRODUCTS. SOME STATES DO NOT ALLOW THE EXCLUSION OR LIMITATION OF INCIDENTAL OR CONSEQUENTIAL DAMAGES, SO THE ABOVE LIMITATION OR EXCLUSION MAY NOT APPLY TO YOU.