



TRUCK STORAGE SOLUTIONS

# INSTALLATION MANUAL ALUMINUM & STEEL SIDE BOX

ATTENTION: PLEASE READ AND UNDERSTAND ALL INSTRUCTIONS AND WARNINGS BEFORE ASSEMBLING, INSTALLING OR USING THIS PRODUCT.

**MODELS** 164-X-03, 165-X-03, 174-X-03, 175-X-03, 178-X-03, 180-X-03, 184-X-03, 185-X-03

**Note:** X represents the color code for your model: 0 = Clear | 3 = White | 5 = Black | 52 = Matte Black | 6 = Gun Metal Gray



## ⚠ NOTICE

Use specific aluminum upfit components when installing WEATHER GUARD® products to aluminum truck beds. Follow additional instructions if mounting to an aluminum truck bed. There may be left over components depending on upfit.

Any modification or unintended use of this product shall immediately void all manufacturers warranties. Manufacturer disclaims all liability for injuries to persons or property resulting from any modification to, or unintended use of this product.

## ⚠ WARNING

Prior to drilling, so as not to cut or puncture fuel tanks, fuel lines, electric wires, etc., check under vehicle for locations. All floor mounting bolts near the gas tank area should be installed from the underside of the vehicle, to guard against the gas tank being punctured in the event of a collision. This would mean not using Blind Fastener in this area. Holes drilled in this area should be 3/8".

## ⚠ DANGER

Danger of explosion. Do not use this product for storing or transporting flammables, explosives, hazardous materials, or hazardous waste, such as containers of gasoline, solvents, gun powder, dynamite, propane tanks, acetylene tanks and cutting torches. This product is only intended and safe for use in storing and transporting small tools, equipment and other similar materials. Any modifications made to, or unintended use of this product, could create a hazardous condition that can cause death, serious personal injury or property damage.

## ⚠ CAUTION

Before marking the leg mounting holes, check inside the box for location of gas spring housing and components that may obstruct safe drilling. To keep debris out of your eyes when checking the underside of the vehicle, or when drilling, always wear protective eyewear.







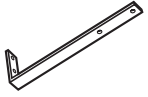
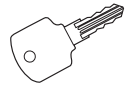
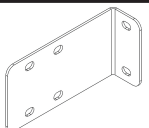

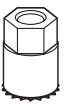
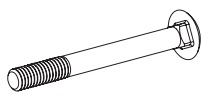

## TOOLS REQUIRED

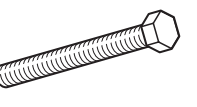
- Electric Drill
- Bits: 3/16", 3/8", 1/2"
- Deep Well Ratchet Wrench - 1/2"
- Open or Box End Wrench - 1/2", 9/16"
- Carpenter's Square
- Zinc Rich Primer



## PARTS LIST

				
(2) Leg	(2) Key	(1) Corner Bracket		

## BOLT KIT

				
(8) 5/16-18 Blind Fastener	(1) Installation Tool	(2) 5/16-18 x 3" Carriage Bolt	(8) 5/16-18 x 1-1/4" Hex Head Bolt	(1) 5/16-18 x 2-1/4" Black Oxide Bolt
				
(8) 5/16" Flat Washer	(2) Fender Washer	(2) 5/16-18 Nylon Lock Nut	(1) 3/4" Round Cap Plug	(8) 5/16" Lock Washer
		Aluminum Bed Upfit Kit (See contents below)		
(1) "J" Bolt	(2) Mounting Clamp			

## ALUMINUM BED UPFIT KIT PARTS LIST (COMPONENT OF BOLT KIT)

				
(4) Vinyl Tape	(1) Zinc Rich Primer	(8) 1/2" x 1" Plastic Washer	(4) 11/32" x 7/8" Plastic Washer	(8) 5/16" x 3/4" Plastic Washer

## BLIND FASTENER INSTALLATION

Place a drop of oil on black oxide bolt for lubrication before assembling.

Place the Blind Fastener in the hole and use 1/2" or 7/16" wrench to tighten black oxide bolt until fastener is fully seated (it will start out hard and get easier as fastener "bulbs" out).

Make sure the Blind Fastener and Installation Tool do not turn during installation.

## ALUMINUM TRUCK BED INSTALLATION

Coat drilled holes with Zinc Rich Primer. Insert Blind Fastener through one 1/2" x 1" plastic washer. Insert Blind Fastener into drilled hole. Place second 1/2" x 1" plastic washer through the bottom of the Blind Fastener. Continue following installation instructions above to install Blind Fasteners.

**Note:** If your truck bed is constructed of aluminum, use zinc rich primer to coat drilled holes.

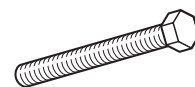

**Black Oxide Bolt**



**Flat Washer**

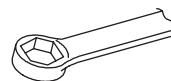

**9/16" Wrench**

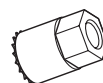

**Installation Tool**



**Blind Fastener**

# INSTALLATION INSTRUCTIONS

**⚠ WARNING: ONCE A LOCK IS CODED IT CANNOT BE CHANGED! ⚠**

## CODING THE LOCKS - Easy 3-step guide

### ① START

Read, then remove the label, open box lid, then insert key.

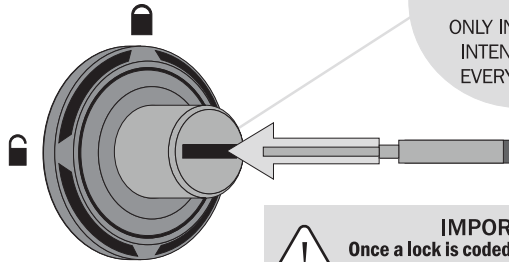

**WARNING**  
DO NOT REMOVE UNTIL  
READY TO CODE GRV  
ONLY INSERT KEY  
INTENDED FOR  
EVERYDAY USE

**IMPORTANT:**  
Once a lock is coded it cannot be changed.  
Make sure to register your key code

### ② CODING THE LOCK

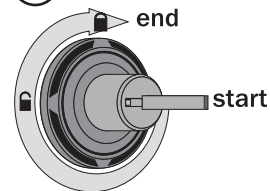

Turn key clock-wise a full 3 quarters of a circle

**USEFUL HINT:**  
When the key is coding there will be a 'clicking' sound

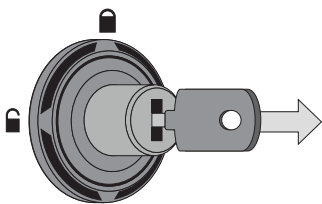

The box is now locked with the key **permanently** coded.  
Remove key.

### ③ TESTING THE LOCK

Fully insert key again.

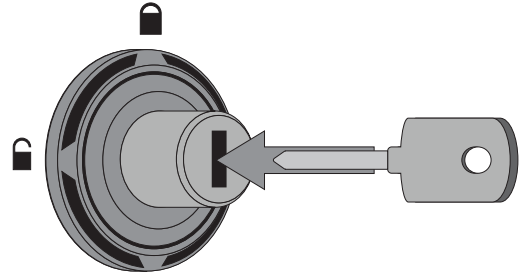

Turn key counter-clockwise 1/4 turn to unlock.

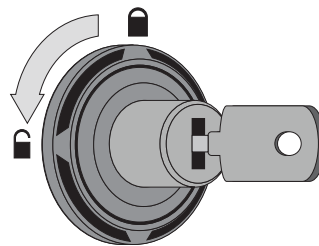

Turn key clockwise 1/4 turn to lock.

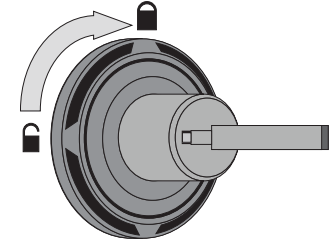

**USEFUL HINT:**  
Lock and unlock the box 5 times to ensure it works.  
Remove key fully between each test.

## STEP 1 Locate Box in Truck Bed

Mount saddle/cross box first (if applicable). Support box with blocking until mounted.

Square box to bed and level box so top is horizontal when viewed from rear. Leave 1/8" gap between side box and saddle/cross box (if applicable). Make sure cover opens fully without interference.

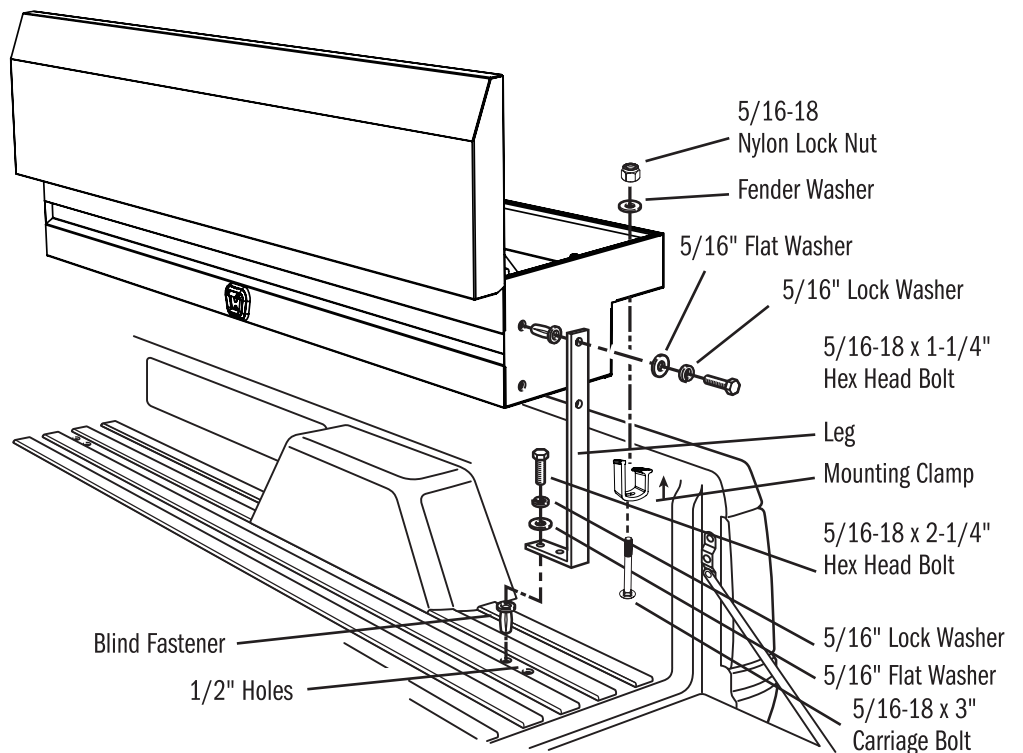

# INSTALLATION INSTRUCTIONS (continued)

## STEP 2 Mark and Drill Mounting Holes

- Note:**
- To maintain full floor width between wheel wells, legs should be aligned with the inside edge of the wheel wells. The foot of the leg must be squarely mounted on or between the tops or floor ribs.
  - Fasten leg mounting feet directly to bed floor, not liners or bed mats.

Position rear leg as shown on page 3. Use square to ensure vertical orientation. Mark both holes at top of leg and both holes in truck bed floor.

Repeat leg placement and marking process for other leg. If installing side boxes with a saddle or cross box, the front leg can be replaced with a corner bracket.

Remove box from truck. Drill all marks on box and truck with 3/16" drill bit. Redrill all holes with 1/2" drill bit. Install all Blind Fasteners.

Reposition box to align with drilled holes and secure with 5/16-18 x 1-1/4" Hex Head Bolts.

**Note:** If your truck bed is constructed of aluminum, use rich primer to coat drilled holes.

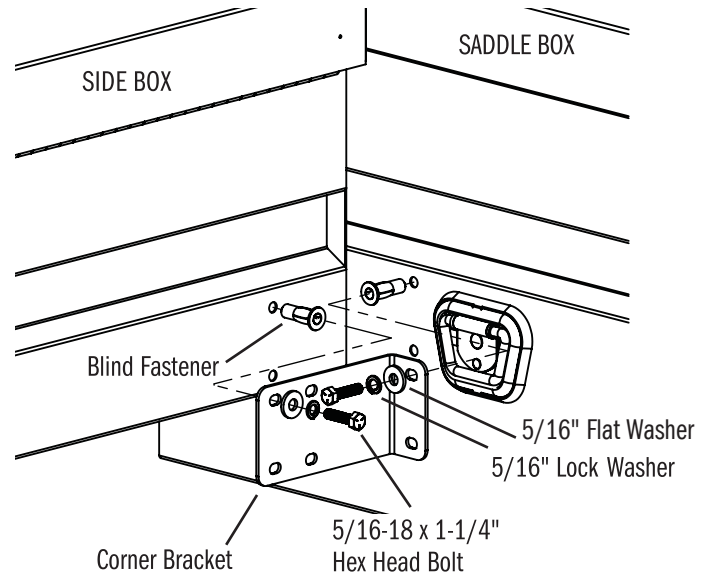

### ALUMINUM TRUCK BED INSTALLATION:

Follow additional instructions if mounting to an aluminum truck bed as explained in the Blind Fastener Installation on page 2.

## STEP 3 Attach Box to Truck Bed

Attach (2) mounting clamps with bolt, washer, and lock nut as shown in figure to the right.

If a stake pocket interferes with any mounting clamp location, it will be necessary to drill the stake pocket with a 1/2" drill bit, with the top of the hole even with the bottom edge of the bed lip.

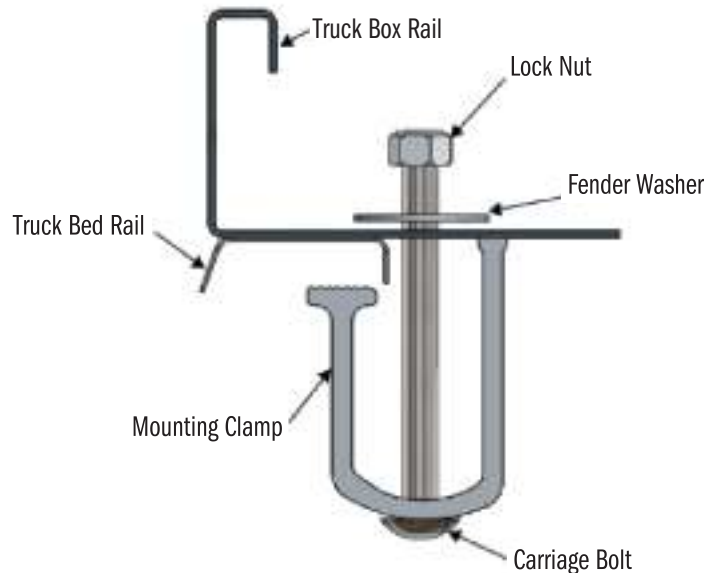
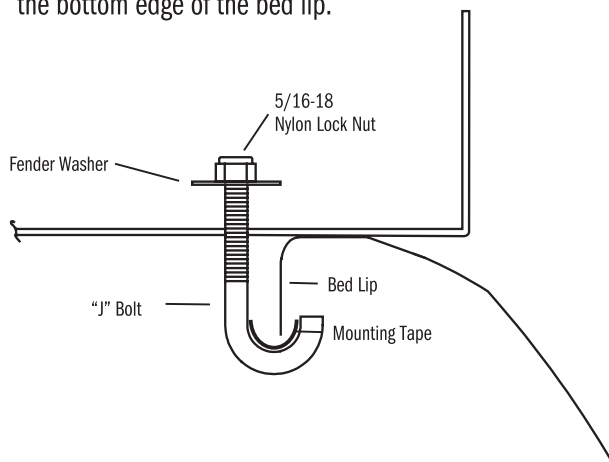

### ALUMINUM TRUCK BED INSTALLATION:

For aluminum truck beds, use vinyl tape as a barrier between the J-bolt and aluminum bed.

## FEATURE OPERATION

### Lock System

The WEATHER GUARD® 1KEY ULTRALOCK is designed to provide maximum security, while providing ease of use and years of reliable service.

When the button is pressed in the unlock mode, the latches are activated and the cover opens.

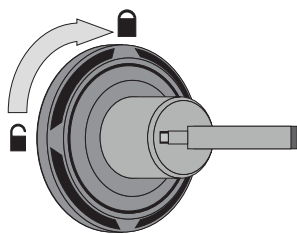

#### Locked

Turn the key clockwise to the locked position as indicated on the lock bezel.

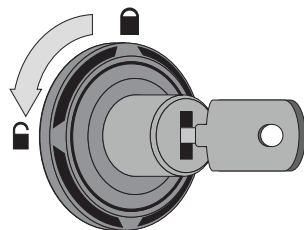

#### Unlocked

Turn the key counter-clockwise to the unlocked position as indicated on the lock bezel. It is now ready to release the latches when pressed.

### Latch System

The WEATHER GUARD® Latch System utilizes automotive grade latches in conjunction with high strength latch strikers to ensure maximum security. The WEATHER GUARD® Latch System is designed to open with a single touch of the button, and close securely. Expect years of reliable service from the WEATHER GUARD® Latch System with only minimal maintenance: Lubricate latch pivot points bi-annually with white grease. If latch strikers are accidentally knocked out of alignment, simply use a mallet to re-align.

### 12V Electrical Access

WEATHER GUARD® Truck Boxes are equipped with a 12 volt electrical access grommet for easy electrical accessory fit-ups. To use, simply cut along one or more perforations in the rubber grommet and run wire through.



## ⚠ WARNING

### Extension Cord

- Follow all Extension Cord manufacturer's warnings and instructions.
- DO NOT insert extension cord through hole without grommet in place.
- Only use a three-wire extension cord with all three prongs intact. Never remove the round grounding prong.
- Extension cord must be connected to a 120 Volt GFCI protected outlet with proper ground. If GFCI outlet is not available, use an extension cord with GFCI protection built in.
- Check the insulation and plugs of extension cord before using. DO NOT use cord if it is worn or damaged.
- DO NOT overload extension cord.
- Remove extension cord from the grommet hole before moving or transporting saddle/cross box.
- Only use an extension cord that is rated for outdoor use.
- DO NOT connect extension cord to outlet that also supplies critical safety equipment with power.

### Cordless Power Tool Battery Chargers

- See Charger's Owner's Manual for proper use and care of charger and batteries. Follow all warnings and instructions provided with your battery charger.
- Place chargers and electrical connections in tray.
- Chargers are dry location use only. DO NOT expose to liquid, vapor, or rain. Should your charger become wet, DO NOT attempt to use.
- Unplug extension cord from supply before handling wet charger or cords.
- Only use chargers and batteries that are intact and operating properly.
- DO NOT touch metal prongs when plugging charger into extension cord.
- Keep flammable materials like paper or rags away from charger, cords or connections.
- DO NOT place or attempt to charge lead acid, car type batteries in saddle/cross box.

# WERNER CO. LIMITED LIFETIME WARRANTY FOR WEATHER GUARD® PRODUCTS

## WEATHER GUARD® Products – Limited Lifetime Warranty

(Purchased on or after 1/1/2009)

WERNER CO. (the “Manufacturer”) warrants to the original purchaser only that WEATHER GUARD® Truck and Van Products (the “WEATHER GUARD® Product”) will be free from defects in material and workmanship from the date of purchase and continuing for the expected lifetime of the WEATHER GUARD® Product. A copy of the original sales receipt must be supplied to the Manufacturer at the time a warranty claim is made. This warranty terminates if the original purchaser transfers the WEATHER GUARD® Product to any other person.

### What is Covered

All WEATHER GUARD® Products identified above that are purchased on or after January 1, 2009.

### What We Will Do To Correct Problems

Subject to the limitations and exclusions described in this limited warranty, the Manufacturer will remedy defects in materials or workmanship by providing one of the following remedies at its option and without charge to the original purchaser for parts or labor: (a) repairing the defective portion of the WEATHER GUARD® Product or (b) replacing the entire WEATHER GUARD® Product. In addition, the Manufacturer may elect at its option, not to repair or replace the WEATHER GUARD® Product, but rather issue to the original purchaser a refund equal to the purchase price paid for the WEATHER GUARD® Product or a credit to be used toward the purchase of a new WEATHER GUARD® Product.

### What is Not Covered

This limited warranty expressly excludes:

- Defects caused by normal wear and tear, cosmetic rust, scratches, accidents, unlawful vehicle operation, or modification to the product, or any types or repair of a WEATHER GUARD® Product other than those authorized or provided by the Manufacturer.
- Defects resulting from conditions beyond the Manufacturer’s control including, but not limited to misuse, overloading, or failure to assemble, mount or use the WEATHER GUARD® Product in accordance with the Manufacturer’s written instructions or guidelines included with the WEATHER GUARD® Product or made available to the original purchaser.
- Damage to the contents of the box or vehicle.
- TO THE EXTENT PERMITTED BY LAW, IN NO EVENT SHALL THE MANUFACTURER BE LIABLE FOR ANY INCIDENTAL, SPECIAL, INDIRECT, OR CONSEQUENTIAL DAMAGES, INCLUDING ANY ECONOMIC LOSS, WHETHER RESULTING FROM NONPERFORMANCE, USE, MISUSE OR INABILITY TO USE THE WEATHER GUARD® PRODUCT OR THE MANUFACTURER’S NEGLIGENCE.

### No Other Express Warranty Applies

This Limited Lifetime Warranty is the sole and exclusive warranty for WEATHER GUARD® Products. No employee, agent, dealer, or other person is authorized to alter this warranty or make any other warranty on behalf of WERNER CO.

### Notification Procedures

If the WEATHER GUARD® Product does not conform with the terms of this limited warranty, the original owner must promptly notify the Manufacturer in writing upon discovery of the nonconformity. In order to receive the remedies under this limited warranty, the warranty claim must describe the nature of the nonconformity, and a copy of the original sales receipt, invoice, bill or other proof of purchase must accompany the claim. Repairs or modifications made to the WEATHER GUARD® Product by other than the Manufacturer or its authorized agent will nullify this limited warranty. Coverage under this limited warranty is conditioned at all times upon the owner’s compliance with these required notification and repair procedures. Warranty claims must include reciprocal contact information and may be made via certified mail to:

Werner Co.

Attn: Weather Guard® Warranty Claims

555 Pierce Road, STE 300, Itasca, IL 60143

[weatherguard.com](http://weatherguard.com)

If you have any questions, please call toll free at 1-800-456-7865

