

# **Item # BS LC24BSET, BS LC24CSET, BS LC24GSET Assembly Instructions**

**Max Weight Capacity 330 lbs**



## **READ ALL INSTRUCTIONS AND WARNINGS BEFORE USING THIS PRODUCT.**

This manual provides important information on proper operation & maintenance. Every effort has been made to ensure the accuracy of this manual. These instructions are not meant to cover every possible condition and situation that may occur. We reserve the right to change this product at any time without prior notice.

**IF THERE IS ANY QUESTION ABOUT A CONDITION BEING SAFE OR UNSAFE,  
DO NOT USE THIS PRODUCT!**

## **HAVE QUESTIONS? NEED ASSISTANCE? CONTACT CUSTOMER SERVICE.**





If you experience a problem, have questions or need parts for this product, visit our website <http://www.amerihomebrand.com> or call Customer Service at 1-636-532-9888, Monday-Friday, 8 AM - 4 PM Central Time, or email: [info@amerihomebrand.com](mailto:info@amerihomebrand.com). A copy of the sales receipt is required.

**KEEP THIS MANUAL, SALES RECEIPT & APPLICABLE WARRANTY FOR FUTURE REFERENCE.**

## ASSEMBLY INSTRUCTIONS

Each chair uses the following pieces. Confirm all pieces are included before starting assembly.

- 1 each Seat (A)
- 4 each Screw (B)
- 1 each Hex Wrench M6 (C)
- 1 each Frame (D)
- 4 each Spacer (E)

<p>1 PC SEAT</p>  <p><b>A</b></p>	<p>4 PCS SCREW(M6X25mm)</p>  <p><b>B</b></p>	<p>1 PC HEX WRENCH M6</p>  <p><b>C</b></p>
<p>1 PC FRAME</p>  <p><b>D</b></p>	<p>4 PCS SPACER(M6X18mm)</p>  <p><b>E</b></p>	

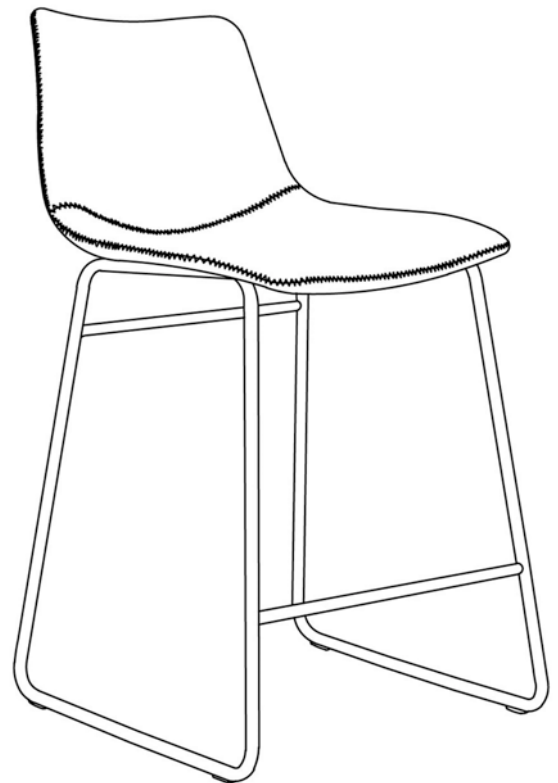
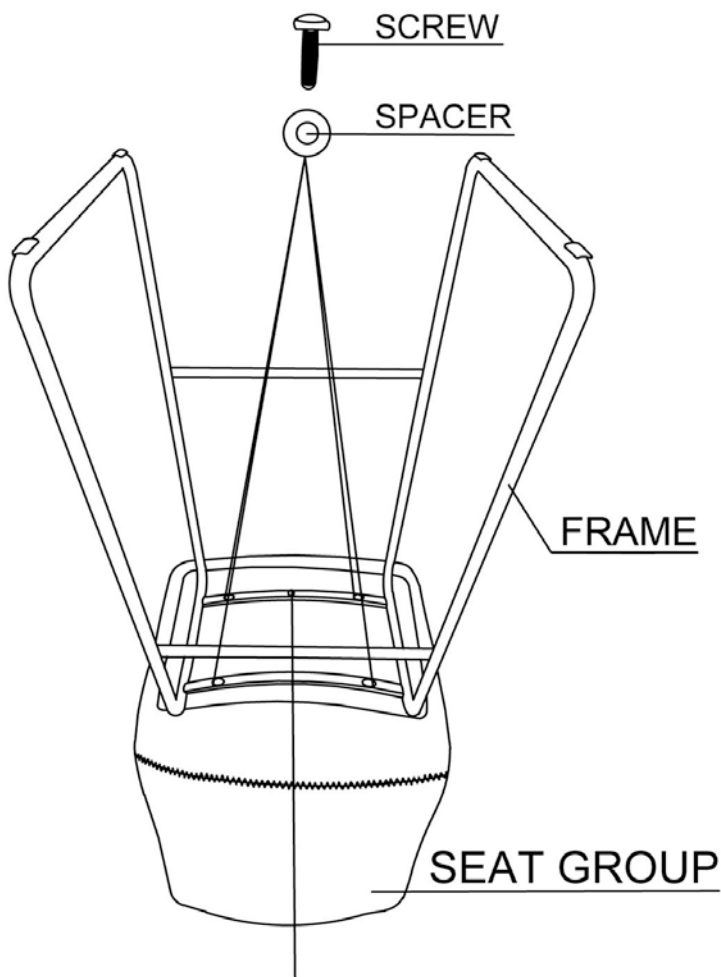

Turn over the seat and frame, put the frame on the seat.  
Connect them using four pieces screws & spacers using hex wrench.

During assembly, do not over tighten screws.