

# CARDINAL

CPS435  
BACKPACK SPRAYER

Operation Manual

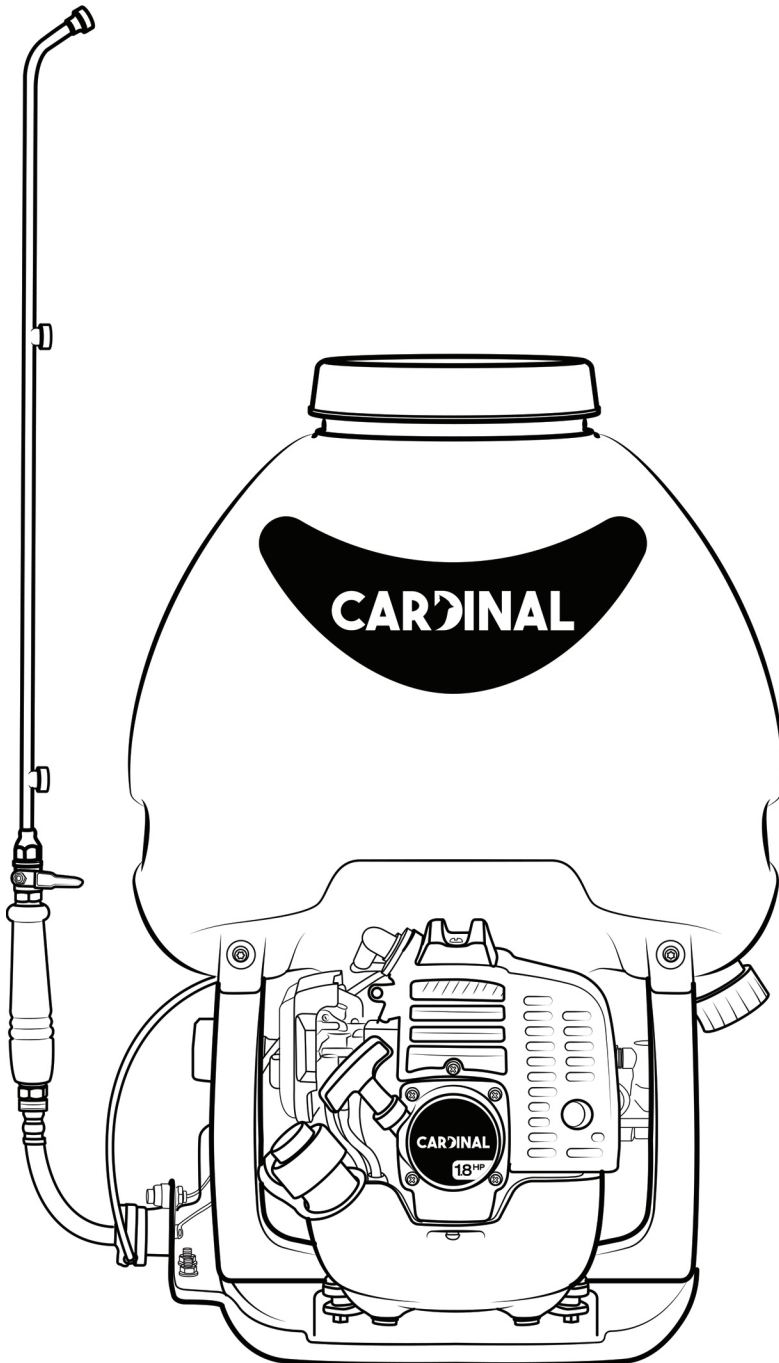

SPANISH MANUAL  
ON PAGE 32

MANUAL ESPAÑOL  
EN LA PÁGINA 32

For safe operation follow all safety precautions in the CPS435 Backpack Sprayer Operation Manual. Improper use can cause serious injury.

## **⚠ WARNING**

FOR USE WITH WATER-BASED OR WATERBORNE COMPOUNDS ONLY.

DO NOT SPRAY SOLVENT BASED OR EXPLOSIVE LIQUIDS. FAILURE TO COMPLY MAY CAUSE SERIOUS BODILY HARM OR DEATH.

READ OWNER'S MANUAL BEFORE OPERATION

# TABLE OF CONTENTS

<b>TABLE OF CONTENTS</b>	<b>2</b>
<b>QUICK ASSEMBLY GUIDE</b>	<b>4</b>
<b>OPERATOR PRECAUTIONS</b>	<b>5</b>
Equipment Warnings	5
Chemical Handling	5
<b>WARNINGS</b>	<b>6</b>
<b>SAFE OPERATION</b>	<b>7</b>
<b>QUICK START GUIDE</b>	<b>8</b>
<b>TECHNICAL SPECIFICATIONS</b>	<b>9</b>
<b>MAIN APPLICATIONS</b>	<b>9</b>
Features	9
Intended Uses	9
Target Pests	9
<b>SAFE SPRAYING AND PROTECTIVE GEAR</b>	<b>10</b>
<b>STARTING THE ENGINE</b>	<b>11</b>
<b>STOPPING THE ENGINE</b>	<b>11</b>
<b>TROUBLESHOOTING</b>	<b>12</b>
Engine Troubleshooting Guide	12
Spraying Troubleshooting Guide	13
<b>PUMP QUICK FIX GUIDE</b>	<b>14</b>
<b>CLEANING AND STORAGE</b>	<b>15</b>
<b>PROPOSTION 65</b>	<b>16</b>
<b>EPA WARRANTY</b>	<b>16</b>
<b>TOMAHAWK WARRANTY</b>	<b>20</b>
<b>PARTS MANUAL</b>	<b>21</b>
<b>MANUAL DE OPERACIÓN (Spanish Manual)</b>	<b>32-57</b>
<b>TOMAHAWK PRODUCT CATALOG</b>	<b>58</b>

# PRÓLOGO

<b>PRÓLOGO</b>	<b>2</b>
<b>MANUAL DE OPERACIÓN (MANUAL DE INGLÉS)</b>	<b>4-31</b>
<b>GARANTÍA DE EPA</b>	<b>16</b>
<b>GARANTÍA DE TOMAHAWK</b>	<b>20</b>
<b>MANUAL DE OPERACIÓN (MANUAL DE ESPAÑOL)</b>	<b>32</b>
<b>GUÍA PARA INSTALACIÓN DE PUNTA DOBLE</b>	<b>34</b>
<b>PRECAUCIONES PARA EL OPERADOR</b>	<b>35</b>
Advertencias sobre el equipo	35
Manejo de Químicos	35
<b>ADVERTENCIAS</b>	<b>36</b>
<b>OPERACIÓN SEGURA</b>	<b>37</b>
<b>GUÍA RÁPIDA PARA LA OPERACIÓN</b>	<b>38</b>
<b>ESPECIFICACIONES TÉCNICAS</b>	<b>39</b>
<b>APLICACIONES PRINCIPALES</b>	<b>39</b>
Características	39
Usos Previstos	39
Tipo de Plagas	39
<b>FUMIGACIÓN SEGURA Y EQUIPO DE PROTECCIÓN</b>	<b>40</b>
<b>ENCENDIDO DEL MOTOR</b>	<b>41</b>
<b>APAGUE EL MOTOR</b>	<b>41</b>
<b>SOLUCIÓN DE PROBLEMAS</b>	<b>42</b>
Solución de Problemas para el Motor	42
Solución de Problemas de Rociar/Pulverizar	43
<b>GUÍA RÁPIDA PARA REPARACIÓN DE LA BOMBA</b>	<b>44</b>
<b>LIMPIEZA DE LA FUMIGADORA Y ALMACENAJE</b>	<b>45</b>
<b>PROPUESTA 65</b>	<b>45</b>
<b>LISTA DE REPUESTOS</b>	<b>46</b>
<b>CATÁLOGO TOMAHAWK</b>	<b>58</b>

# CARDINAL

## CPS435: Assembly Guide



**1** Remove all parts from the box.  
(You will not need all pieces for assembly).

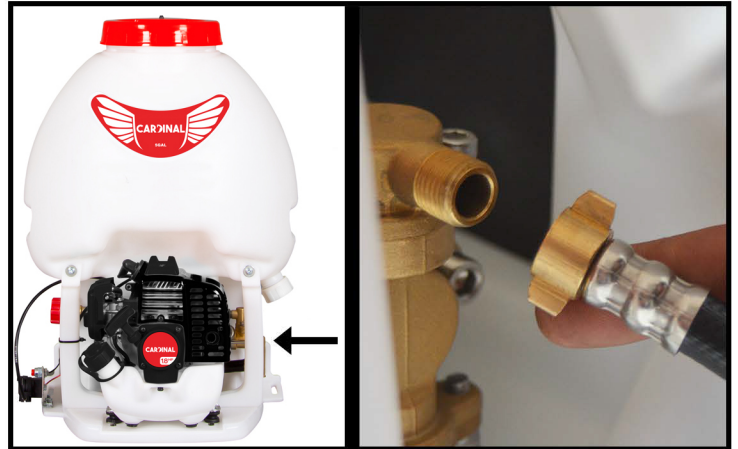

**2** Attach 1 hose directly to the sprayer's pump.  
Twist clockwise.



**3** Fasten the sprayer attachment to the valved end of the hose.  
**\***



**4** To attach the backpack straps, slip the strap's end underneath the back bar.



**5** Feed the strap's end through the buckle.  
Cinch tightly and repeat for the 2nd strap.



**6** Your backpack sprayer is now ready for work.

**\*** This manual may be used for Cardinal fogger, foundation, conical, and mist gun attachments.

## OPERATOR PRECAUTIONS

1. This product emits carbon monoxide, an invisible and odorless toxin. Do not run this product indoors at any time.
2. Always turn engine off before adding fuel to the tank.
3. To avoid electrocution, do not touch the cap of the spark plug or wiring while the engine is on.
4. Do not touch the surface of the muffler and cylinder while the engine is running. It is extremely hot.
5. Do not spill pesticide or chemicals when filling or the emptying tank.
6. Keep the area clear of people, children, and pets during operation of this machine.

## Equipment Warnings

1. The CPS435 Backpack Sprayer's 2 stroke engine runs on a 50:1 fuel mix. It uses 91 octane gas and two cycle engine oil.
  - a. **Note:** 50:1 pre-mix fuel is ideal for this product as it contains fuel stabilizer to ensure longevity of the equipment. Premix fuel can be found at your local hardware store or auto shop.
2. After starting the engine, keep the throttle at a low speed for several minutes before running at full throttle.
3. Gasoline is an extremely flammable fuel. When operating keep away from any flames. Do not smoke while operating.
4. Do not spray in the direction of others.
5. Understand the operation of the machine and understand how to shut off the equipment quickly in case of an emergency.

## Chemical Handling

1. Wear ear protection
2. Wear eye protection
3. Use a respirator to protect mouth and face against dust and chemicals
4. Wear closed toed protective shoes
5. Wear pants and a long sleeve shirt to avoid chemical contact with arms and legs
6. Wear protective gloves to avoid contact with chemicals
7. After operating the machine, wash hands and clothing immediately

## WARNINGS

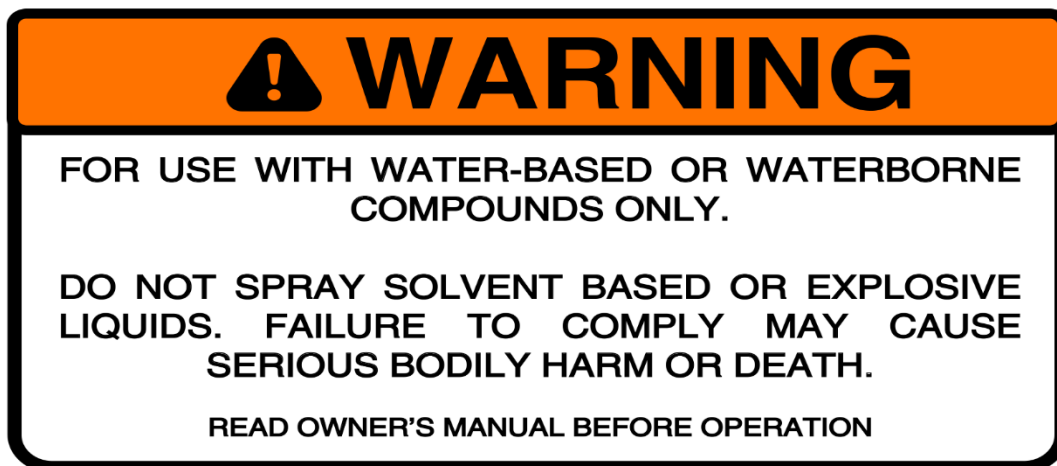

This backpack sprayer is meant for use with water-based or waterborne compounds only. Do not spray solvent-based or explosive liquids with this sprayer. Failure to comply may cause serious bodily harm or death.



Do not spray in the direction of others, as the chemicals used with this sprayer may be harmful to humans and animals.



**Toxic exhaust fumes may be colorless and odorless** and contain unburned hydrocarbons and benzol. Never operate the machine in enclosed or poorly ventilated locations

During operation, the muffler or catalytic muffler and surrounding cover may become extremely hot. Avoid contact during and immediately after operation. Always keep exhaust area clear of flammable debris. Allow the engine and muffler to completely cool before performing any maintenance activities. After working, wash hands and clean all clothing.

**NOTE: Residual pesticide can stain what you touch.**

Open the fuel cap carefully to allow any pressure build up in the tank to release slowly and avoid fuel spillage.

Fuel your backpack sprayer only in well-ventilated areas. If fuel spill is spilled, wipe the machine immediately – if fuel gets on clothing, change clothing immediately.



Check for leakage. To reduce the **risk of serious or fatal burn injuries**, do not start or run the engine until the leak is fixed.



After fueling, tighten down the screw-type fuel cap as tight as possible.

This reduces the risk of unit vibrations causing the fuel cap to loosen or come off and spill fuel.

## BACKPACK SPRAYER SAFE OPERATION

### Fueling Precautions

- This engine is certified to operate on unleaded gasoline and two-stroke engine oil at a mix ratio of 50:1.
- This engine requires a mixture of high-quality gasoline and two- stroke air cooled engine oil.
- Use mid-grade unleaded gasoline with a minimum octane rating of 91 and no more than 10% ethanol content.
- Keep the fuel tank far away from flames or sparks. Do not smoke near fuel.
- When adding pre-mixed fuel to the engine, use a funnel to avoid spillage.
- When the machine is running, do not add more fuel to the fuel tank.
- Open the fuel cap carefully to allow and pressure build-up in the tank to release slowly and avoid fuel spillage.
- At the end of a season, drain all fuel from gas tank and use fuel stabilizer to ensure a clean carburetor for your next season.



NOTE: **Gasoline is an extremely flammable fuel.** Keep clear of flames. Do not spill any fuel. Do not smoke near the engine or fuel. Always **shut off the engine** before refueling. Do not fuel a hot engine – **fuel may spill and cause fire.**

1

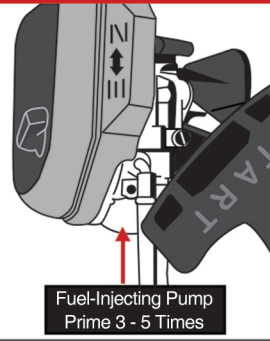
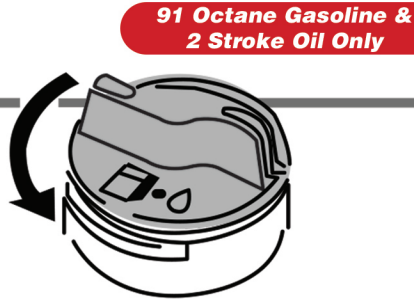

Pour 50:1 Pre Mix 2 Stroke engine fuel into the fuel tank

2



Slowly pour pesticide liquid into the chemical tank

3

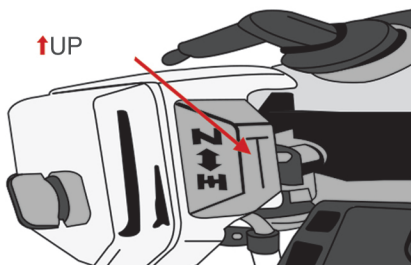

Place the choke into the closed position

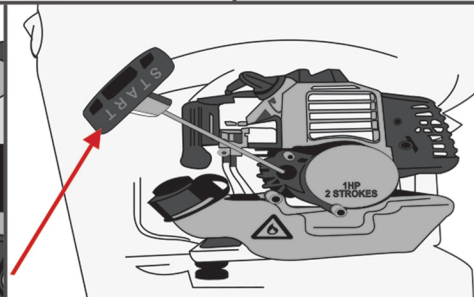

Pull the recoil starter 1-3 times until the engine is running

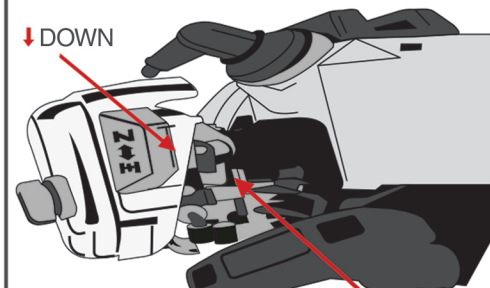

Move the choke into the open position

4

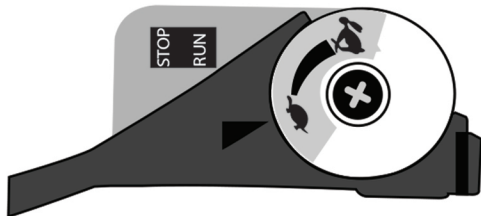

Maintain the engine running on idle for 3-5 minutes

5



Open the water valve and begin spraying



## TECHNICAL SPECIFICATIONS

<b>Model</b>	CPS435
<b>Engine</b>	TE26CC
<b>Engine Type</b>	2 Cycle Air Cooled Engine
<b>Fuel Type</b>	50:1 Pre Mix
<b>Displacement</b>	26cc
<b>Ignition</b>	Electronic Ignition
<b>Starting System</b>	Recoil Starter
<b>Pump</b>	Diaphragm Pump
<b>Pump System</b>	Brass and Copper Housing/Fittings, Ceramic Seals
<b>PSI</b>	Adjustable from 50 - 450 Max PSI
<b>Tank Capacity</b>	5.3 Gallons (20L)
<b>Dry Weight</b>	22 lbs (9.8 kg)
<b>Full Tank Weight</b>	65 lbs (29.5 kg)
<b>Dimensions</b>	24" X 20" X 15"

## MAIN APPLICATIONS

Spraying Herbicides, Pesticides, Fungicides, and other Water-based solutions.

Built for professional pest control companies, landscapers, and do-it-yourselfers alike, the Cardinal CPS435 Backpack Sprayer features a powerful 1.8HP (26cc) lightweight, 2 Stroke engine – making it the perfect backpack sprayer for pesticide, herbicide, fungicide applications around homes, farms, ranches, and more.

## Features

- Spray Up to 30ft
- Adjustable Pressure from 50-450 PSI
- Lightweight 26cc, 2 Stroke Engine
- Spray one acre in 15 minutes
- Large 5.3 Gallon (20 Liter) Chemical Tank
- 1 Year Engine Warranty

## Intended Uses

- Commercial Landscapers
- Pest Control Companies
- Agricultural Pest Control
- Greenhouses
- Commercial & Residential Areas
- Farms, Barns, Dairies, Kennels
- Around Livestock
- Ornamental Plants
- Orchards & Vegetable Gardens
- Parks & Recreation Areas
- Golf Courses

## Target Pests

- Mosquitoes & Ticks
- Ants & Cockroaches
- Caterpillars & Worms
- Fleas
- Biting Flies & Horse Flies
- Scorpions & Wasps
- Spider Mites
- Thrips
- Stink Bugs & Beetles

# SAFE SPRAYING AND PROTECTIVE GEAR

## Safe Spraying Operation

Using the accelerator (on the operator's left side) control the speed of the engine. This will adjust the distance and spread of the spraying.

**NOTE: Operation during weather with little wind is recommended. For example, in the early morning or in the late afternoon. This can reduce evaporation and/or drift of chemicals and improve spraying efficiency.**

1. Follow the chemical manufacturer's instructions best preparation and application practices.
  - a. Consider pressure distances, barriers you may encounter, and if you run out of chemical solution - marking where you left off.
2. Determine the areas you want to spray and mix the proper chemical, pesticide, and/or herbicide to most effectively and efficiently spray the desired area.
3. Operator should face his/her back to the wind.
4. If operator's mouth or eyes are spattered with chemicals, wash them immediately with clean water and go to a doctor immediately.
5. If the operator experiences headaches or dizziness, stop working at once.
6. For the operator's safety, spraying must be carried out strictly according to the instruction of the solutions requirements.
7. Choose the correct accessory:
  - a. For tall trees, buildings, and out of reach areas, the Cardinal Foundation Gun is a good choice.
  - b. For Quick Maximum Coverage a Dual Wand setup with 3 nozzles is ideal.
  - c. For precise spraying consider the Tomahawk Dual Nozzle or Conical Gun.

**Choosing the right spraying accessory will make the job much easier.**

## Protective Gear

Read the Operation Manual carefully and wear the proper protective gear:

- Wear a flanged cap
- Wear dirt/fog-proof goggles
- Wear a respirator
- Wear proper hearing protection
- Wear a coat guard
- Wear long sleeves
- Wear pants
- Wear protective gloves
- Wear boots

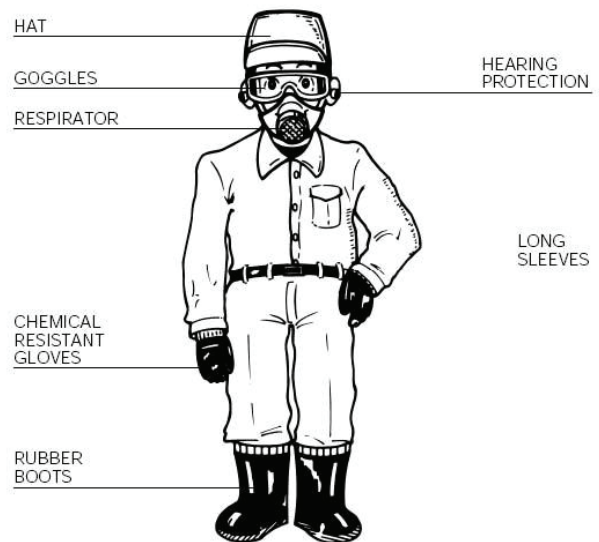

## STARTING THE ENGINE

*When starting the engine make sure the engine is fueled and the solution tank is prepped for spraying.*

1. Move the choke to the closed position.
2. Push the fuel-injecting pump (to the left of the recoil starter) continuously until fuel is visibly passing through the fuel lines. 3-5 pumps should be sufficient.
3. Pull the recoil starter until the engine fires.
4. After the engine starts, slowly move the choke to the closed position.
5. Let the engine idle for several minutes and then begin spraying.
6. Open your water valve to start flow of liquid pesticide and begin spraying.

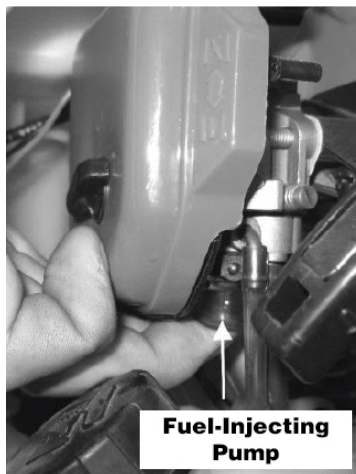

### ***Pressure Adjustment***

***To increase pressure, twist the pressure knob clockwise (to the right) to decrease pressure twist the pressure knob counterclockwise (to the left).***

## STOPPING THE ENGINE

1. Stop spraying to interrupt the flow of liquid pesticide.
2. Move the Throttle Lever up to the idle position.
3. Press the Stop Switch located on the side of the engine.
  - a. The Throttle Lever and Stop Switch will be on the operator's left side when wearing the backpack sprayer.
4. Move the choke to the closed position.
5. Remember: Do not run the motor without liquid in the tank. as this can ruin the bearings in the pump which are water cooled.

***Important tip: Remember to rinse the tank with 5 gallons of water to remove any chemicals that may crystalize in the pump, hose, and attachments.***

# TROUBLESHOOTING

## Engine Troubleshooting Guide

Problem	Cause	Remedy
Fails to start	Fail to push the fuel-injecting pump	Push continuously
	Water mixed with fuel	Replace the fuel
	Deterioration or carbon deposit of spark plug	Replace the plug
	Bad contact between spark plug and lead wire	Check spark plug
It starts but cannot run at high speed	The choke is not on the full open position	Open to full position
	Wrong ratio of fuel	Replace
	Water in fuel	Replace the fuel
It runs but does not work efficiently	The air filter is dirty	Check and clean
	Outlet of cylinder and muffler are dirty	Remove the dirt
	Piston, piston ring, cylinder have been worn	Replace
Stops while running	Fuel is out	Add fuel
	The lead wire of plug is loose	Check and replace
	Plug covered with carbon	Replace the plug
	The filter is clogged	Clean
	Water in fuel	Replace fuel
	The air hole in the tank lid is clogged	Clean

## Spraying Troubleshooting Guide

Problem	Cause	Remedy
Liquid does not spray out	Inlet valve and outlet valve blocked	Replace or clean
	Washer is damaged	Replace
	6004Z bearing is damaged	Replace
	Piston is damaged	Replace
Low or no spraying pressure	Not enough pressure	Regulate
	Not enough elastic force on regulating spring	Replace
	Corrosion resistant steel ball worn	Replace
	Pressure regulating valve seat worn	Replace
Pressure is fine but spraying is low	Piston is worn	Replace
	Piston running distance is not enough	Replace
	Inlet valve and outlet valve are worn	Replace
	Spraying parts are clogged	Clean
Spraying mist is low	The holes of spraying sheet are worn	Replace
	Spraying parts are clogged	Clean

## CPS435: Pump Quick Fix Guide



**1** Start the engine and keep it in idle.



**2** Using a 10mm socket wrench, loosen the 4 bolts on the right & left sides of the pump.



**3** Loosen the left screw on the left side.



**4** Loosen the right screw on the left side.



**5** Loosen the left screw on the right side.



**6** Loosen the right screw on the right side. Look for water to begin flowing through the tubes.

## SPRAYER CLEANING AND STORAGE

### Sprayer Cleaning

Immediately after each use of your Cardinal Sprayer it is important to clean it properly. Fill the chemical tank of the sprayer with 5 gallons of clean water. Start the engine and proceed to spray the water into a waste receptacle. Routine cleaning will help to clean out the sprayer's pump, hoses, and spraying attachments – while reducing the chances of the system clogging.



**DO NOT use Xylene or any explosive chemical in the cleaning process. This backpack sprayer is meant for use with water-based or waterborne compounds only. Do not spray solvent-based or explosive liquids with this sprayer. Failure to comply may cause serious bodily harm or death.**

### Sprayer Storage

*For long-term storage of the sprayer, first perform all regular maintenance procedures and needed repairs.*

1. Empty the fuel tank in a fuel-safe receptacle.
2. Disconnect the fuel supply line from the carburetor and depress the primer bulb until fuel stops discharging from the fuel-return line.
3. Start the engine and allow it to run until it stops.
4. Pull the starter cord a few times to remove any excess fuel from the engine.
5. Remove the spark plug and insert a small amount of oil into the cylinder.
6. Slowly pull the starter cord and bring the piston to a position closest to the spark plug hole.
7. Re-install the spark plug.
8. Apply a thin coating of oil to all the metal surfaces and store the sprayer in a dry place.

## PROPOSITION 65

 **WARNING:** 

The engine exhaust from this product contains chemicals known to the State of California to cause cancer, birth defects or other reproductive harm.

## EPA WARRANTY

### CALIFORNIA AND FEDERAL EMISSION CONTROL WARRANTY STATEMENT YOUR WARRANTY RIGHTS AND OBLIGATIONS

The California Air Resources Board, the United States Environmental Protection Agency and Tomahawk Power, LLC are pleased to explain the emissions control system warranty on your 2018-2019 small engine/equipment (SORE). In the United States and California, new small engine/equipment must be designed, built and equipped to meet the State's stringent anti-smog standards. Tomahawk Power, LLC must warrant the emissions control system on your small engine/equipment for the periods of time listed below provided there has been no abuse, neglect or improper maintenance of your small engine/equipment. Your emission control system may include parts such as the carburetor, fuel-injection system, the ignition system, catalytic convertor, fuel tanks, fuel lines, fuel caps, valves, canisters, filters, vapor hoses, belts, clamps, connectors, and other associated emission related components. For engines less than or equal to 80 cc, only the fuel tank is subject to the evaporative emission control warranty requirements of this section.  
(California only)

Where a warrantable condition exists, Tomahawk Power, LLC will repair your small off-road engine/equipment at no cost to you including diagnosis, parts and labor.

### MANUFACTURER'S WARRANTY COVERAGE:

The emissions control system is warranted for two years. If any emissions-related part on your small engine/equipment is defective, the part will be repaired or replaced by Tomahawk Power, LLC.

### OWNER'S WARRANTY RESPONSIBILITIES:

As the small engine/equipment owner, you are responsible for the performance of the required maintenance listed in your owner's manual. Tomahawk Power, LLC recommends that you retain all receipts covering maintenance on your small engine/ equipment, but Tomahawk Power, LLC cannot deny warranty solely for the lack of receipts or for your failure to ensure the performance of all scheduled maintenance.



As the small engine/equipment owner, you should however be aware that Tomahawk Power, LLC may deny your warranty coverage if your small engine/equipment or a part has failed due to abuse, neglect, improper maintenance or unapproved modifications. You are responsible for presenting your small engine/equipment to distribution center or service center authorized by Tomahawk Power, LLC as soon as the problem exists. The warranty repairs should be completed in a reasonable amount of time, not to exceed 30 days.

If you have any questions regarding your warranty rights and responsibilities, you should contact Tomahawk Power, LLC customer service representative at 1-866-577-4476 or Email: sales@tomahawk-power.com.

#### DEFECTS WARRANTY REQUIREMENTS

(a)The warranty period begins on the date the small engine/equipment is delivered to an ultimate purchaser.

(b)General Emissions Warranty Coverage. Tomahawk Power, LLC warrants to the ultimate purchaser and each subsequent owner that the engine/equipment is:

(1) Designed, built, and equipped so as to conform with all applicable regulations adopted by the Air Resources Board; and

(2) Free from defects in materials and workmanship that causes the failure of a warranted part for a period of two years.

(c)Subject to certain conditions and exclusions as stated below, the warranty on emissions related parts is as follows:

(1)Any warranted part that is not scheduled for replacement as required maintenance in your **Owner's Manual** is warranted for the warranty period stated above. If the part fails during the period of warranty coverage, the part will be repaired or replaced by Tomahawk Power, LLC according to Subsection (4) below. Any such part repaired or replaced under warranty will be warranted for the remainder of the period.

(2)Any warranted part that is scheduled only for regular inspection in your **Owner's Manual** is warranted for the warranty period stated above. Any such part repaired or replaced under warranty will be warranted for the remaining warranty period.

(3)Any warranted part that is scheduled for replacement as required maintenance in your **Owner's Manual** is warranted for the period of time before the first scheduled replacement date for that part. If the part fails before the first scheduled replacement, the part will be repaired or replaced by Tomahawk Power, LLC according to Subsection (4) below. Any such part repaired or replaced under warranty will be warranted for the remainder of the period prior to the first scheduled replacement point for the part.

(4)Repair or replacement of any warranted part under the warranty provisions herein must be performed at a warranty station at no charge to the owner.

(5)Notwithstanding the provisions herein, warranty services or repair will be provided at all of our distribution centers that are franchised to service the subject small engine/equipment.

(6)The small engine/equipment owner must not be charged for diagnostic labor that leads to the determination that a warranted part is in fact defective, provided that such diagnostic work is performed at a warranty station.

(7)Tomahawk Power, LLC is liable for damages to other small engine/equipment components proximately caused by a failure under warranty of any warranted part.

(8)Throughout the small engine/equipment warranty period stated above, Tomahawk Power, LLC will maintain a supply of warranted parts sufficient to meet the expected demand for such parts.

(9) Any replacement part may be used in the performance of any warranty maintenance or repairs and must be provided without charge to the owner. Such use will not reduce the warranty obligations of Tomahawk Power, LLC

(10) Add-on or modified parts that are not exempted by the Air Resources Board may not be used. The use of any non-exempted add-on or modified parts by the ultimate purchaser will be grounds for disallowing a warranty claim. Tomahawk Power, LLC will not be liable to warrant failures of warranted parts caused by the use of a non-exempted add-on or modified part.

(11) The manufacturer issuing the warranty shall provide any documents that describe that manufacturer's warranty procedures or policies within five working days of request by the Air Resources Board.

#### EMISSION WARRANTY PARTS LIST

The repair or replacement of any warranted part otherwise eligible for warranty coverage may be excluded from such warranty coverage if Tomahawk Power, LLC demonstrates that the small engine/equipment has been abused, neglected, or improperly maintained and that such abuse, neglect, or improper maintenance was the direct cause of the need for repair or replacement of the part. That notwithstanding, any adjustment of a component that has a factory installed, and properly operating, adjustment limiting device is still eligible for warranty coverage. The following emissions warranty parts for each engine family list is covered.

For engine families greater than 80cc:

(1) Fuel Metering System:

(a) Gasoline carburetor assembly and its internal components

(b) Carburetor gaskets

(c) Fuel tank

(d) Fuel Line

(e) Fuel Line Fittings

(f) Clamps

(g) Pressure regulator (if equipped)

(h) Mixer assembly and its internal components (if equipped)

(2) Air Induction System including:

(a) Intake pipe/manifold

(b) Air cleaner

(3) Ignition System including:

(a) Spark plug

(b) Ignition coil

(4) Catalytic Muffler Assembly including:

(a) Muffler gasket

(b) Exhaust manifold

(c) Catalytic converter

(5) Crankcase Breather Assembly including:

(a) Breather connection tube.

(6) Fuel tank evaporative emissions control system including:

(a) Purge Valves

(b) Carbon Canister

(c) Canister Mounting Brackets

(d) Fuel Cap

(e) Fuel Tank

(7) Miscellaneous items Used in Above Systems including:

(a) Switches

(b) Hoses, belts, connectors, and assemblies.

(8) Air injection system

(a) Pulse valve

For engine families less than or equal to 80cc:

(1) Fuel Metering System:

(a) Gasoline carburetor assembly and its internal components

(b) Fuel filter (if so equipped)

(c) Carburetor gaskets

(d) Fuel pump (if so equipped)

(2) Air Induction System including:

(a) Intake pipe/manifold

(b) Air cleaner

(3) Ignition System including:

(a) Spark plug

(b) Ignition module/coil

(4) Catalytic Muffler Assembly (if so equipped) including:

(a) Muffler gasket

(b) Exhaust manifold

(5) Crankcase Breather Assembly including:

(a) Breather connection tube.

(6) Miscellaneous items Used in Above Systems including:

(a) Switches

(b) Hoses, belts, connectors, and assemblies.

(7) Fuel tank evaporative emissions control system including:

(a) Fuel Tank

The warranty is provided in accordance with the "California AND FEDERAL Emission Control Warranty Statement".

## **TOMAHAWK WARRANTY LIMITED WARRANTY STATEMENT**

The Cardinal CPS435 Backpack Sprayer, a Tomahawk Power, LLC brand, is warranted to the original purchaser to be free from defects in material and workmanship from the date of purchase for the time periods listed as follows:

1 Year for Commercial Use

Any part of the CPS435 Concrete Sprayer found to be defective within the applicable warranty period shall, at Tomahawk Power's option, be repaired or replaced without charge. Warranty consideration is obtained by delivering any Tomahawk Power product to an Authorized Tomahawk Power Dealer / Service Center within the applicable warranty period. Or calling Tomahawk Power.

This warranty does not cover the following:

1. Maintenance items (excluding defects in materials and workmanship) including hoses, spark plugs, starter rope, air and fuel filters, clutch shoes, vibration isolators, throttle cables and all cutting attachments, etc.
2. Extra expenses including shipping and handling, travel, payment for lost time or pay and for any inconvenience and storage.
3. Alterations or modifications including aftermarket parts not authorized by Tomahawk Power, LLC.
4. Wear, accident, abuse, neglect, misuse, negligence, improper fuels, lubricants, fuel mixtures (when applicable), or failure to operate or maintain the product in accordance with instructions approved by Tomahawk. Repair or replacement as provided under this warranty is the exclusive remedy of the consumer. Tomahawk shall not be liable for any incidental or consequential damages for breach of any express or implied warranty on these products except to the extent prohibited by applicable law. Any implied warranty of merchantability or fitness for a particular purpose on these products is limited in duration to the warranty period as defined in the limited warranty statement. Tomahawk reserves the rights to change or improve the design of the product without notice and does not assume obligation to update previously manufactured products. This warranty provides you with specific legal rights, which may vary from state to state. It is the Owner's and Dealer's responsibility to make sure the Warranty Registration is properly filled out online at [www.tomahawk-power.com](http://www.tomahawk-power.com)

# CARDINAL

CPS435  
BACKPACK SPRAYER

Parts Manual

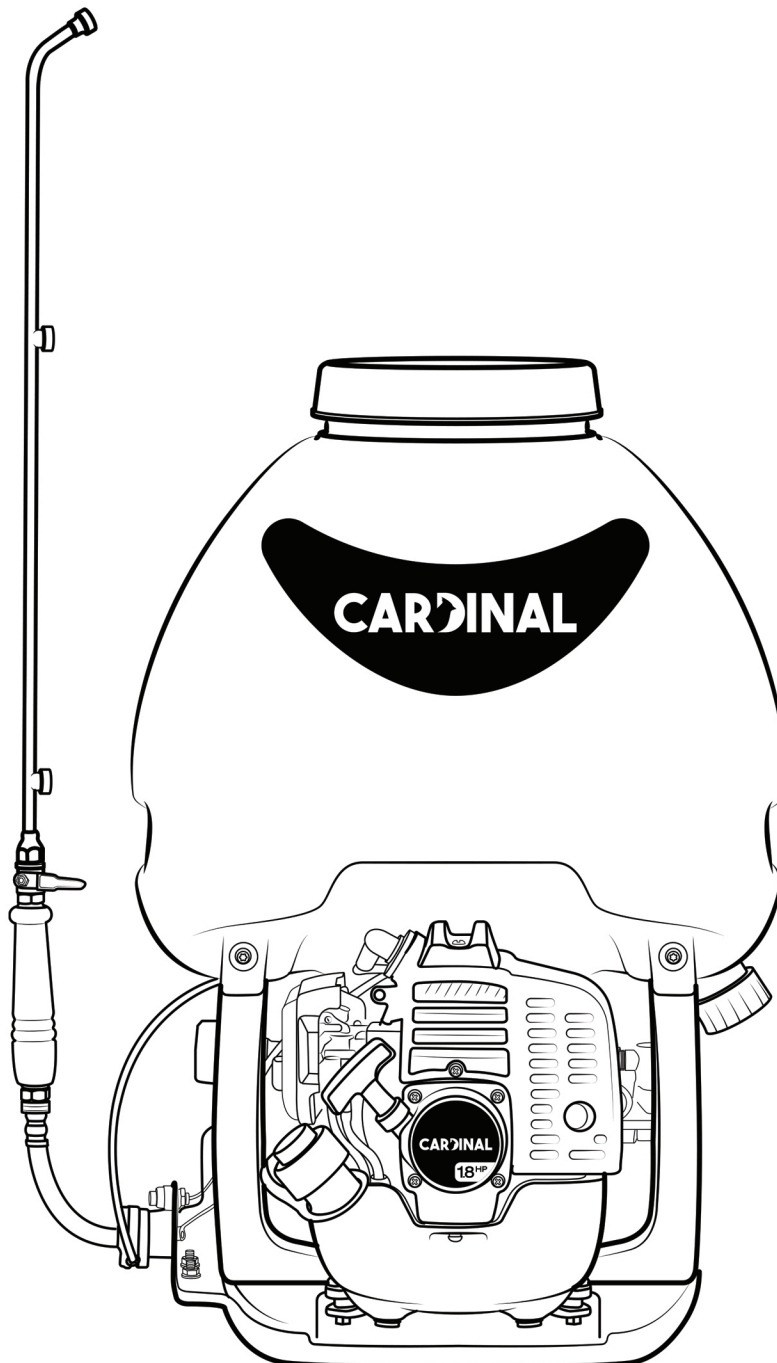

**BACKPACK SPRAYER  
TANK AND FRAME DIAGRAM  
SKU: CPS435**

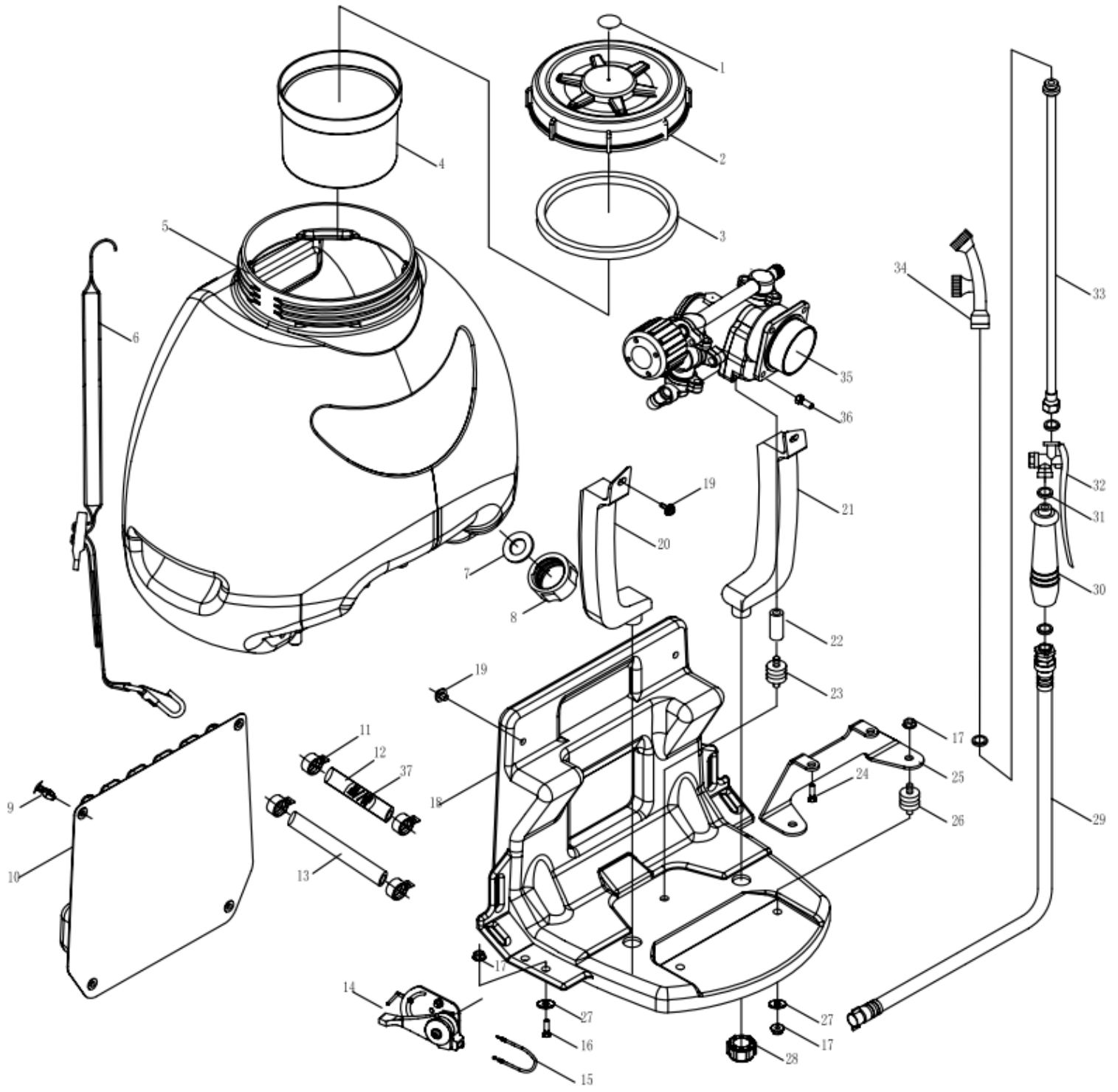

**BACKPACK SPRAYER TANK  
AND FRAME DIAGRAM  
SKU: CPS435**

NO.	Part NO.	Part Name	Qty.
1	3WZ-6D.1-5	LID	1
2	3WZ-6D.1-1	LID	1
3	3WZ-6D.1-4	SEALING WASHER	1
4	3WZ-6D.1.2	FILTER ASSM	1
5	3WZ-6F.1.1	CHEMICAL TANK	1
6	6MF-18-44-YT	BANDS ASSM	2
7	3WF-3A.1-2	SEALING WASHER	1
8	3WZ-6.5-1	LID	1
9	3WF-14-13	PLASTIC CLICK	4
10	3WZ-9.1	BACK DACK ASSM	1
11	QC/T621 Q673B15	CLIP	4
12	GB13527.1LS-10×2.5×140	TUBE	1
13	GB13527.1LS-10×2.5×340	TUBE	1
14	3WZ-9.5	SWITH	1
15	3WZ-4C.3	FREL THROTTLE	1
16	GB/T29.2+GB/T96	SCREW ASSY M6×20	2
17	GB/T6177.1 M6	NUT M6	7
18	3WZ-6-4	FRAME	1
19	GB/T823+GB/T96	SCREW M6×12	4
20	3WZ-6-9	LEFT SUPPORT	1
21	3WZ-6-5	RIGHT SUPPORT	1
22	6MSW-5-7B-1	SUPPORT MOUNT	1
23	3WZ-7B.2B	RUBBER MOUNT	1
24	GB70+GB93+GB97	SCREW ASSEM 5×20	2
25	3WZ-6F-1C	CONNECT PLATE	1
26	3WZ-6.1	RUBBER MOUNT	2
27	GB/T 96	WASHER 6	5
28	3WZ-6-2	PLASTIC NUT	2
29	3WZ-6.6	RUBBER TUBE ASSY	1
30	3WZ-4.11	HANDLE	1
31	3WZ-4-10	SEAL RING	4
32	3WZ-7E.1-2	VALVE	1
33	3WZ-4.13	STAIGHT SPRAYING TUBE	1
34	3WZ-6B-HYUNDAI-8	NOZZLE	1
35	3WZ-7B.5A	PISTON PUMP	1
36	GB/T 9074.13	SCREW M6×16	4
37	3WZ-4.7.4-2A	SPRING	1

**BACKPACK SPRAYER  
PUMP DIAGRAM  
SKU: CPS435**

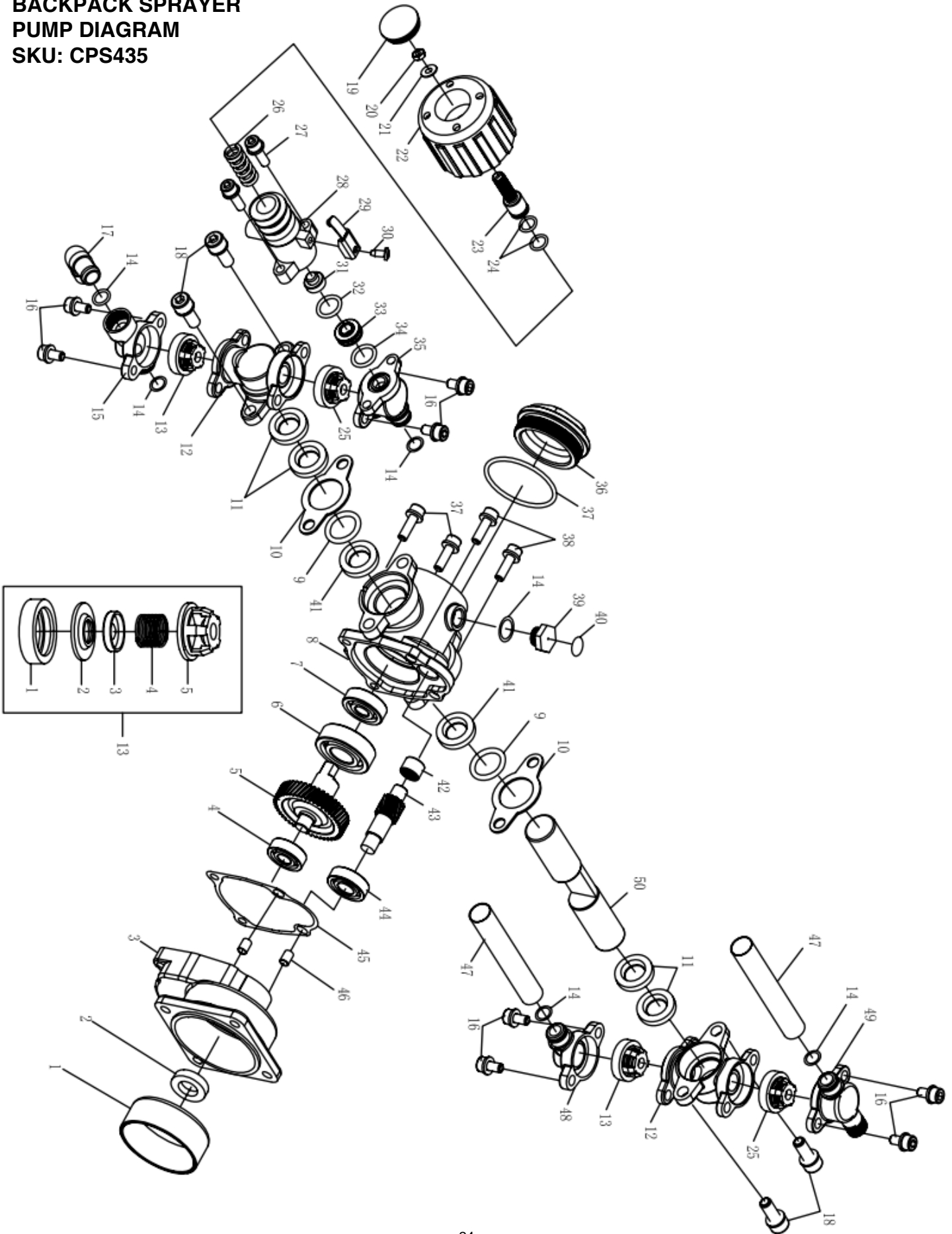



**BACKPACK SPRAYER  
PUMP DIAGRAM  
SKU: CPS435**

NO.	Part NO.	Part Name	Qty.
1	3WZ-7B.5-1	CLUTCH DRUM COVER	1
2	1E36F.2	SEAL	1
3	3WZ-7B.5.1-1B	CONNECTING BASE	1
4	GB/T276	BEARING 6000/P6	1
5	3WZ-7B.5.1-3	WHEEL	1
6	GB/T276	BEARING 6204 P6	1
7	GB/T276	BEARING 6301 P5	1
8	3WZ-7B.5.1-2A	NOUMENON	1
9	GB/T3452.1	O-RING 21.2×1.8	2
10	3WZ-7B.5-6	BAFFLE	2
11	3WZ-7B.5.3-4	WATER SEAL	4
12	3WZ-7B.5.3-3	CYLINDER STATOT	2
13	3WZ-7B.5.2A	CHECK VALVE	2
14	GB/T6659	O-RING 10×2	6
15	3WZ-7B.5.4-1	WATER CHAMBER B	1
16	GB70.1+GB93	SCREW ASSM M6X12	8
17	3WZ-7B.5-5A	WATER INLET	1
18	GB70.1+GB93	SCREW ASSM M8X20	4
19	3WZ-7B.5.5-8	HANDLE CAP	1
20	GB6172	NUT M8	1
21	GB97.1	WASHER 8	1
22	3WZ-7B.5.5-1	HANDLE	1
23	3WZ-7B.5.5-3A	REGULATING SCREW	1
24	GB/T6659	O-RING 10×1.8	2
25	3WZ-7B.5.2	CHECK VALVE	2
26	3WZ-7B.5.5-5	SPRING	1
27	GB70.1	SCREW ASSM M6X16	2
28	3WZ-7B.5.5-2	VALVE	1
29	3WZ-7B.5.5.1A	BATTERY BOARD	1
30	GB845ST4.2X10	SCREW ASSEM	1
31	3WZ-7B.5.5-4	SPRING SEAT 1	1
32	GB3452.1	O-RING 12.5×2.65	1
33	3WZ-7B.5.5-7	VALVE SEAT	1
34	GB3452.1	O-RING 11.8×1.8	1
35	3WZ-7B.5.3-2	DISCHARGE METAL A	1
36	3WZ-10.1-1	BOX BACK COVER	1
37	GB/T3452.1	O-RING 46.2×2.65	1

**BACKPACK SPRAYER  
PUMP DIAGRAM  
SKU: CPS435**

38	GB70.1+GB93	SCREW ASSM M6X20	4
39	3WZ-7B.5-2A	BOLT	1
40	3WZ-7B.5-7	PASTER	1
41	3WZ-7B.5.1-7	OIL SEAL	2
42	GB/T290 HK1010	BEARING	1
43	3WZ-7B.5.1-3	GEAR SHAFT	1
44	GB/T276	BEARING 6001 P5	1
45	3WZ-10.1.1-5A	SEALING WASHER	1
46	6MF-30.1-14	PIN	2
47	3WZ-10.1-2	TUBE	2
48	3WZ-7B.5.3-1	WATER CHAMBER A	1
49	3WZ-7B.5.4-2	DISCHARGE METAL B	1
50	3WZ-10.1.1-4	PLUNGER	1
13-1	3WZ-7B.5.2-1	BALL SEAT	1
13-2	3WZ-7B.5.2-2	VALVE DISK	1
13-3	3WZ-7.5.2-3	VALVE BLOCK	1
13-4	3WZ-7B.5.2-4A	VALVE SPRING	1
13-5	3WZ-7B.5.2-5	VALVE BONNET	1



**BACKPACK SPRAYER  
ENGINE DIAGRAM  
SKU: CPS435**

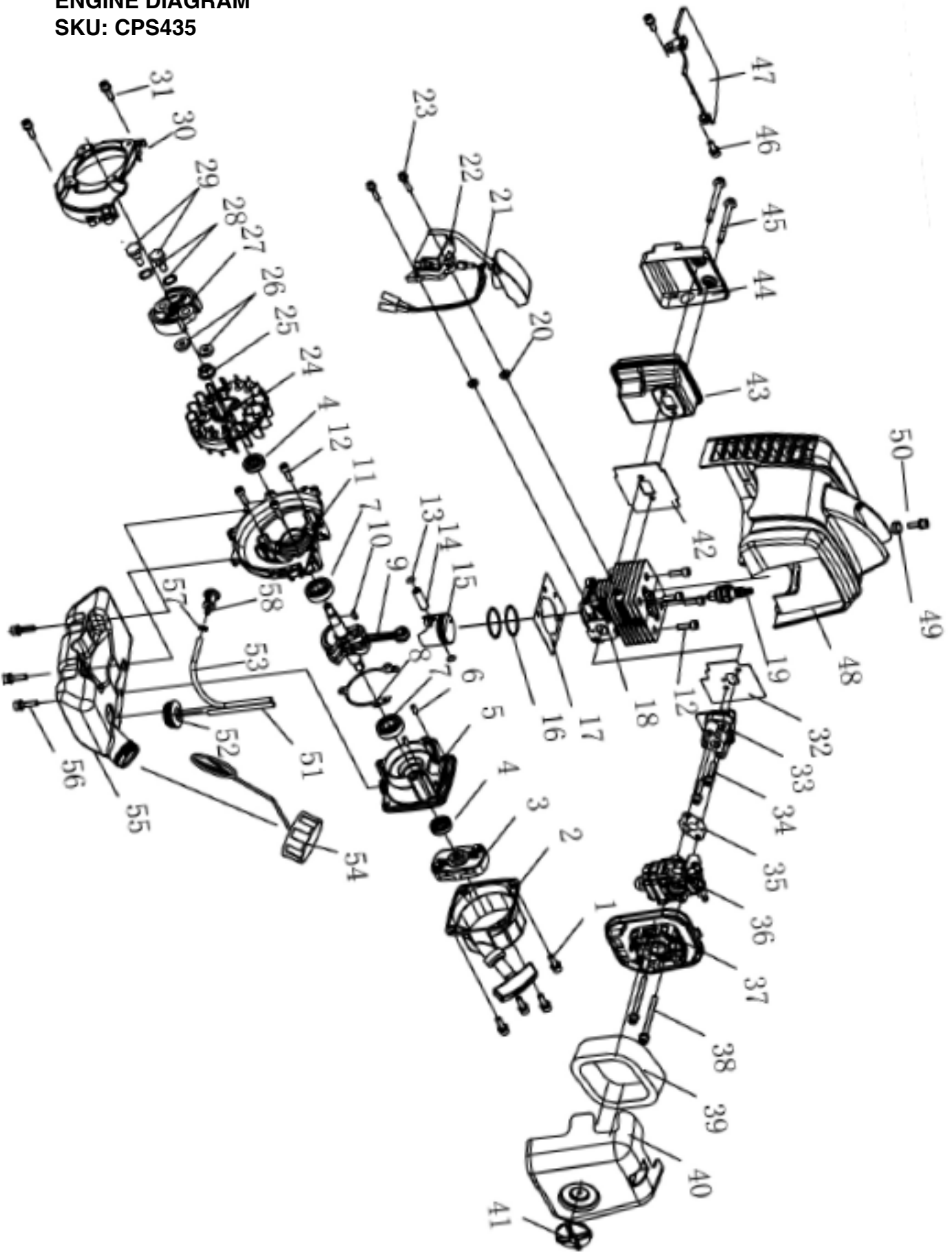

**BACKPACK SPRAYER  
ENGINE DIAGRAM  
SKU: CPS435**

NO.	Part NO.	Part Name	Qty.
1	GB70.1+GB93+GB97	SCREW M5×16	4
2	P23.10A	STARTER	1
3	P23.9A	GUIDE COVER ASS'Y	1
4	1E36F.2	OIL SEAL	2
5	P23.11-2	CRANK CASE R	1
6	GB/T119.1	PIN 4×H8×8	2
7	GB/T276	BEARING 6001/P53	2
8	P23.11-3	GASKET CRANK CASE	1
9	P23.6A.1	CRANK SHAFT ASSY	1
10	1E40FP-3Z.3-1	KEY	1
11	P23.11-1	CRANK CASE F	1
12	GB/T70.1	SCREW M5×16	7
13	1E34F.6-2	RING SNAP	2
14	1E31F.4-2	PISTON PIN	1
15	P23.6A-1	PISTON	1
16	P23.6-2	RING PISTON	2
17	P23-2	GASKET CYLINDER	1
18	P23-1	CYLINDER	1
19	CMR6A	SPARK PLUG	1
20	P40-5	SPACER IG COIL	2
21	1E40F-5.3.1	WIRE LEAD ASSY	1
22	HP23.2.1-SZ.2	IG COIL	1
23	GB70.1+GB93+GB97	SCREW M4×20	2
24	HP23.2.1-SZ.1	ROTOR MAGNET	1
25	GB/T6177	NUT M8	1
26	1E34F-11	WAVE WASHER	2
27	1E34F.10	CLUTCH ASSY	1
28	1E34F-13	WASHER	2
29	1E34F-12	CLUTCH BOLT	2
30	HP23-1	FAN COVER	1
31	GB70.1+GB93+GB97	SCREW M5×18	3
32	P23-7	GASKET INSULATOR	1
33	P23.3	INSULATOR	1
34	GB70.1+GB93+GB97	SCREW M5×25	2
35	1E36F-2A-1	GASKET CARBURETOR	1
36	1E34F-2E.1A	CARBURETOR	1
37	1E34F.1.1	CLEANER BASE ASSY	1

**BACKPACK SPRAYER  
ENGINE DIAGRAM  
SKU: CPS435**

NO.	Part NO.	Part Name	Qty.
38	GB70.1+GB97.1	SCREW M5×60	2
39	1E34F.1-1	AIR FILTER ELEMENT	1
40	HP23.1-1	COVER CLEANER	1
41	1E34FG.1.1	KNOB COVER	1
42	1E34F-3	GASKET MUFFLER	1
43	1E34F-2E.2	MUFFLER	1
44	HP23-5A	COVER	1
45	HP23-8	SCREW M5×55-10.9	2
46	GB70.1+GB93+GB97	SCREW M5×14	2
47	HP23-2	CLAPBOARD	1
48	HP23.3	TOP COVER	1
49	1E33F-4	SPACER IG COIL	1
50	GB70.1+GB93+GB97	SCREW M5×18	1
51	1E44F-E.5.1-2-EPA	FUEL PIPE $\phi 5 \times \phi 2.5 \times 100$	1
52	1E36FF.8.1-1	PLUG	1
53	1E44F-E.5.1-1-EPA	FUEL PIPE $\phi 5.5 \times \phi 3 \times 165$	1
54	1E32FL.6.2B	TANK CAP ASSY	1
55	HP23.6.1	FUEL TANK	1
56	GB70.1+GB93+GB97	SCREW M5×16	3
57	P23.12-1	SNAP RINGS	1
58	P40.12.2-3A	FILTER	1



# CARDINAL

CPS435  
FUMIGADORA DE MOCHILA

Manual de Operación

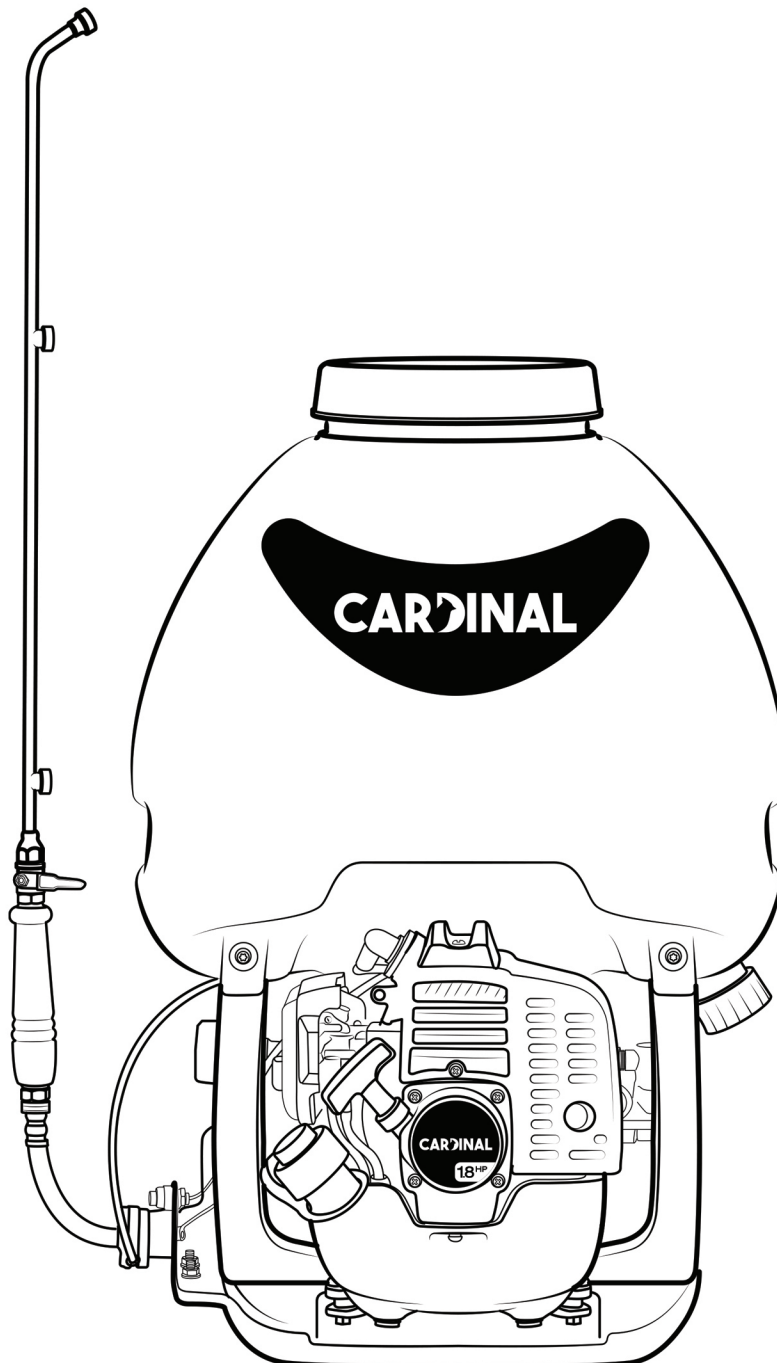



# PRÓLOGO

<b>PRÓLOGO</b>	<b>2</b>
<b>MANUAL DE OPERACIÓN (MANUAL DE INGLÉS)</b>	<b>4-31</b>
<b>GARANTÍA DE EPA</b>	<b>16</b>
<b>GARANTÍA DE TOMAHAWK</b>	<b>20</b>
<b>MANUAL DE OPERACIÓN (MANUAL DE ESPAÑOL)</b>	<b>32</b>
<b>GUÍA PARA INSTALACIÓN DE PUNTA DOBLE</b>	<b>34</b>
<b>PRECAUCIONES PARA EL OPERADOR</b>	<b>35</b>
Advertencias sobre el equipo	35
Manejo de Químicos	35
<b>ADVERTENCIAS</b>	<b>36</b>
<b>OPERACIÓN SEGURA</b>	<b>37</b>
<b>GUÍA RÁPIDA PARA LA OPERACIÓN</b>	<b>38</b>
<b>ESPECIFICACIONES TÉCNICAS</b>	<b>39</b>
<b>APLICACIONES PRINCIPALES</b>	<b>39</b>
Características	39
Usos Previstos	39
Tipo de Plagas	39
<b>FUMIGACIÓN SEGURA Y EQUIPO DE PROTECCIÓN</b>	<b>40</b>
<b>ENCENDIDO DEL MOTOR</b>	<b>41</b>
<b>APAGUE EL MOTOR</b>	<b>41</b>
<b>SOLUCIÓN DE PROBLEMAS</b>	<b>42</b>
Solución de Problemas para el Motor	42
Solución de Problemas de Rociar/Pulverizar	43
<b>GUÍA RÁPIDA PARA REPARACIÓN DE LA BOMBA</b>	<b>44</b>
<b>LIMPIEZA DE LA FUMIGADORA Y ALMACENAJE</b>	<b>45</b>
<b>PROPUESTA 65</b>	<b>45</b>
<b>LISTA DE REPUESTOS</b>	<b>46</b>
<b>CATÁLOGO TOMAHAWK</b>	<b>58</b>



**1** Saque todas las partes de la caja.  
(No ocupará todas las piezas para el ensamblado)

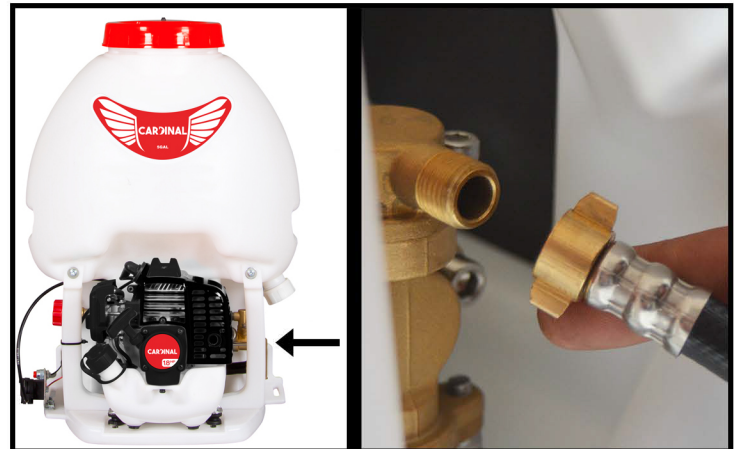

**2** Adjunte 1 manguera directamente en la bomba de la fumigadora.



**3** Fije el accesorio de la fumigadora a la parte en forma de válvula de la manguera.



**4** Para instalar el tirante de la mochila, páselo por debajo de la barra de metal.



**5** Pase el tirante por le hebilla y apriete.  
Repita la misma operación con el otro tirante.



**6** Su fumigadora de mochila está lista para utilizarse.

\* Este manual puede ser utilizado para Nebulizador y los accesorios de la marca Cardinal.

## **PRECAUCIONES PARA EL OPERADOR**

1. Este producto emite monóxido de carbono, la cual es una toxina invisible e inodora. No utilice este producto dentro de un lugar cerrado.
2. Siempre asegure de apagar el motor antes de agregar gasolina al tanque.
3. Para evitar electrocutarse, no toque la tapadera de la bujía, o el cableado del motor mientras este encendido.
4. No toque la superficie del mofle y el cilindro mientras el motor esté encendido. Es extremadamente caliente.
5. No tire pesticidas o químicos cuando este llenando o descargando el tanque.
6. Mantenga su área de trabajo libre de personas, niños, y mascotas mientras esté operando la fumigadora.

### **Advertencias sobre el equipo**

1. El motor de la fumigadora CPS435 solamente debe utilizar mezcla de aceite 50:1, y gasolina con un mínimo de 90 octanos. El aceite para el motor debe ser para equipos de dos tiempos.
  - a. Nota: 50:1 premezcla es ideal para este producto ya que contiene un estabilizador de combustible para asegurar larga vida del equipo. Puede encontrar 50:1 premezcla en cualquier tienda de autoservicio y/o ferretería.
2. Después de encender el motor, mantenga el acelerador a una velocidad baja por varios minutos.
3. Gasolina es un combustible extremadamente inflamable. Cuando esté operando el equipo, manténgase alejado de cualquier llama. NO FUME mientras esté operando el equipo.
4. No fumigue en dirección hacia otras personas.
5. Comprenda la operación del equipo y cómo apagarlo rápido en caso de una emergencia.

### **Manejo de Químicos**

1. Utilice protección para los oídos.
2. Utilice protección para los ojos.
3. Utilice un respirador para para proteger su boca y cara de cualquier químico o polvos.
4. Utilice zapatos que protejan sus pies.
5. Utilice pantalones y camisa de manga larga para evitar contacto con los químicos.
6. Utilice guantes que protejan sus manos y evite el contacto directo con químicos.
7. Después de operar el equipo, lave sus manos y ropa inmediatamente.

## ADVERTENCIAS



**Esta fumigadora de mochila debe utilizarse con solventes compuestos de agua. No pulverice o rocíe solventes o líquidos explosivos con esta fumigadora.**



No fumigue en dirección a otras personas, los químicos utilizados en la fumigadora pueden causar serios daños a personas y/o animales.



El escape tóxico puede ser inodoro e incoloro y puede contener hidrocarburos y bencol que pueden ser nocivos para la salud. Nunca opere el equipo en lugares cerrados o ubicaciones con poca ventilación.

Durante la operación del equipo, el mofle y la cubierta pueden estar extremadamente calientes. Evite el contacto durante e inmediatamente después de la operación. Siempre mantenga el área de escape libre de desechos inflamables. Permita que el motor y el mofle se enfríen antes de realizar cualquier mantenimiento al equipo. Después de uso, lávese las manos y su ropa.

Nota: los residuos del pesticida pueden manchar todo lo que usted toque.

Abra la cubierta del combustible con cautela, permita que cualquier presión que se haya contenido en el tanque se libere lentamente. Evite derrames de combustible.

Solo llene de combustible el equipo en lugares con bastante ventilación. Si llega a tener un derrame de combustible, limpie el equipo inmediatamente. Si el combustible llega a estar en sus prendas, cambie de prendas inmediatamente.



Revise posibles derrames. Para reducir daños serios o fatales, no utilice el equipo si hay posibles derrames en el equipo. Espérese a que el derrame haya sido reparado.



Después de agregar combustible, asegúrese de apretar la tapadera ajustadamente.

Esto reducirá el riesgo de vibraciones en la unidad causando que la tapadera se afloje y cause derrames.

## OPERACIÓN SEGURA DE LA FUMIGADORA

### Precauciones sobre el combustible

- El motor es certificado para operar con gasolina sin plomo y aceite de dos tiempos, con una mezcla de proporción al 50:1.
- Este motor requiere de una mezcla de gasolina de alta calidad y aceite de dos tiempos enfriados por aire.
- Utilice gasolina de grado medio sin plomo, mínimo 91 de octanaje, y no más de 10% de contenido de etanol.
- Mantenga el tanque de gasolina alejado de llamas o chispas. No fume cerca del tanque.
- Cuando agrega la mezcla de combustible al motor utilice un embudo especial para evitar derrames.
- Cuando el equipo esté encendido, no agregue más gasolina al tanque.
- Abra la tapadera del tanque de gasolina con cautela para permitir que la presión generada en el tanque, lentamente se libere. Evite derrames de gasolina.
- Una vez que la temporada de fumigación haya terminado, asegúrese de drenar todo el combustible del tanque de gas y utilice un estabilizador de combustible para mantener el carburador limpio.

**NOTA: La gasolina es un combustible extremadamente inflamable.** Mantenga alejado de flamas. No permita derrames de gasolina. No fume cerca del motor o de la gasolina. Siempre apague el motor antes de reabastecer el combustible. No realice el reabastecimiento de combustible mientras el motor este caliente, posibles derrames podrán ocasionar fuego.

# CARDINAL

## CPS435: Guía Rápida Para La Operación

1

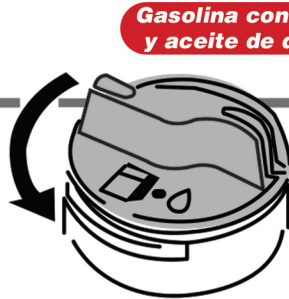

Llene el tanque de gasolina con el pre mezcla 50:1 de dos tiempos.

2



Llene el tanque químico con el pesticida lentamente.

3

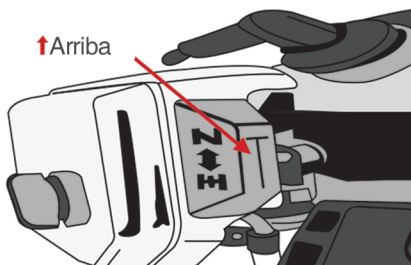

Posicione la manija en cerrado

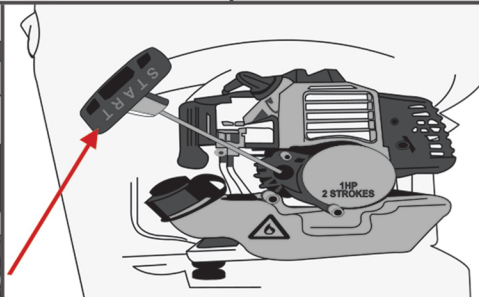

Jale el arrancador de retroceso de 1 a 3 veces, hasta que el motor encienda.

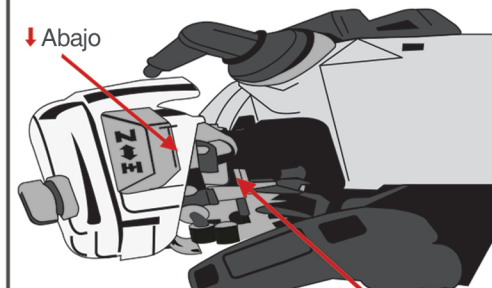

Mueva la manija de cerrado a la posición abierta

4

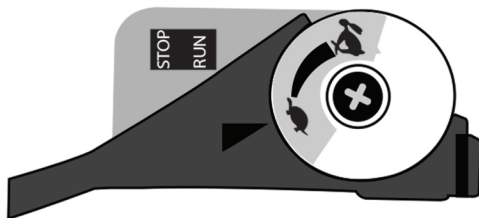

Mantenga el motor encendido en inactivo durante 3 – 5 minutos.

5



Abra la válvula de agua y empiece a rociar.

## ESPECIFICACIONES TÉCNICAS

<b>Modelo</b>	CPS435
<b>Motor</b>	TE26CC
<b>Tipo De Motor</b>	2 Tiempos Motor Enfriado por Aire
<b>Tipo De Combustible</b>	Mezcla 50:1
<b>Desplazamiento</b>	26cc
<b>Encendido</b>	Encendido Electrónico
<b>Sistema De Arranque</b>	Arrancado de Retroceso
<b>Bomba</b>	Bomba de Diafragma
<b>Material De Bomba</b>	Latón y Cobre, Sellos de Cerámica
<b>PSI</b>	Ajustable Desde 50 – 450 Max PSI
<b>Capacidad De Tanque</b>	5.3 Galones (20 Litros)
<b>Peso Seco</b>	22 Lbs (9.8 kg)
<b>Peso Con Tanque Lleno</b>	65 Lbs (29.8 kg)
<b>Dimensiones</b>	24" X 20" X 15"

### APLICACIONES PRINCIPALES

Fumigación de herbicidas, pesticidas, funguicidas, y otras soluciones basadas en agua.

Creado para compañías de fumigación profesional, jardinería profesional, e individuos que desean llevar a cabo la tarea de fumigación por si solos. La fumigadora de mochila Cardinal CPS435, incluye un poderoso y ligero motor con 1.8 hp (26cc) de dos tiempos, lo cual hace que sea la fumigadora de mochila perfecta para fumigar pesticidas, herbicidas, funguicidas en casas, granjas, ranchos y más.

#### Características:

- Fumiga hasta 30'
- Presión ajustable desde 50 – 450 PSI
- Motor de 26cc de dos tiempos
- Fumiga una acre en 15 minutos
- Tanque con una capacidad de 5.3 galones (20 litros)
- Garantía de motor por 1 años

#### Usos Previstos:

- Jardinería profesional
- Fumigadoras profesionales
- Control de plagas para agricultura
- Invernaderos
- Áreas comerciales y residenciales
- Granjas, ranchos
- Ganado
- Plantas decorativas
- Huertos y jardines vegetales
- Parques y centros recreativos
- Campos de golf

#### Tipo de Plagas:

- Mosquitos y garrapatas
- Hormigas y cucarachas
- Orugas y gusanos
- Pulgas
- Escorpiones y avispas
- Ácaros
- Trips
- Chinchas y escarabajos

# FUMIGACIÓN SEGURA Y EQUIPO DE PROTECCIÓN

## Operación Segura:

Utilizando el acelerador (de lado izquierdo del operador) controle la velocidad del motor. Esto ajustará la distancia y alcance del rociado.

**Nota: Se recomienda operar el equipo cuando el clima este presentando un poco de viento. Por ejemplo, temprano por la mañana o antes de anocheceer. Esto podrá reducir la evaporación de los químicos y mejorará la eficiencia del roció.**

1. Siga las instrucciones del producto insecticida para mejor resultados.
  - a. Tome en cuenta las distancias y la presión. Si se agota el insecticida en el tanque, asegúrese de saber hasta dónde fumigó.
2. Determine cuáles son las áreas que desea fumigar, y mezcle los químicos para su máxima eficiencia.
3. El operador de la fumigadora deberá darle la espalada al sentido del viento.
4. En caso de sus ojos o boca hagan contacto con los químicos, lávese inmediatamente con agua limpia y visite a su médico.
5. Si el operador llegara a sentir mareos o dolor de cabeza, deberá dejar de operar el equipo inmediatamente.
6. Por cuestiones de seguridad, el operador deberá seguir las instrucciones y recomendaciones de los químicos que desea utilizar.
7. Elija el accesorio adecuado.
  - a. Para árboles, edificios, y áreas fuera de alcance, el mejor accesorio es el Cardinal Foundation Gun (FG).
  - b. Para cobertura máxima se recomienda la doble lanza con tres boquillas.
  - c. Para fumigación precisa se recomienda la boquilla doble, el Cardinal conical gun (CG).

**Elegir el accesorio correcto hará que su trabajo sea más fácil.**

## Equipo de Protección:

Lea el manual de operación cuidadosamente, y use el equipo de protección adecuado:

- Utilice una gorra protectora
- Utilice gafas de protección
- Utilice un respirador
- Utilice protección auditiva
- Utilice protección para sus prendas de vestir
- Utilice manga larga
- Utilice pantalones
- Utilice guantes protectores
- Utilice botas de trabajo

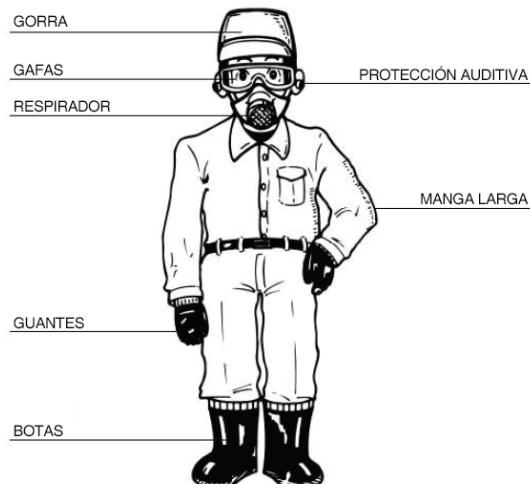



## ENCENDIDO DEL MOTOR

***Cuando encienda el motor asegúrese que el motor tiene la solución de combustible recomendada.***

1. Mueva la manija a la posición “cerrada” (closed)
2. Presione la bomba de inyección hacia el lado izquierdo del arrancador de retroceso, continuamente hasta que el combustible este visiblemente pasando por las líneas de combustible. Bombee de 3 a 5 veces.
3. Jale el arrancador de retroceso hasta que el motor sea encendido.
4. Después de que el motor haya sido encendido, lentamente mueva la manija a la posición “cerrada: (closed).
5. Permita que el motor corra inactivo por varios minutos antes de empezar a rociar.
6. Abra la válvula del agua para que empiece a fluir el pesticida, y empiece a rociar.

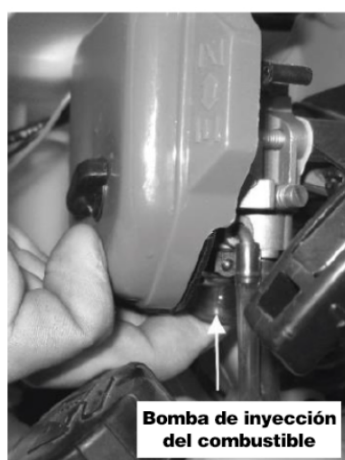

### ***Ajuste la presión***

***Para incrementar la presión, gire la perilla en sentido de las agujas del reloj (hacia la derecha). Para disminuir la presión gire la perilla en sentido opuesto (hacia la izquierda).***

## APAGUE EL MOTOR

1. Deje de fumigar para interrumpir el flujo del líquido pesticida
2. Mueva la palanca del acelerador a la posición inactiva
3. Presione el botón de “stop” localizado a un costado del motor
  - a. El acelerador y el botón de “stop” están ubicados de lado izquierdo del operador utilizando la mochila.
4. Mueva la manija a la posición “closed” (cerrado).
5. Recuerde: No encienda el motor sin líquido en el tanque, ya que esto puede arruinar los sellos en la bomba, los cuales son enfriados con agua.

***Recomendaciones importante: Recuerde enjuagar el tanque con 5 galones de agua para eliminar los químicos que puedan cristalizarse en la bomba, mangueras y accesorios.***

## Solución de Problemas para el Motor:

PROBLEMA	CAUSA	REMEDIO
<b><i>No enciende el motor</i></b>	No se presionó la bomba de inyección del combustible	Presione continuamente
	Se mezcló el agua con el combustible	Reemplace el combustible
	Deterioro de depósito de carbón de la bujía	Reemplace bujía
	Mala conexión entre bujía y alambre	Revisar bujía
<b><i>El motor enciende, pero no corre a toda velocidad</i></b>	La manija no está en la posición abierta	Mueva a posición abierta
	Proporción de mezcla incorrecta	Reemplace
	Agua en el combustible	Reemplace el combustible
<b><i>Empieza pero no funciona bien</i></b>	El filtro de aire está sucio	Revise y límpielo
	La salida del cilindro y el mofle están sucios	Elimine la mugre
	Desgaste del pistón, anillo de pistón y cilindro	Reemplace
<b><i>Se apaga mientras esta encendido</i></b>	El combustible se ha agotado	Agregue combustible
	El cable principal de la bujía esta flojo	Revise y reemplace
	La bujía está cubierta de carbón	Reemplace la bujía
	El filtro esta obstruido	Limpie
	Agua en el combustible	Reemplace el combustible
	El agujero de aire en el tanque esta obstruido	Limpie

## Solución de Problemas de Rociar/Pulverizar

PROBLEMA	CAUSA	REMEDIO
<b><i>No enciende el motor</i></b>	No se presionó la bomba de inyección del combustible	Presione continuamente
	Se mezcló el agua con el combustible	Reemplace el combustible
	Deterioro de depósito de carbón de la bujía	Reemplace bujía
	Mala conexión entre bujía y alambre	Revisar bujía
<b><i>El motor enciende, pero no corre a toda velocidad</i></b>	La manija no está en la posición abierta	Mueva a posición abierta
	Proporción de mezcla incorrecta	Reemplace
	Agua en el combustible	Reemplace el combustible
<b><i>Empieza pero no funciona bien</i></b>	El filtro de aire está sucio	Revise y límpielo
	La salida del cilindro y el mofle están sucios	Elimine la mugre
	Desgaste del pistón, anillo de pistón y cilindro	Reemplace
<b><i>Se apaga mientras esta encendido</i></b>	El combustible se ha agotado	Agregue combustible
	El cable principal de la bujía esta flojo	Revise y reemplace
	La bujía está cubierta de carbón	Reemplace la bujía
	El filtro esta obstruido	Limpie
	Agua en el combustible	Reemplace el combustible
	El agujero de aire en el tanque esta obstruido	Limpie

# CARDINAL

## CPS435: Guía Rápida para Reparación de la Bomba



**1** Encienda el motor y manténgalo inactivo.



**2** Utilizando una llave de tubo de 10mm, afloje los 4 tornillos de lado derecho e izquierdo.



**3** Afloje el tornillo de lado izquierdo.



**4** Afloje el tornillo de lado derecho.



**5** Afloje el tornillo izquierdo de lado derecho.



**6** Afloje el tornillo derecho de lado derecho. Revise si hay agua fluyendo por los tubos.

## LIMPIEZA DE LA FUMIGADORA Y ALMACENAJE

### Limpieza:

Después de cada uso de su fumigadora Cardinal CPS435 es importante que limpie la unidad debidamente. Llene el tanque químico con 5 galones de agua limpia. Encienda el motor y rocíe el agua en un tanque para residuos. La limpieza rutinaria le ayudara a limpiar la bomba, las mangueras y los accesorios, reduciendo así la obstrucción del sistema.

**NOTA: No use xileno o cualquier otro químico explosivo durante el proceso de limpieza. Esta fumigadora de mochila está diseñada para usar compuestos a base de agua únicamente. No rocié/pulverice solventes o líquidos explosivos con este equipo. El incumplimiento de este requisito puede causar daños severos o inclusive la muerte.**

### Almacenaje de la Fumigadora

*Para almacenaje de un periodo extendido, primero lleve a cabo la limpieza antes mencionada y realice las reparaciones necesarias.*

1. Vacíe el tanque de combustible en un recipiente seguro para combustible.
2. Desconecte el suministro de combustible del carburador y deprima la bombilla de cebado hasta que el combustible deje de descargar a la línea de regreso de combustible.
3. Encienda el motor y deje correr hasta que se detenga.
4. Jale el cordón de arranque varias veces para eliminar el exceso de combustible del motor.
5. Remueva la bujía e inserte una pequeña cantidad de aceite en el cilindro.
6. Lentamente jale el cordón de arranque y acerque el pistón lo más cercano posible al agujero del tapón.
7. Re-instale la bujía.
8. Aplique una delgada capa de aceite a todas las superficies de metal. Almacene la fumigadora en un lugar seco.

## PROPUESTA 65

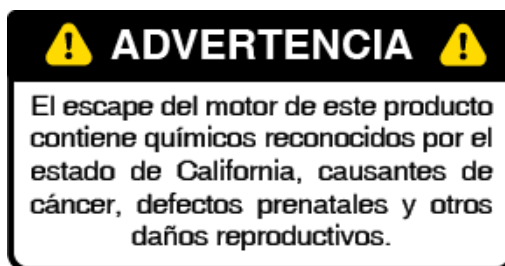

# CARDINAL

CPS435  
FUMIGADORA DE MOCHILA

Lista de Repuestos

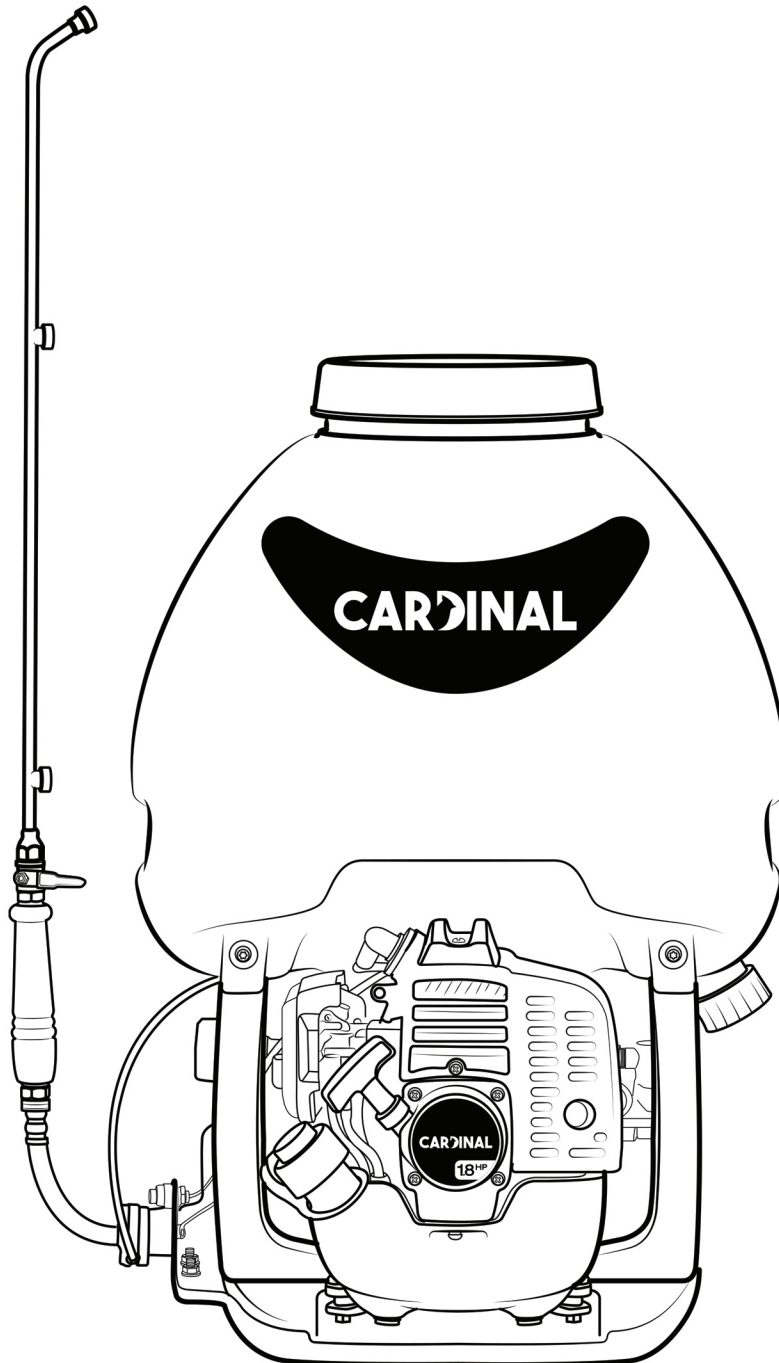



**FUMIGADORA DE MOCHILA**  
**DIAGRAMA DEL TANQUE Y MARCO**  
**SKU: CPS435**

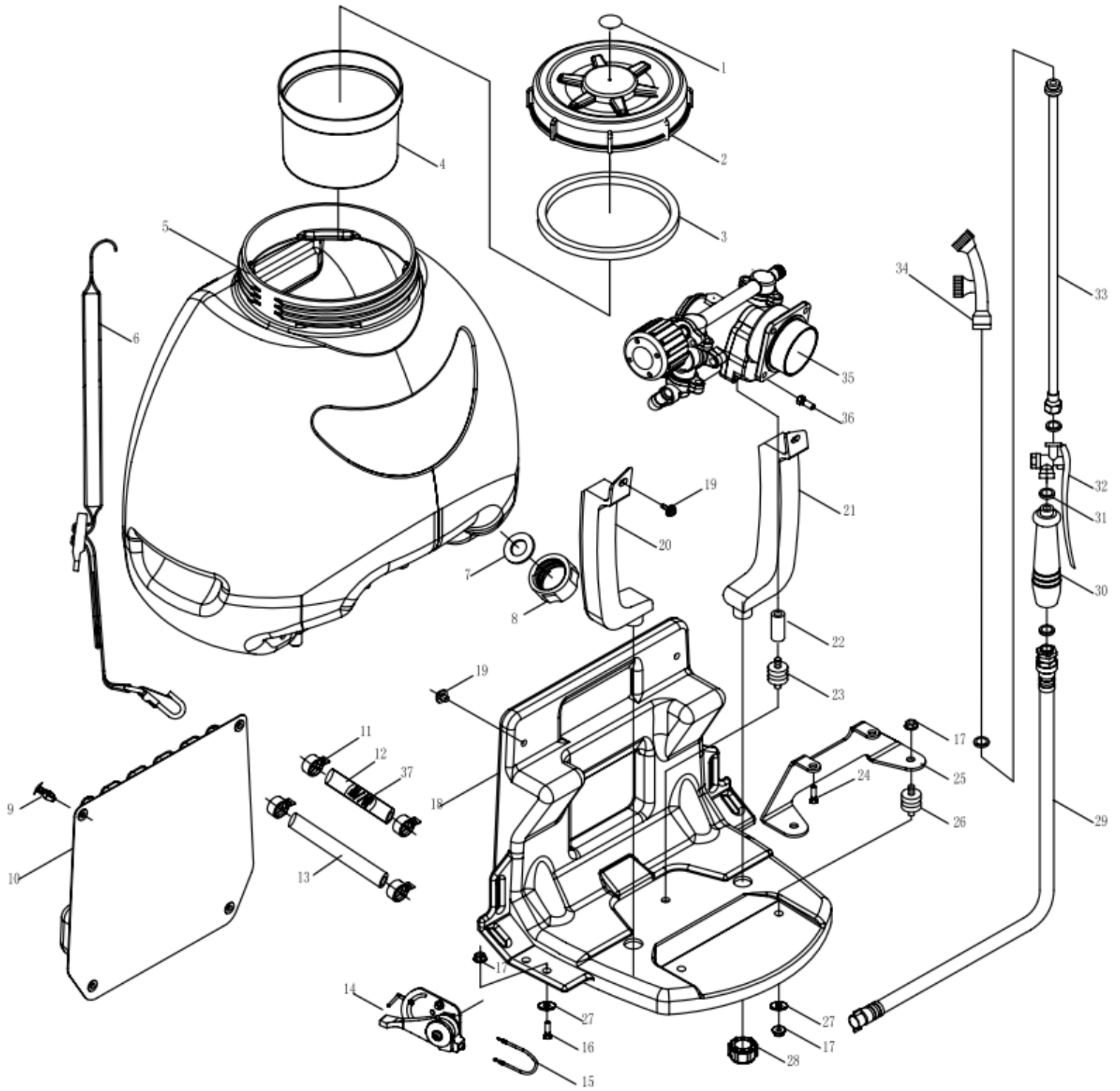



**FUMIGADORA DE MOCHILA**  
**DIAGRAMA DEL TANQUE Y MARCO**  
**SKU: CPS435**

NO.	Part NO.	Part Name	Qty.
1	3WZ-6D.1-5	LID	1
2	3WZ-6D.1-1	LID	1
3	3WZ-6D.1-4	SEALING WASHER	1
4	3WZ-6D.1.2	FILTER ASSM	1
5	3WZ-6F.1.1	CHEMICAL TANK	1
6	6MF-18-44-YT	BANDS ASSM	2
7	3WF-3A.1-2	SEALING WASHER	1
8	3WZ-6.5-1	LID	1
9	3WF-14-13	PLASTIC CLICK	4
10	3WZ-9.1	BACK DACK ASSM	1
11	QC/T621 Q673B15	CLIP	4
12	GB13527.1LS-10×2.5×140	TUBE	1
13	GB13527.1LS-10×2.5×340	TUBE	1
14	3WZ-9.5	SWITH	1
15	3WZ-4C.3	FREL THROTTLE	1
16	GB/T29.2+GB/T96	SCREW ASSY M6×20	2
17	GB/T6177.1 M6	NUT M6	7
18	3WZ-6-4	FRAME	1
19	GB/T823+GB/T96	SCREW M6×12	4
20	3WZ-6-9	LEFT SUPPORT	1
21	3WZ-6-5	RIGHT SUPPORT	1
22	6MSW-5-7B-1	SUPPORT MOUNT	1
23	3WZ-7B.2B	RUBBER MOUNT	1
24	GB70+GB93+GB97	SCREW ASSEM 5×20	2
25	3WZ-6F-1C	CONNECT PLATE	1
26	3WZ-6.1	RUBBER MOUNT	2
27	GB/T 96	WASHER 6	5
28	3WZ-6-2	PLASTIC NUT	2
29	3WZ-6.6	RUBBER TUBE ASSY	1
30	3WZ-4.11	HANDLE	1
31	3WZ-4-10	SEAL RING	4
32	3WZ-7E.1-2	VALVE	1
33	3WZ-4.13	STAIGHT SPRAYING TUBE	1
34	3WZ-6B-HYUNDAI-8	NOZZLE	1
35	3WZ-7B.5A	PISTON PUMP	1
36	GB/T 9074.13	SCREW M6×16	4
37	3WZ-4.7.4-2A	SPRING	1

**FUMIGADORA DE MOCHILA**  
**DIAGRAMA DE LA BOMBA**  
**SKU: CPS435**

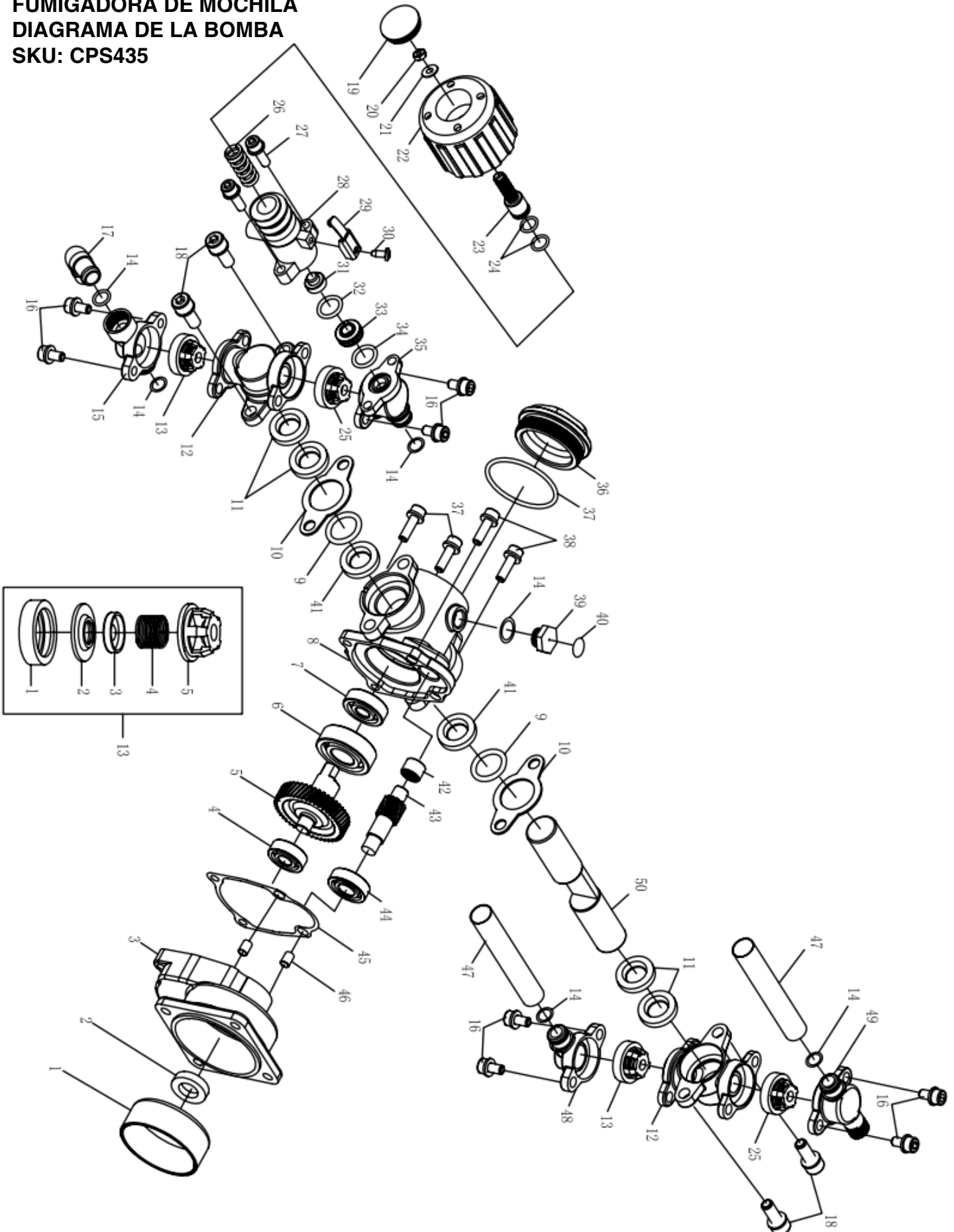

**FUMIGADORA DE MOCHILA**  
**DIAGRAMA DE LA BOMBA**  
**SKU: CPS435**

NO.	Part NO.	Part Name	Qty.
1	3WZ-7B.5-1	CLUTCH DRUM COVER	1
2	1E36F.2	SEAL	1
3	3WZ-7B.5.1-1B	CONNECTING BASE	1
4	GB/T276	BEARING 6000/P6	1
5	3WZ-7B.5.1-3	WHEEL	1
6	GB/T276	BEARING 6204 P6	1
7	GB/T276	BEARING 6301 P5	1
8	3WZ-7B.5.1-2A	NOUMENON	1
9	GB/T3452.1	O-RING 21.2×1.8	2
10	3WZ-7B.5-6	BAFFLE	2
11	3WZ-7B.5.3-4	WATER SEAL	4
12	3WZ-7B.5.3-3	CYLINDER STATOT	2
13	3WZ-7B.5.2A	CHECK VALVE	2
14	GB/T6659	O-RING 10×2	6
15	3WZ-7B.5.4-1	WATER CHAMBER B	1
16	GB70.1+GB93	SCREW ASSM M6X12	8
17	3WZ-7B.5-5A	WATER INLET	1
18	GB70.1+GB93	SCREW ASSM M8X20	4
19	3WZ-7B.5.5-8	HANDLE CAP	1
20	GB6172	NUT M8	1
21	GB97.1	WASHER 8	1
22	3WZ-7B.5.5-1	HANDLE	1
23	3WZ-7B.5.5-3A	REGULATING SCREW	1
24	GB/T6659	O-RING 10×1.8	2
25	3WZ-7B.5.2	CHECK VALVE	2
26	3WZ-7B.5.5-5	SPRING	1
27	GB70.1	SCREW ASSM M6X16	2
28	3WZ-7B.5.5-2	VALVE	1
29	3WZ-7B.5.5.1A	BATTERY BOARD	1
30	GB845ST4.2X10	SCREW ASSEM	1
31	3WZ-7B.5.5-4	SPRING SEAT 1	1
32	GB3452.1	O-RING 12.5×2.65	1
33	3WZ-7B.5.5-7	VALVE SEAT	1
34	GB3452.1	O-RING 11.8×1.8	1
35	3WZ-7B.5.3-2	DISCHARGE METAL A	1
36	3WZ-10.1-1	BOX BACK COVER	1
37	GB/T3452.1	O-RING 46.2×2.65	1

**FUMIGADORA DE MOCHILA**  
**DIAGRAMA DE LA BOMBA**  
**SKU: CPS435**

38	GB70.1+GB93	SCREW ASSM M6X20	4
39	3WZ-7B.5-2A	BOLT	1
40	3WZ-7B.5-7	PASTER	1
41	3WZ-7B.5.1-7	OIL SEAL	2
42	GB/T290 HK1010	BEARING	1
43	3WZ-7B.5.1-3	GEAR SHAFT	1
44	GB/T276	BEARING 6001 P5	1
45	3WZ-10.1.1-5A	SEALING WASHER	1
46	6MF-30.1-14	PIN	2
47	3WZ-10.1-2	TUBE	2
48	3WZ-7B.5.3-1	WATER CHAMBER A	1
49	3WZ-7B.5.4-2	DISCHARGE METAL B	1
50	3WZ-10.1.1-4	PLUNGER	1
13-1	3WZ-7B.5.2-1	BALL SEAT	1
13-2	3WZ-7B.5.2-2	VALVE DISK	1
13-3	3WZ-7.5.2-3	VALVE BLOCK	1
13-4	3WZ-7B.5.2-4A	VALVE SPRING	1
13-5	3WZ-7B.5.2-5	VALVE BONNET	1



FUMIGADORA DE MOCHILA  
DIAGRAMA DEL MOTOR  
SKU: CPS435

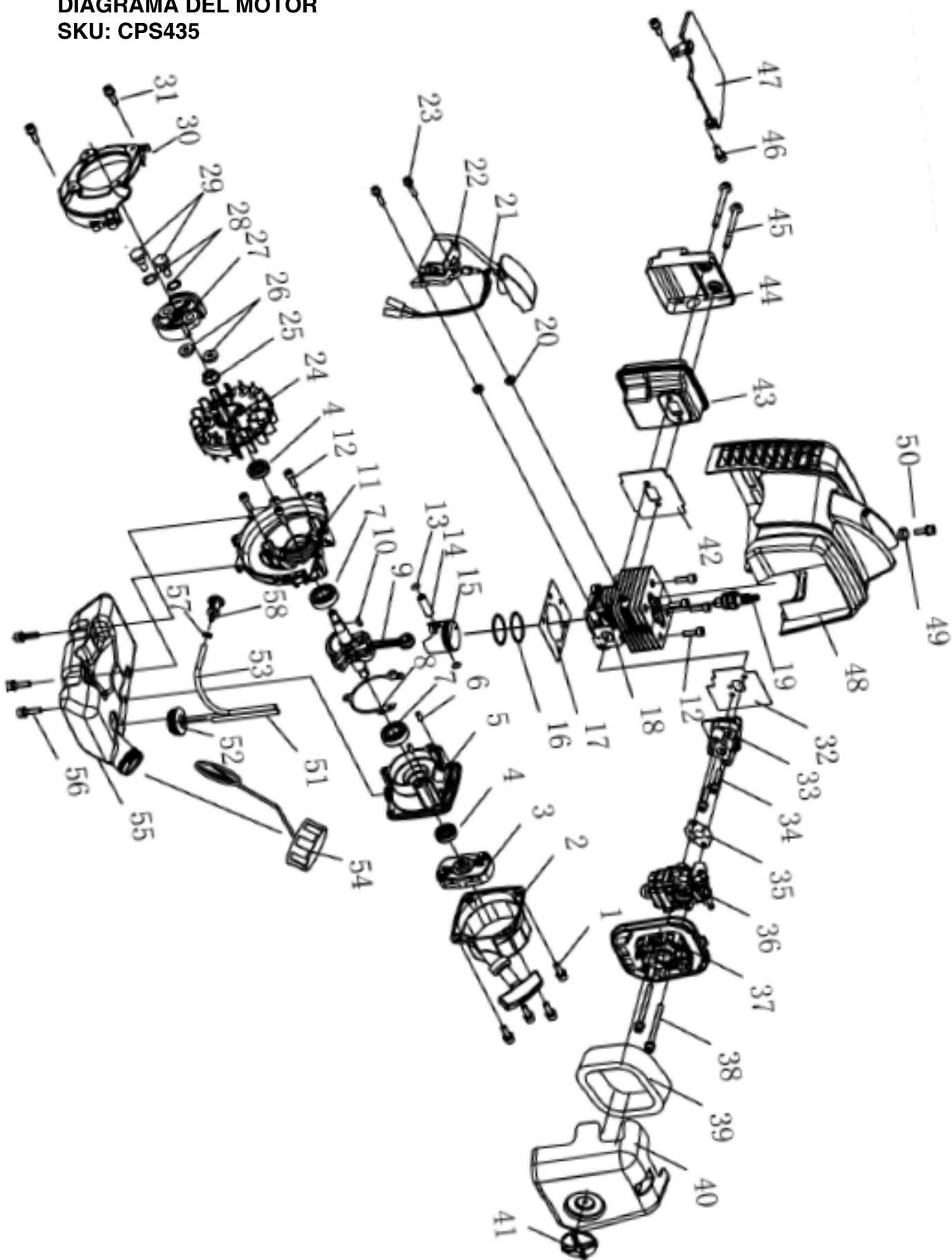

**FUMIGADORA DE MOCHILA**  
**DIAGRAMA DEL MOTOR**  
**SKU: CPS435**

NO.	Part NO.	Part Name	Qty.
1	GB70.1+GB93+GB97	SCREW M5×16	4
2	P23.10A	STARTER	1
3	P23.9A	GUIDE COVER ASS'Y	1
4	1E36F.2	OIL SEAL	2
5	P23.11-2	CRANK CASE R	1
6	GB/T119.1	PIN 4×H8×8	2
7	GB/T276	BEARING 6001/P53	2
8	P23.11-3	GASKET CRANK CASE	1
9	P23.6A.1	CRANK SHAFT ASSY	1
10	1E40FP-3Z.3-1	KEY	1
11	P23.11-1	CRANK CASE F	1
12	GB/T70.1	SCREW M5×16	7
13	1E34F.6-2	RING SNAP	2
14	1E31F.4-2	PISTON PIN	1
15	P23.6A-1	PISTON	1
16	P23.6-2	RING PISTON	2
17	P23-2	GASKET CYLINDER	1
18	P23-1	CYLINDER	1
19	CMR6A	SPARK PLUG	1
20	P40-5	SPACER IG COIL	2
21	1E40F-5.3.1	WIRE LEAD ASSY	1
22	HP23.2.1-SZ.2	IG COIL	1
23	GB70.1+GB93+GB97	SCREW M4×20	2
24	HP23.2.1-SZ.1	ROTOR MAGNET	1
25	GB/T6177	NUT M8	1
26	1E34F-11	WAVE WASHER	2
27	1E34F.10	CLUTCH ASSY	1
28	1E34F-13	WASHER	2
29	1E34F-12	CLUTCH BOLT	2
30	HP23-1	FAN COVER	1
31	GB70.1+GB93+GB97	SCREW M5×18	3
32	P23-7	GASKET INSULATOR	1
33	P23.3	INSULATOR	1
34	GB70.1+GB93+GB97	SCREW M5×25	2
35	1E36F-2A-1	GASKET CARBURETOR	1
36	1E34F-2E.1A	CARBURETOR	1
37	1E34F.1.1	CLEANER BASE ASSY	1

**FUMIGADORA DE MOCHILA**  
**DIAGRAMA DEL MOTOR**  
**SKU: CPS435**

NO.	Part NO.	Part Name	Qty.
38	GB70.1+GB97.1	SCREW M5×60	2
39	1E34F.1-1	AIR FILTER ELEMENT	1
40	HP23.1-1	COVER CLEANER	1
41	1E34FG.1.1	KNOB COVER	1
42	1E34F-3	GASKET MUFFLER	1
43	1E34F-2E.2	MUFFLER	1
44	HP23-5A	COVER	1
45	HP23-8	SCREW M5×55-10.9	2
46	GB70.1+GB93+GB97	SCREW M5×14	2
47	HP23-2	CLAPBOARD	1
48	HP23.3	TOP COVER	1
49	1E33F-4	SPACER IG COIL	1
50	GB70.1+GB93+GB97	SCREW M5×18	1
51	1E44F-E.5.1-2-EPA	FUEL PIPE $\phi 5 \times \phi 2.5 \times 100$	1
52	1E36FF.8.1-1	PLUG	1
53	1E44F-E.5.1-1-EPA	FUEL PIPE $\phi 5.5 \times \phi 3 \times 165$	1
54	1E32FL.6.2B	TANK CAP ASSY	1
55	HP23.6.1	FUEL TANK	1
56	GB70.1+GB93+GB97	SCREW M5×16	3
57	P23.12-1	SNAP RINGS	1
58	P40.12.2-3A	FILTER	1





# TOMAHAWK

## 2020 PRODUCT CATALOG

### COMPACTION



HONDA  
ENGINES

**3,550 lbs/ft Vibratory Rammer**  
Part#: TR68H

3.6 HP Honda GXR120 Engine  
Easily achieve a 100% compaction rating  
3-in-One Fuel System with carburetor protection  
13" x 11" plate for narrow trenches and corners  
3 Year Engine Warranty & 1 Year Product Warranty



HONDA  
ENGINES

**3,400 lbs/ft Plate Compactor**  
Part#: TPC90H

5.5 HP Honda GX160 Engine  
Easily achieve a 100% compaction rating  
22" x 20" cold, rolled steel beveled base plate  
Includes 3.5 gallon water tank for asphalt compaction  
3 Year Engine Warranty & 1 Year Product Warranty



KOHLER  
ENGINES

**3,000 lbs/ft Plate Compactor**  
Part#: TPC80

6 HP Kohler Command PRO Engine  
Easily achieve a 100% compaction rating  
16.5" x 21.5" plate for narrow trenches and corners  
Optional Honda Engine model: TPC80H  
3 Year Engine Warranty & 1 Year Product Warranty

### FINISHING



**6.5 Gal Backpack Concrete Sprayer**  
Part#: TCS6.5

Maintain constant, adjustable pressure up to 435 PSI  
Achieve superior concrete finishes with even spraying  
Spray 15,000 sq ft in less than 10 minutes  
Compatible with major manufacturer wands  
1 Year Product Warranty



HONDA  
ENGINES

**1.6 HP Vibratory Concrete Screed**  
Part#: TVSA-H

1.6 HP Honda GX35 Engine  
Aluminum Magnesium blades available from 8ft - 14ft  
Finish concrete 4X faster than other screed methods  
360° adjustable handle placement  
3 Year Engine Warranty & 1 Year Product Warranty



HONDA  
ENGINES

**6" Early Entry Green Concrete Saw**  
Part#: TFS6H

5.5 HP Honda GX160 Engine  
Maximum cutting depth of 1 3/16 inches  
OSHA compliant vacuum port for dust collection  
Includes 6" early entry concrete blade  
3 Year Engine Warranty & 1 Year Product Warranty

### GENERATORS



INVERTER SERIES

**2000 Watt Inverter Generator**  
Part#: TG2000i

2000 Max Watts, 1600 Rated Watts  
Run Time of 8 hours on 1 gallon of gas  
OSHA and GFCI Compliant  
Parallel technology capable for double the power  
2 Year Product Warranty



INVERTER SERIES

**3500 Watt Inverter Generator**  
Part#: TG3500i

3500 Max Watts, 3000 Rated Watts  
Run Time of 20 hours on 3.5 gallon of gas  
OSHA and GFCI Compliant  
Parallel technology capable for double the power  
2 Year Product Warranty



**4000 & 7000 Watt Generators**  
Part#: TG4000 & TG7000

4000 / 7000 Max Watts, 2500 / 5500 Rated Watts  
Run Time of 8 hours at 50% Load  
OSHA and GFCI Compliant  
Wheel kits available for more jobsite portability  
2 Year Product Warranty

HAVE QUESTIONS?

Contact us. *We're here to help!*

Email us at [sales@tomahawk-power.com](mailto:sales@tomahawk-power.com)



USE CODE  
**SAVE10**  
AT CHECKOUT FOR  
**10% OFF**  
YOUR NEXT ORDER\*

**WELDING / POWER**

INVERTER SERIES



**120 Amp Portable Welder Generator**  
Part#: TWG120A

Steady 120 Amp DC welding output  
60% Duty Cycle for extended use  
Suitable for welding rods from 6010 to 6013  
Includes wheel kit for job site portability  
2 Year Product Warranty

INVERTER SERIES



**210 Amp Portable Welder Generator**  
Part#: TWG210A

Steady 50 - 210 Amp DC welding output  
60% Duty Cycle for extended use  
Suitable for welding rods from 6010 to 7024  
Electric Key Start with battery included  
2 Year Product Warranty



**7500 & 9000 Watt Generators**  
Part#: TG7500 & TG9000

7500 / 9000 Max Watts, 6500 / 8500 Rated Watts  
Run Time of 10 hours at 50% Load  
7 gallon fuel tank for extended use  
Electric Key Start with battery included on TG9000  
2 Year Product Warranty

**PEST CONTROL**



**3.7 Gallon 3HP Backpack Fogger**  
Part#: TMD14

Turbo Boosted Pump with 40ft + Horizontal Reach  
Sprays 1 acre in 30 minutes  
10X Faster than Manual Pump Sprayers  
Converts to Leaf Blower with 200 MPH Air Velocity  
1 Year Engine Warranty & 1 Year Product Warranty



**5 Gallon 1.8HP Backpack Sprayer**  
Part#: TPS25

Reach Up to 30ft Horizontal Reach  
Sprays 1 acre in 15 minutes  
10X Faster than Manual Pump Sprayers  
Commercial Grade Pump  
1 Year Engine Warranty & 1 Year Product Warranty



**4 Gallon 3HP Backpack Spreader**  
Part#: TGS30

Reach Up to 30ft Horizontal Reach  
Covers 1 acre in less than 30 minutes  
20X Faster than Manual Broadcast Spreaders  
Converts to Fogger with Liquid Tank Accessory  
1 Year Engine Warranty & 1 Year Product Warranty

**AND MORE**



**8" Gas Powered Concrete Scarifier**  
Part#: TSCAR8H

5.5 HP Honda GX160 Engine  
Remove traffic lines at 800 - 1,000 linear ft/hr  
Tungsten Carbide Blade Kit Available  
OSHA approved dust port for silica vacuum removal  
3 Year Engine Warranty & 1 Year Product Warranty

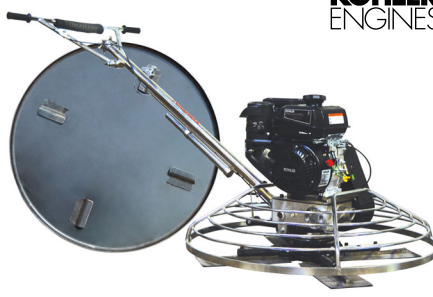

**36" & 46" Concrete Power Trowel**  
Part#: TPT36K & TPT46K

6 HP Kohler CH260 & 9.5 HP Kohler CH395 Engines  
Adjust trowel blade pitch from 0-28°  
60-115 RPM rotor speed for superior concrete finishes  
Includes float pan and trowel blades  
3 Year Engine Warranty & 1 Year Product Warranty



**2" and 3" Trash Water Pumps**  
Part#: TW2 & TW3

Moves liquids at a rate up to 9,240 gallons/hour  
Handle solids up to 0.6"  
Cast iron impeller for smooth performance  
6.5 HP engine protected by rugged all purpose frame  
1 Year Product Warranty

(866) 577-4476

\* Visit [www.tomahawk-power.com](http://www.tomahawk-power.com) for terms and conditions. Coupon must be redeemed at checkout at [www.tomahawk-power.com](http://www.tomahawk-power.com). Coupon may be subject to change and/or expire at any time, without notice.

[www.tomahawk-power.com](http://www.tomahawk-power.com)



## Power Your World

Cardinal understands to keep a job-site running smoothly the proper equipment and spare parts are needed at the drop of a hat. With same day shipping and faster delivery times, count on Cardinal to keep you powered throughout the day! With long lasting parts and engines, Cardinal equipment will be the star of your tool shed for years to come.

# CARDINAL

A Tomahawk Power, LLC Brand  
San Diego, CA

**Sales and Service**  
(866) 577-4476  
sales@tomahawk-power.com

[www.tomahawk-power.com](http://www.tomahawk-power.com)

## TOMAHAWK

