

CarScan[®] Scan Tool



OWNER'S MANUAL

RepairSolutions 2

Table of Contents

SAFETY PRECAUTIONS	
SAFETY FIRST!	1
SCAN TOOL CONTROLS	
CONTROLS AND INDICATORS	2
DISPLAY FUNCTIONS	4
BATTERY REPLACEMENT	5
USING THE SCAN TOOL	
CODE RETRIEVAL PROCEDURE	7
THE SYSTEM MENU	12
VIEWING OEM ENHANCED DTCs (except Ford/Mazda)	12
VIEWING OEM ENHANCED DTCs (Ford/Mazda only)	13
VIEWING ABS DTCs	15
VIEWING SRS DTCs	16
VIEWING TPMS DTCs	18
NETWORK TEST	19
ERASING DIAGNOSTIC TROUBLE CODES (DTCs)	21
ABOUT REPAIRSOLUTIONS 2®	23
CONNECTING TO BLUETOOTH / WIFI	24
LIVE DATA MODE	
VIEWING LIVE DATA	25
CUSTOMIZING LIVE DATA (PIDs)	26
RECORDING (CAPTURING) LIVE DATA	28
LIVE DATA PLAYBACK	31
ADDITIONAL TESTS	
SYSTEM CHECKS MENU	33
PERFORMING SERVICE RESETS	36
PERFORMING A SERVICE CHECK	41
BATTERY/ALTERNATOR TEST	42
VIEWING DRIVE CYCLE PROCEDURES	44
USING THE DLC LOCATOR	46
VIEWING VEHICLE INFORMATION	46
VIEWING THE FIRMWARE VERSION	48
THE TOOL LIBRARY	48
ADJUSTMENTS AND SETTINGS	51
USING SCAN TOOL MEMORY	
VIEWING DATA IN MEMORY	54
WARRANTY AND SERVICING	
LIMITED ONE YEAR WARRANTY	57
SERVICE PROCEDURES	57

SAFETY FIRST!

This manual describes common test procedures used by experienced service technicians. Many test procedures require precautions to avoid accidents that can result in personal injury, and/or damage to your vehicle or test equipment. Always read your vehicle's service manual and follow its safety precautions before and during any test or service procedure. **ALWAYS** observe the following general safety precautions:



When an engine is running, it produces carbon monoxide, a toxic and poisonous gas. To prevent serious injury or death from carbon monoxide poisoning, operate the vehicle **ONLY** in a **well-ventilated** area.



To protect your eyes from propelled objects as well as hot or caustic liquids, **always** wear **approved** safety eye protection.



When an engine is running, many parts (such as the coolant fan, pulleys, fan belt etc.) turn at high speed. To avoid serious injury, always be aware of moving parts. Keep a safe distance from these parts as well as other potentially moving objects.



Engine parts become very hot when the engine is running. To prevent severe burns, avoid contact with hot engine parts.



Before starting an engine for testing or troubleshooting, make sure the parking brake is engaged. Put the transmission in **park** (for automatic transmission) or **neutral** (for manual transmission). Block the drive wheels with suitable blocks.



Connecting or disconnecting test equipment when the ignition is **ON** can damage test equipment and the vehicle's electronic components. Turn the ignition **OFF** before connecting the Scan Tool to or disconnecting the Scan Tool from the vehicle's Data Link Connector (DLC).



To prevent damage to the on-board computer when taking vehicle electrical measurements, always use a digital multimeter with at least 10 megOhms of impedance.



Fuel and battery vapors are highly flammable. To prevent an explosion, keep all sparks, heated items and open flames away from the battery and fuel / fuel vapors. **DO NOT SMOKE NEAR THE VEHICLE DURING TESTING.**



Don't wear loose clothing or jewelry when working on an engine. Loose clothing can become caught in the fan, pulleys, belts, etc. Jewelry is highly conductive, and can cause a severe burn if it makes contact between a power source and ground.

CONTROLS AND INDICATORS

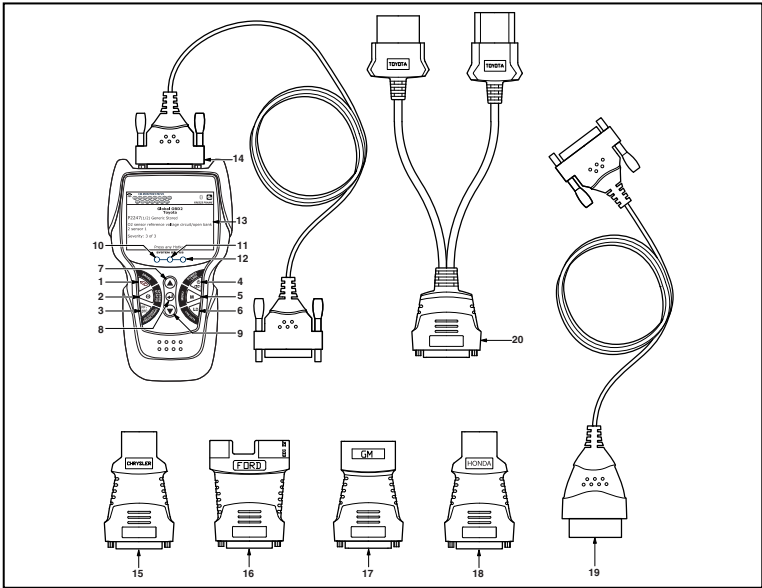







Figure 1. Controls and Indicators

See Figure 1 for the locations of items 1 through 20, below.

1.  **ERASE button** - Erases Diagnostic Trouble Codes (DTCs), and "Freeze Frame" data from your vehicle's computer, and resets Monitor status.
2.  **SYSTEM MENU button** - When pressed, displays the System Test Menu.
3. **DTC/FF button** - Displays the DTC View screen and/or scrolls the LCD display to view DTCs and Freeze Frame data.
4.  **POWER/LINK button** - When not connected to a vehicle, turns the Scan Tool "On" and "Off". When connected to a vehicle, links the Scan Tool to the vehicle's PCM.
5. **M button** - When pressed, displays the Main Menu.
6. **LD button** - When pressed while linked to a vehicle, places the Scan Tool in Live Data mode.
7.  **UP button** - When in MENU mode, scrolls UP through the menu options. When LINKED to a vehicle, scrolls UP through the current display screen to display any additional data.
8.  **ENTER button** - When in MENU mode, confirms the selected option or value.

9. **▼ DOWN button** - When in MENU mode, scrolls DOWN through the menu options. When LINKED to a vehicle, scrolls DOWN through the current display screen to display any additional data.
10. **GREEN LED** - Indicates that all engine systems are running normally (all Monitors on the vehicle are active and performing their diagnostic testing, and no DTCs are present).
11. **YELLOW LED** - Indicates there is a possible problem. A "Pending" DTC is present and/or some of the vehicle's emission monitors have not run their diagnostic testing.
12. **RED LED** - Indicates there is a problem in one or more of the vehicle's systems. The red LED is also used to show that DTC(s) are present. DTCs are shown on the Scan Tool's display. In this case, the Malfunction Indicator ("Check Engine") lamp on the vehicle's instrument panel will light steady on.
13. **Display** - Color LCD display shows menu and submenus, test results, Scan Tool functions and Monitor status information. See **DISPLAY FUNCTIONS**, following, for more details.
14. **CABLE** - Connects the Scan Tool to the vehicle's Data Link Connector (DLC).



Items 15 through 20 are available with purchase of the optional OBD1 Adaptor Kit and OBD1 firmware upgrade.

15. **CHRYSLER Connector Cable Adaptor** - Installs on cable (item 14) when connecting to a Chrysler OBD1 Data Link Connector.
16. **FORD Connector Cable Adaptor** - Installs on cable (item 14) when connecting to a Ford OBD1 Data Link Connector.
17. **GM Connector Cable Adaptor** - Installs on cable (item 14) when connecting to a GM OBD1 Data Link Connector.
18. **HONDA Connector Cable Adaptor** - Installs on cable (item 14) when connecting to a Honda OBD1 Data Link Connector.
19. **OBD II Cable** - Connects the scan tool to the vehicle's Data Link Connector (DLC) when retrieving codes from OBD II systems.
20. **TOYOTA Connector Cable Adaptor** - Installs on cable (item 14) when connecting to a Toyota OBD1 Data Link Connector.

DISPLAY FUNCTIONS

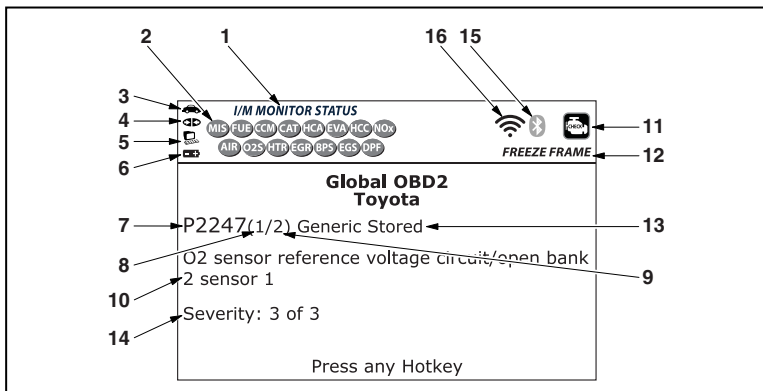

Figure 2. Display Functions

See Figure 2 for the locations of items 1 through 16, below.

1. **I/M MONITOR STATUS field** - Identifies the I/M Monitor status area.
2. **Monitor icons** - Indicate which Monitors are supported by the vehicle under test, and whether or not the associated Monitor has run its diagnostic testing (Monitor status). A solid green icon indicates the associated Monitor has completed its diagnostic testing. A flashing red icon indicates that the vehicle supports the associated Monitor, but the Monitor has not yet run its diagnostic testing.
3. **Vehicle icon** - When visible, indicates that the Scan Tool is being powered through the vehicle's DLC connector.
4. **Link icon** - When visible, indicates the Scan Tool is communicating with the vehicle's computer.
5. **Computer icon** - When visible, indicates the Scan Tool is linked to a personal computer.
6. **Scan Tool Internal Battery icon** - When visible, indicates the Scan Tool batteries are "low" and should be replaced. If the batteries are not replaced when the battery symbol is "on", all 3 LEDs will light to warn that the batteries need replacement. No data will be displayed on screen when all 3 LEDs are lit.
7. **DTC Display Area** - Displays the Diagnostic Trouble Code (DTC) number. Each fault is assigned a code number that is specific to that fault. The DTC number is color-coded as follows:
 - **RED** - Indicates the currently displayed DTC is a STORED or PERMANENT DTC.
 - **YELLOW** - Indicates the currently displayed DTC is a PENDING DTC.

- **GREEN** - In cases where no codes are retrieved, a "No DTCs are presently stored in the vehicle's computer" message is shown in green.
8. **Code Number Sequence** - The Scan Tool assigns a sequence number to each DTC that is present in the computer's memory, starting with "1." This number indicates which code is currently displayed. Code number "1" is always the highest priority code, and the one for which "Freeze Frame" data has been stored.



If "1" is a "Pending" code, there may or may not be "Freeze Frame" data stored in memory.

9. **Code Enumerator** - Indicates the total number of codes retrieved from the vehicle's computer.
10. **Test Data Display Area** - Displays DTC definitions, Freeze Frame data and other pertinent test information messages.
11. **SYSTEM icon** - Indicates the system with which the code is associated:



MIL icon



ABS icon



SRS icon

12. **FREEZE FRAME icon** - Indicates that there is Freeze Frame data from "Priority Code" (Code #1) stored in the vehicle's computer memory.
13. **Code type** - Indicates the type of code being displayed; **Generic Stored**, **Generic Pending**, **Generic permanent**, etc.
14. **Severity** - Indicates the level of severity for the priority code (code number "1"), as follows:
- 1 - Service should be scheduled and repairs made when convenient. This DTC typically has no immediate threat to essential system components in the short term.
 - 2 - Repair immediately if drivability issues are present. Threat to essential system components if not repaired as soon as possible.
 - 3 - Stop and repair vehicle immediately to prevent interrelated failures. Harmful and damaging to essential system components.
15. **Bluetooth icon** – Indicates communication status with a compatible Innova mobile application (please visit www.innova.com/apps for more information). A solid blue icon indicates an active Bluetooth connection has been established. A solid grey icon indicates Bluetooth is not connected.
16. **Wi-Fi icon** – Indicates Wi-Fi communication status. When ON, indicates the scan tool is linked to a Wi-Fi network. When OFF, indicates there is no Wi-Fi connection.

BATTERY REPLACEMENT



Replace batteries when the battery symbol is visible on display and/or the 3 LEDs are all lit and no other data is visible on screen.

1. Locate the battery cover on the back of the Scan Tool.

2. Slide the battery cover off (use your fingers).
3. Replace batteries with three AA-size batteries (for longer life, use Alkaline-type batteries).
4. Reinstall the battery cover on the back of the Scan Tool.

Adjustments After Battery Installation

The first time the Scan Tool is turned on, you must select the desired display language (English, French or Spanish) and unit of measurement (Standard or metric) as follows:

5. Press the **POWER/LINK**  button to turn the Scan Tool "ON."
 - The Select Language screen displays.
6. Select the desired display language, then press **ENTER** .
 - The Select Unit screen displays.
7. Select the desired unit of measurement, then press **ENTER** .
 - The Scan Tool's Firmware Version screen displays.



After the initial language and unit of measurement selections are performed, these, as well as other settings, can be changed as desired. Proceed to "ADJUSTMENTS AND SETTINGS" on page 51 for further instructions.

CODE RETRIEVAL PROCEDURE

Retrieving and using Diagnostic Trouble Codes (DTCs) for troubleshooting vehicle operation is only one part of an overall diagnostic strategy.

Never replace a part based only on the DTC definition. Each DTC has a set of testing procedures, instructions and flow charts that must be followed to confirm the location of the problem. Always refer to the vehicle's service manual for detailed testing instructions.



Check your vehicle thoroughly before performing any test.



ALWAYS observe safety precautions whenever working on a vehicle.

1. Turn the ignition off.
2. Locate the vehicle's 16-pin Data Link Connector (DLC).



Some DLCs have a plastic cover that must be removed before connecting the Scan Tool cable connector.



If the Scan Tool is ON, turn it OFF BEFORE connecting the Scan Tool to the DLC.

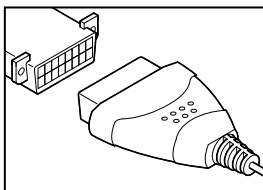
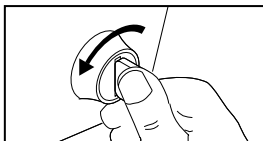

3. Connect the Scan Tool to the vehicle's DLC. The cable connector is keyed and will only fit one way.
 - If you have problems connecting the cable connector to the DLC, rotate the connector 180°.
 - If you still have problems, check the DLC on the vehicle and on the Scan Tool.
4. Turn the ignition on. **DO NOT** start the engine.
5. When the Scan Tool is properly connected to the vehicle's DLC, the unit automatically turns ON.
 - If the unit does not power on automatically, it may indicate there is no power present at the vehicle's DLC connector. Check the fuse panel and replace any burned-out fuses.
 - If replacing the fuse(s) does not correct the problem, consult your vehicle's repair manual to identify the proper computer (PCM) fuse/circuit, and perform any necessary repairs before proceeding.





- The Scan Tool automatically starts a check of the vehicle's computer to determine which type of communication protocol it is using. When the Scan Tool identifies the computer's communication protocol, a communication link is established.



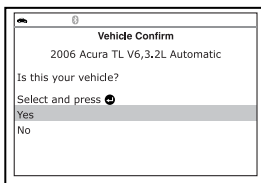

A **PROTOCOL** is a set of rules and procedures for regulating data transmission between computers, and between testing equipment and computers. As of this writing, five different types of protocols (ISO 9141, Keyword 2000, J1850 PWM, J1850 VPW and CAN) are in use by vehicle manufacturers.

- If the Scan Tool fails to link to the vehicle's computer, a "Communication Error" message shows.
 - Ensure your vehicle is OBD2 compliant.
 - Verify the connection at the DLC, and verify the ignition is ON.
 - Turn the ignition OFF, wait 5 seconds, then back ON to reset the computer.
 - Press **POWER/LINK**  to continue.
 - If the Scan Tool **cannot** link to the vehicle's computer after three attempts, the message "Contact Technical Support" displays.
 - Press **SYSTEM MENU**  to return to the System Menu.
 - Turn the ignition off, and disconnect the Scan Tool.
 - Contact Technical Support for assistance.
- If the Scan Tool can decode the Vehicle Identification Number (VIN) for the vehicle under test, the Confirm Vehicle screen displays.

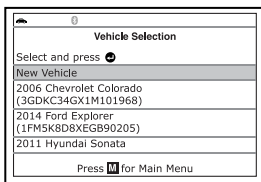

- If the information shown is correct for the vehicle under test, select **Yes**, then press to **ENTER** . Proceed to step 10.
 - If the information shown is not correct for the vehicle under test, or if you wish to manually select the vehicle, select **No**, then press **ENTER** . Proceed to step 8.
 - If the Scan Tool **cannot** decode the Vehicle Identification Number (VIN) for the vehicle under test, the Select Vehicle screen displays. Proceed to step 8.
- When **No** is selected from the Vehicle information screen, the Select Vehicle screen displays. The Select Vehicle screen lists the three most recently tested vehicles.



- To select a previously tested vehicle, select the desired vehicle, then press **ENTER** . Proceed to step 10.

- To select a new vehicle, select **New Vehicle**, then press **ENTER** . Proceed to step 9.
9. When **New Vehicle** is chosen from the Select Vehicle screen, the Select Year screen displays.
- Select the desired vehicle model year, then press **ENTER** to continue.
 - The Select Make screen displays.
 - Select the desired vehicle make, then press **ENTER** to continue.
 - The Select Model screen displays.
 - Select the desired vehicle model, then press **ENTER** to continue.
 - The Select Engine screen displays.
 - Select the desired vehicle engine size, then press **ENTER** to continue.
 - The Select Transmission screen displays.
 - Select the desired transmission type, then press **ENTER** to continue. The Vehicle Information screen displays.
 - If the information shown is correct for the vehicle under test, select **Yes**, then press **ENTER** . Proceed to step 10.
 - If the information shown is not correct for the vehicle under test, or if you wish to reselect the vehicle, select **No**, then press **ENTER** to return to the Select Year screen.

Vehicle Selection		
Select and press		
Previous	1996	1997
1998	1999	2000
2001	2002	2003
2004	2005	2006
2007	2008	Next

Vehicle Selection	
2006	
Select and press	
Previous	Acura
AM General	Audi
BMW	Buick
Cadillac	Next

Vehicle Selection	
2006 Acura	
Select and press	
Previous	CSX
MDX	RL
RSX	TL
TSX	Not Listed

Vehicle Selection	
2006 Acura TL	
Select and press	
Previous	V6,3.2L
Not Listed	

Vehicle Selection	
2006 Acura TL V6,3.2L	
Select and press	
Previous	Manual
Automatic	

Vehicle Confirm	
2006 Acura TL V6,3.2L Automatic	
Is this your vehicle?	
Select and press	
Yes	
No	

Emission Related Engine DTCs	
No Powertrain DTCs or Freeze Frame Data is presently stored in the vehicle's computer.	
Press any Hotkey	

10. After approximately 10–60 seconds, the Scan Tool will **retrieve** and **display** any Diagnostic Trouble Codes, Monitor Status and Freeze Frame Data retrieved from the vehicle's computer memory.

- The Scan Tool will display a code only if codes are present. If no codes are present, the message "No Powertrain DTCs or Freeze Frame Data presently stored in the vehicle's computer" displays.

- The Scan Tool is capable of retrieving and storing up to 32 codes in memory, for immediate or later viewing.

11. Refer to DISPLAY FUNCTIONS on page 4 for a description of display elements.



In the case of long code definitions, a small arrow is shown in the upper/lower right-hand corner of the Scan Tool display area to indicate the presence of additional information.

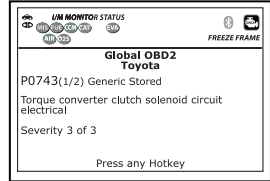

If a definition for the currently displayed code is not available, an advisory message shows.

12. Read and interpret Diagnostic Trouble Codes/system condition using the display and the green, yellow and red LEDs.



The green, yellow and red LEDs are used (with the display) as visual aids to make it easier to determine engine system conditions.

- **Green LED** – Indicates that all engine systems are “OK” and operating normally. All monitors supported by the vehicle have run and performed their diagnostic testing, and no trouble codes are present. All Monitor icons will be solid.

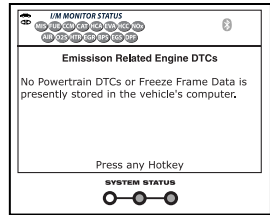

- **Yellow LED** – Indicates one of the following conditions:

A. Green LED – Indicates that all engine systems are “OK” and operating normally. All monitors supported by the vehicle have run and performed their diagnostic testing, and no trouble codes are present. All Monitor icons will be solid.

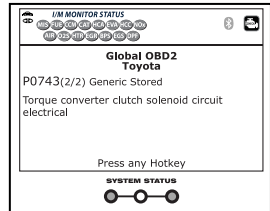

B. MONITOR NOT RUN STATUS – If the display shows a zero (indicating there are no DTC's present in the vehicle's computer memory), but the yellow LED is illuminated, it may be an indication that some of the Monitors supported by the vehicle have not yet run and completed their diagnostic testing. Check the display for confirmation. All Monitor icons that are blinking have not yet run and completed their diagnostic testing; all Monitor icons that are solid have run and completed their diagnostic testing.

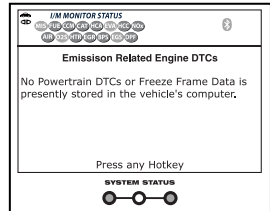

- **Red LED** – Indicates there is a problem with one or more of the vehicle's systems. The red LED is also used to indicate that DTC(s) are present. In this case, the Malfunction Indicator (Check Engine) lamp on the vehicle's instrument panel will be illuminated.

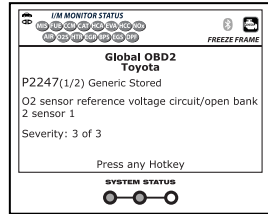

- DTC's that start with "P0", "P2" and some "P3" are considered Generic (Universal). All Generic DTC definitions are the same on all OBD2 equipped vehicles. The Scan Tool automatically displays the code definitions (if available) for Generic DTC's.
- DTC's that start with "P1" and some "P3" are Manufacturer specific codes and their code definitions vary with each vehicle manufacturer.

13. If more than one DTC was retrieved, and to view Freeze Frame Data, press and release **DTC/FF**, as necessary.

- Each time **DTC/FF** is pressed and released, the Scan Tool will scroll and display the next DTC in sequence until all DTCs in its memory have displayed.
- Freeze Frame Data (if available) will display after DTC #1.
- In OBD2 systems, when an emissions-related engine malfunction occurs that causes a DTC to set, a record or snapshot of engine conditions at the time that the malfunction occurred is also saved in the vehicle's computer memory. The record saved is called Freeze Frame data. Saved engine conditions include, but are not limited to: engine speed, open or closed loop operation, fuel system commands, coolant temperature, calculated load value, fuel pressure, vehicle speed, air flow rate, and intake manifold pressure.

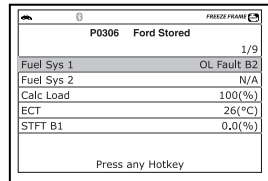

If more than one malfunction is present that causes more than one DTC to be set, only the code with the highest priority will contain Freeze Frame data. The code designated "01" on the Scan Tool display is referred to as the PRIORITY code, and Freeze Frame data always refers to this code. The priority code is also the one that has commanded the MIL on.

14. When the last retrieved DTC has been displayed and **DTC/FF** is pressed, the Scan Tool returns to the "Priority" Code.
15. Determine engine system(s) condition by viewing the Scan Tool's display for any retrieved Diagnostic Trouble Codes, code definitions and Freeze Frame data, interpreting the green, yellow and red LEDs.
- If DTC's were retrieved and you are going to perform the repairs yourself, proceed by consulting the Vehicle's Service Repair Manual for testing instructions, testing procedures, and flow charts related to retrieved code(s).





- To prolong battery life, the Scan Tool automatically shuts “Off” approximately three minutes after it is disconnected from the vehicle. The DTCs retrieved, Monitor Status and Freeze Frame data (if any) will remain in the Scan Tool’s memory, and may be viewed at any time by turning the unit “On”. If the Scan Tool’s batteries are removed, or if the Scan Tool is re-linked to a vehicle to retrieve codes/data, any prior codes/data in its memory are automatically cleared.

THE SYSTEM MENU

The System Menu provides the ability to retrieve “enhanced” DTCs, Anti-Lock Brake System (ABS), Supplemental Restraint System (SRS) DTCs and Tire Pressure Monitoring System DTCs for most BMW, Chrysler/Jeep, Ford/Mazda, GM/Isuzu, Honda/Acura, Hyundai, Mercedes Benz, Nissan, Toyota/Lexus, Volkswagen and Volvo vehicles. The types of enhanced data available depends on the vehicle make. You can also return to the Global OBD2 mode.



Depending on the vehicle under test, some features and functions may not be available.

- To access the System Menu, press the **SYSTEM MENU**  button. Use the **UP**  and **DOWN**  buttons, as necessary, to highlight the desired option, then press the **ENTER**  button to view the selected information.

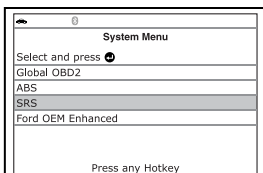

To view ABS DTCs: Select **ABS** from the System Menu. Refer to VIEWING ABS DTCs on page 15 to view ABS DTCs for your vehicle.

To view SRS DTCs: Select **SRS** from the System Menu. Refer to VIEWING SRS DTCs on page 16 to view SRS DTCs for your vehicle.

To view TPMS DTCs: Select **TPMS** from the System Menu. Refer to VIEWING TPMS DTCs on page 18 to view TPMS DTCs for your vehicle.



To view OEM enhanced DTCs: Select **OEM Enhanced** from the System Menu. Refer to VIEWING OEM ENHANCED DTCs on page 12 to view OEM enhanced DTCs for your vehicle.

To perform a Network Test: Select **All Module Scan** or **Select Modules**, as desired. Refer to NETWORK TEST on page 19 to view DTCs for other modules.

VIEWING OEM ENHANCED DTCs (except Ford/Mazda)

When (make) OEM Enhanced is chosen from the System Menu, the Scan Tool retrieves OEM enhanced DTCs from the vehicle’s computer.

1. A “One moment please” message displays while the Scan Tool retrieves the selected DTCs.
 - If the Scan Tool fails to link to the vehicle’s computer, a “Communication Error” message shows.

- Ensure your vehicle is OBD2 compliant.
 - Verify the connection at the DLC, and verify the ignition is ON.
 - Turn the ignition OFF, wait 5 seconds, then back ON to reset the computer.
 - Press **POWER/LINK**  to continue.
- If the Scan Tool **cannot** link to the vehicle's computer after three attempts, the message "Contact Technical Support" displays.
- Press **SYSTEM MENU**  to return to the System Menu.
 - Turn the ignition off, and disconnect the Scan Tool.
 - Contact Technical Support for assistance.
2. Refer to DISPLAY FUNCTIONS on page 3 for a description of LCD display elements.



If the definition for the currently displayed code is not available, an advisory message shows.







I/M MONITOR STATUS icons are not displayed when viewing enhanced DTCs.

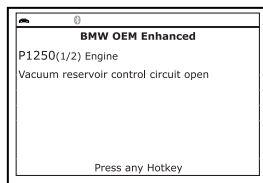

In the case of long code definitions, a small arrow is shown in the upper/lower right-hand corner of the code display area to indicate the presence of additional information.



- If no codes are present, the message "No OEM Enhanced DTC's are presently stored in the vehicle's computer" shows. Press **SYSTEM MENU**  to return to the System Menu.
3. If more than one code was retrieved press **DTC/FF**, as necessary, to display additional codes one at a time.
- Whenever the Scroll function is used to view additional codes, the Scan Tool's communication link with the vehicle's computer disconnects. To re-establish communication, press **POWER/LINK**  again.
4. When the last retrieved DTC has been displayed and **DTC/FF** is pressed, the Scan Tool returns to the "Priority" Code.
- To exit the enhanced mode, press **SYSTEM MENU**  to return to the System Menu. Select **Global OBD**, then press **ENTER**  to return to the Global OBD2 mode.







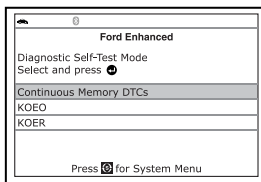

VIEWING OEM ENHANCED DTCs (Ford/Mazda only)



*Mazda Enhanced DTCs are available for **Mazda-branded Ford vehicles only.***

When **Ford OEM Enhanced** is chosen from the System Menu, the Ford OEM Enhanced menu displays. You may view DTCs for either the “Continuous Memory Test”, “KOE0 (Key On Engine Off) Test” or “KOER (Key On Engine Running) Test.”



1. Select the desired option, then press **ENTER** .
 - If **KOER** is selected, an advisory message shows.
 - Start and warm the engine to normal operating temperature, then press **ENTER** . Proceed to step 3.
2. If **KOE0** or **Continuous Memory** is selected, an “instructional” message shows.
 - Turn the ignition OFF, then back ON. Press **ENTER** . Proceed to step 3.
3. A “One moment please” message displays while the test is in progress.
 - If the Scan Tool fails to link to the vehicle's computer, a “Communication Error” message shows.
 - Ensure your vehicle is OBD2 compliant.
 - Verify the connection at the DLC, and verify the ignition is ON.
 - Turn the ignition OFF, wait 5 seconds, then back ON to reset the computer.
 - Press **POWER/LINK**  to continue.
 - If the Scan Tool **cannot** link to the vehicle's computer after three attempts, the message “Contact Technical Support” displays.
 - Press **SYSTEM MENU**  to return to the System Menu.
 - Turn the ignition off, and disconnect the Scan Tool.
 - Contact Technical Support for assistance.
 - If the **KOER** Test was selected, and the vehicle's engine *is not* running, an advisory message shows.
 - Start the engine and press **ENTER**  to try again, or, press **SYSTEM MENU**  to return to the System Menu.
 - If the **KOE0** Test was selected, and the vehicle's engine *is running*, an advisory message shows.
 - Turn the ignition OFF then back ON and press **ENTER**  to try again, or, press **SYSTEM MENU**  to return to the System Menu.
4. If the **KOER** test was selected, an “instructional” message shows.
 - Turn the steering wheel to the left, then release.
 - Press and release the brake pedal.



- Cycle the overdrive switch (if equipped).
 - A "One moment please" message displays while the test is in progress.
5. Refer to DISPLAY FUNCTIONS on page 3 for a description of LCD display elements.

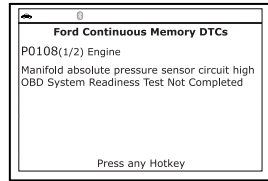

I/M MONITOR STATUS icons are not displayed when viewing enhanced DTCs.



In the case of long code definitions, a small arrow is shown in the upper/lower right-hand corner of the code display area to indicate the presence of additional information.

- If no codes are present, a "System Pass" message displays. Press any Hotkey.
6. If more than one code was retrieved press **DTC/FF** to display additional codes one at a time.
7. When the last retrieved DTC has been displayed and **DTC/FF** is pressed, the Scan Tool returns to the "Priority" Code.
- To view *additional* enhanced DTCs, repeat steps 1 through 5, above.
 - To exit the enhanced mode, press **SYSTEM MENU**  to return to the System Menu. Select **Global OBD**, then press **ENTER**  to return to the Global OBD2 mode.

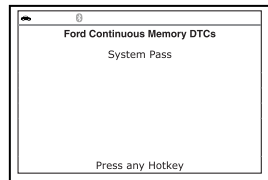



VIEWING ABS DTCs



Refer to the manufacturer's website for vehicle makes covered.

Reading ABS DTCs

1. When **ABS** is chosen from the System Menu, a "One moment please" message displays while the Scan Tool retrieves the selected DTCs.
 - If ABS functionality is not supported, an advisory message shows. Press **SYSTEM MENU**  to return to the System Menu.
 - If the Scan Tool fails to link to the vehicle's computer, a "Communication Error" message shows.
 - Ensure your vehicle is OBD2 compliant.
 - Verify the connection at the DLC, and verify the ignition is ON.

- Turn the ignition OFF, wait 5 seconds, then back ON to reset the computer.
 - Press **POWER/LINK**  to continue.
 - If the Scan Tool **cannot** link to the vehicle's computer after three attempts, the message "Contact Technical Support" displays.
 - Press **SYSTEM MENU**  to return to the System Menu.
 - Turn the ignition off, and disconnect the Scan Tool.
 - Contact Technical Support for assistance.
2. Refer to DISPLAY FUNCTIONS on page 3 for a description of LCD display elements.



If the definition for the currently displayed code is not available, an advisory message shows.







I/M MONITOR STATUS icons are not displayed when viewing ABS DTCs.

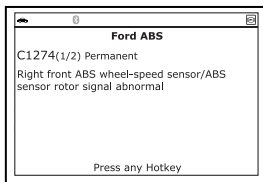

In the case of long code definitions, a small arrow is shown in the upper/lower right-hand corner of the code display area to indicate the presence of additional information.





- If no codes are present, the message "No ABS DTC's are presently stored in the vehicle's computer" shows. Press **SYSTEM MENU**  to return to the System Menu.
3. If more than one code was retrieved press **DTC/FF** to display additional codes one at a time.
- Whenever the Scroll function is used to view additional codes, the Scan Tool's re-communication link with the vehicle's computer disconnects. To re-establish communication, press **POWER/LINK**  again.
4. When the last retrieved DTC has been displayed and **DTC/FF** is pressed, the Scan Tool returns to the "Priority" Code.
- To exit the enhanced mode, press **SYSTEM MENU**  to return to the System Menu. Select **Global OBD**, then press **ENTER**  to return to the Global OBD2 mode.

VIEWING SRS DTCs



Refer to the manufacturer's website for vehicle makes covered.

Reading SRS DTCs

1. When **SRS DTCs** is chosen from the System Menu, a "One moment please" message displays while the Scan Tool retrieves the selected DTCs.
 - If SRS functionality is not supported, an advisory message shows. Press **SYSTEM MENU**  to return to the System Menu.
 - If the Scan Tool fails to link to the vehicle's computer, a "Communication Error" message shows.
 - Ensure your vehicle is OBD2 compliant.
 - Verify the connection at the DLC, and verify the ignition is ON.
 - Turn the ignition OFF, wait 5 seconds, then back ON to reset the computer.
 - Press **POWER/LINK**  to continue.
 - If the Scan Tool **cannot** link to the vehicle's computer after three attempts, the message "Contact Technical Support" displays.
 - Press **SYSTEM MENU**  to return to the System Menu.
 - Turn the ignition off, and disconnect the Scan Tool.
 - Contact Technical Support for assistance.
2. Refer to **DISPLAY FUNCTIONS** on page 3 for a description of LCD display elements.



If the definition for the currently displayed code is not available, an advisory message shows.



I/M MONITOR STATUS icons are not displayed when viewing SRS DTCs.



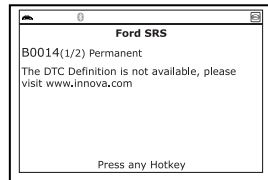

In the case of long code definitions, a small arrow is shown in the upper/lower right-hand corner of the code display area to indicate the presence of additional information.

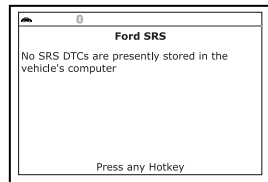

- If no codes are present, the message "No SRS DTC's are presently stored in the vehicle's computer" shows.



3. If more than one code was retrieved press **DTC/FF** to display additional codes one at a time.
 - Whenever the Scroll function is used to view additional codes, the Scan Tool's communication link with the vehicle's computer disconnects. To re-establish communication, press **POWER/LINK**  again.
4. When the last retrieved DTC has been displayed and **DTC/FF** is pressed, the Scan Tool returns to the "Priority" code.



- To exit the enhanced mode, press **SYSTEM MENU**  to return to the System Menu. Select **Global OBD**, then press **ENTER**  to return to the Global OBD2 mode.

VIEWING TPMS DTCs



Refer to the manufacturer's website for vehicle makes covered.

Reading TPMS DTCs

1. When **TPMS DTCs** is chosen from the System Menu, a "One moment please" message displays while the Scan Tool retrieves the selected DTCs.
 - If TPMS functionality is not supported, an advisory message shows. Press **SYSTEM MENU**  to return to the System Menu.
 - If the Scan Tool fails to link to the vehicle's computer, a "Communication Error" message shows.
 - Ensure your vehicle is OBD2 compliant.
 - Verify the connection at the DLC, and verify the ignition is ON.
 - Turn the ignition OFF, wait 5 seconds, then back ON to reset the computer.
 - Press **POWER/LINK**  to continue.
 - If the Scan Tool **cannot** link to the vehicle's computer after three attempts, the message "Contact Technical Support" displays.
 - Press **SYSTEM MENU**  to return to the System Menu.
 - Turn the ignition off, and disconnect the Scan Tool.
 - Contact Technical Support for assistance.
2. Refer to **DISPLAY FUNCTIONS** on page 3 for a description of LCD display elements.



If the definition for the currently displayed code is not available, an advisory message shows.







I/M MONITOR STATUS icons are not displayed when viewing SRS DTCs.

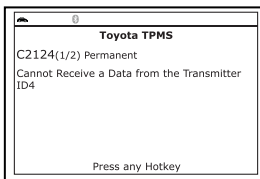

In the case of long code definitions, a small arrow is shown in the upper/lower right-hand corner of the code display area to indicate the presence of additional information.

- If no codes are present, the message "No TPMS DTC's are presently stored in the vehicle's computer" shows.
3. If more than one code was retrieved press **DTC/FF** to display additional codes one at a time.







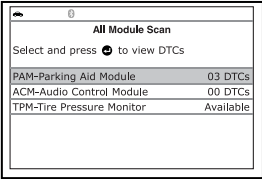

- Whenever the Scroll function is used to view additional codes, the Scan Tool's communication link with the vehicle's computer disconnects. To re-establish communication, press **POWER/LINK**  again.
4. When the last retrieved DTC has been displayed and **DTC/FF** is pressed, the Scan Tool returns to the "Priority" code.
 - To exit the enhanced mode, press **SYSTEM MENU**  to return to the System Menu. Select **Global OBD**, then press **ENTER**  to return to the Global OBD2 mode.

NETWORK TEST

The Network Test lets you perform a scan of all vehicle modules, or of a single selected module, to retrieve DTCs associated with the module(s).

To scan *all* modules:

1. Select **All Module Scan** from the System Menu, then press **ENTER** .
 - A "One moment please" message displays while the Scan Tool scans all available modules.
 - When the scan is complete, the Available Systems screen displays. The screen shows the number of DTCs recorded for each available module.
- 
- | All Module Scan | |
|---|-----------|
| Select and press  to view DTCs | |
| PAM-Parking Aid Module | 03 DTCs |
| ACM-Audio Control Module | 00 DTCs |
| TPM-Tire Pressure Monitor | Available |
2. Select the module for which you wish to view DTCs, then press **ENTER** . A "One moment please" message displays while the requested DTCs are retrieved.
 - If the Scan Tool fails to link to the selected module, a "Communication Error" message shows.
 - Ensure your vehicle is OBD2 compliant.
 - Verify the connection at the DLC, and verify the ignition is ON.
 - Turn the ignition OFF, wait 5 seconds, then back ON to reset the computer.
 - Press **POWER/LINK**  to continue, or, press **System Menu**  to return to the System Menu.
 - If the selected module does not support the "Read DTC" function, an advisory message displays. Press **System Menu**  to return to the System Menu, or, press **M** to access the Main Menu.

3. Refer to DISPLAY FUNCTIONS on page 4 for a description of LCD display elements.



If the definition for the currently displayed code is not available, an advisory message shows.

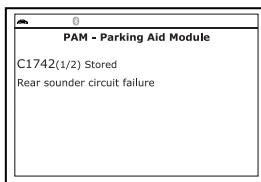

I/M MONITOR STATUS icons are not displayed when using the Network Test function.



In the case of long code definitions, a small arrow is shown in the upper/lower right-hand corner of the code display area to indicate the presence of additional information.

- If no codes are present, the message "No (system name) DTC's are presently stored in the vehicle's computer" shows. Press **System Menu** to return to the System Menu.
4. If more than one code was retrieved press **DTC/FF** to display additional codes one at a time.
 - Whenever the Scroll function is used, the Scan Tool's communication link with the vehicle's computer disconnects. To re-establish communication, press **POWER/LINK** again.
 5. When the last retrieved DTC has been displayed and **DTC/FF** is pressed, the Scan Tool returns to the first code.
 - To exit the enhanced mode, Press **System Menu** to return to the System Menu. Select **Global OBD**, then press **ENTER** to return to the Global OBD2 mode.

To scan a selected module:

1. Choose **Select Modules** from the System Menu, then press **ENTER** .









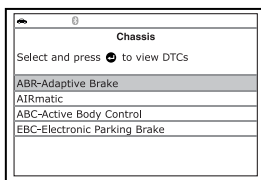

 - If the Select Group screen displays, select the group (**Drive, Chassis, Body**, etc.) containing the module you wish to scan, then press **ENTER** . Proceed to step 2.
 - If the Select Group screen does not display, proceed to step 2.

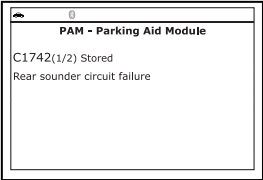
2. The Available Systems screen displays. Select the desired module, then press **ENTER** .

 - A "One moment please" message displays while the requested DTCs are retrieved.

3. Select the module for which you wish to view DTCs, then press **ENTER** . A "One moment please" message displays while the requested DTCs are retrieved.
 - If the Scan Tool fails to link to the selected module, a "Communication Error" message shows.



- Ensure your vehicle is OBD2 compliant.
 - Verify the connection at the DLC, and verify the ignition is ON.
 - Turn the ignition OFF, wait 5 seconds, then back ON to reset the computer.
 - Press **POWER/LINK**  to continue, or, press **System Menu**  to return to the System Menu.
- If the selected module does not support the "Read DTC" function, an advisory message displays. Press **System Menu**  to return to the System Menu, or, press **M** to access the Main Menu.
4. Refer to DISPLAY FUNCTIONS on page 4 for a description of LCD display elements.
- 
-  *If the definition for the currently displayed code is not available, an advisory message shows.*
 -  *I/M MONITOR STATUS icons are not displayed when using the Network Test function.*
 -  *In the case of long code definitions, a small arrow is shown in the upper/lower right-hand corner of the code display area to indicate the presence of additional information.*
- If no codes are present, the message "No (system name) DTC's are presently stored in the vehicle's computer" shows. Press **System Menu**  to return to the System Menu.
5. If more than one code was retrieved press **DTC/FF** to display additional codes one at a time.
- Whenever the Scroll function is used, the Scan Tool's communication link with the vehicle's computer disconnects. To re-establish communication, press **POWER/LINK**  again.
6. When the last retrieved DTC has been displayed and **DTC/FF** is pressed, the Scan Tool returns to the first code.
- To exit the enhanced mode, press **System Menu**  to return to the System Menu. Select **Global OBD**, then press **ENTER**  to return to the Global OBD2 mode.

ERASING DIAGNOSTIC TROUBLE CODES (DTCs)



When the Scan Tool's ERASE function is used to erase DTCs from the vehicle's on-board computer, "Freeze Frame" data and manufacturer-specific-enhanced data are also erased. "Permanent" DTCs ARE NOT erased by the ERASE function.

If you plan to take the vehicle to a Service Center for repair, **DO NOT** erase the codes from the vehicle's computer. If the codes are erased, valuable information that might help the technician troubleshoot the problem will also be erased.

Erase DTCs from the computer's memory as follows:



When DTCs are erased, the I/M Readiness Monitor Status program resets the status of all Monitors to a not run condition. To set all Monitors to a DONE status, an OBD2 Drive Cycle must be performed.

1. If not connected already, connect the Scan Tool to the vehicle's DLC, and turn the ignition "On." (If the Scan Tool is already connected and linked to the vehicle's computer, proceed directly to step 3. If not, continue to step 2.)

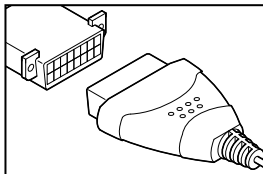

2. Perform the Code Retrieval procedure as described on page 7.

- **To erase OBD2 DTCs:** Wait until the codes are displayed, then proceed to step 3.

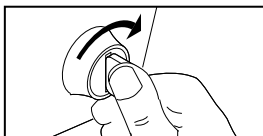

- **To erase enhanced or ABS, SRS, TPMS or Network DTCs:** Press **SYSTEM MENU** to display the System Menu. Select the desired option, then press **ENTER** . Perform the appropriate Code Retrieval procedure and then proceed to step 3.

3. Press and release **ERASE** . A confirmation message shows.

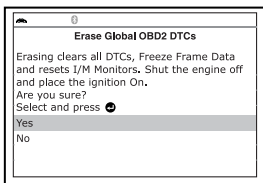

- If you are sure you want to proceed, select **Yes**, then press **ENTER** to continue.
- If you do not want to proceed, select **No**, then press **ENTER** to cancel the erase procedure.

4. If you chose to erase DTCs, a "One moment please..." message displays while the erase function is in progress.



*If the vehicle's engine is running, an advisory message shows. Turn the engine OFF, then turn the ignition back to ON. DO NOT start the engine. Press **ENTER** to continue.*

- If the erase was successful, a confirmation message shows. The Scan Tool automatically relinks to the vehicle's computer after 3 seconds.

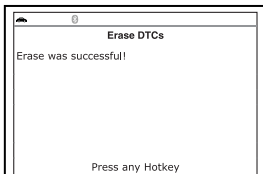

*If the erase was not successful and ECU error code \$22 is present, an advisory message displays. Start the engine and maintain vehicle speed at 0, then press **ERASE** to try again.*

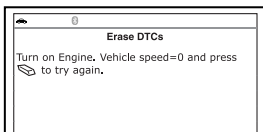

- If the erase was not successful, an advisory message shows on the display indicating the erase request was sent to the vehicle's computer. The Scan Tool automatically relinks to the vehicle's computer after 3 seconds.



Erasing DTCs does not fix the problem(s) that caused the code(s) to be set. If proper repairs to correct the problem that caused the code(s) to be set are not made, the code(s) will appear again (and the Check Engine Light will illuminate) as soon as the vehicle is driven long enough for its Monitors to complete their testing.

ABOUT REPAIRSOLUTIONS 2®

RepairSolutions 2® is a web-based service created to assist both Do-It-Yourself and Professional technicians in quickly and accurately diagnosing and repairing today's vehicles. RepairSolutions 2 allows you to view and save the diagnostic data retrieved from a vehicle's on-board computer(s) using your Code Reader. At the core of RepairSolutions 2 is an extensive knowledge database, developed by compiling and analyzing years worth of "real world" vehicle service data. RepairSolutions 2 builds on manufacturer-recommended diagnostic and repair information by providing verified, vehicle-specific fixes supplied by ASE technicians across the country. RepairSolutions 2 also provides access to an extensive knowledge database including:

- **Verified Fixes** – Find the most likely fixes reported and verified by ASE Technicians for the retrieved DTCs.
- **Repair Instructions** – View available repair instructions to properly perform the fix.
- **Video Tutorials** – Watch repair video tutorials for valuable repair tips.
- **Technical Service Bulletins** – Research known problems reported by vehicle manufacturers.
- **Safety Recalls** – Research known safety concerns applicable to a vehicle.

And much more. Please visit www.innova.com for additional information.

Hardware Requirements:

- Innova Scan Tool with Bluetooth/WiFi
- Android or iOS Smart Device

Accessing RepairSolutions 2®

1. Download and install the RepairSolutions 2® app from the App Store (for iOS devices) or Google Play (for Android devices).
2. Launch the RepairSolutions 2 app and log in to your account.
 - If you have not yet established an account, you must register for a FREE RepairSolutions 2 account before proceeding.

3. Connect the Code Reader to a vehicle and establish a Bluetooth or WiFi connection with your Smart Device (refer to CONNECTING TO BLUETOOTH / WIFI, below). Be sure your Smart Device is connected to an available WiFi network.
 - The RepairSolutions 2 app will store two WiFi configurations only.
4. Retrieve diagnostic data (refer to CODE RETRIEVAL PROCEDURE on page 7 for details).
5. The RepairSolutions 2 app automatically displays a report based on the retrieved diagnostic data.
 - If the Code Reader is not connected to WiFi or Bluetooth, vehicle data will not be saved.

CONNECTING TO BLUETOOTH / WIFI

Launch the RepairSolutions2 app and follow the prompts to establish Bluetooth and (optionally) WiFi connections, as follows:

1. Launch the RepairSolutions2 app. Select **Wifi Tools Settings** from the menu. Power on your Code Reader, then select from the list of available devices.
2. When Bluetooth pairing is complete, a confirmation screen displays. Click **Continue**.
 - If a Bluetooth connection cannot be established, an advisory message displays. Tap **Try Again** to repeat the pairing process.
3. Follow the on-screen prompts to connect to an available WiFi network.
 - You can automatically connect to the network your Smart Device is currently connected to, or you can manually connect to another available network.
 - Note that only 2.4GHz networks are supported.
 - If you do not wish to connect to a WiFi network at this time, tap **SKIP**.
4. When WiFi pairing is complete, a confirmation screen displays. Click **Continue** to view the "Setup Complete" message, then click **Continue** to enter RepairSolutions2.
 - If a WiFi connection cannot be established, an advisory message displays. Tap **Try Again** to repeat the pairing process.

The Scan Tool lets you view and/or record "real-time" Live Data. This information includes values (volts, rpm, temperature, speed etc.) and system status information (open loop, closed loop, fuel system status, etc.) generated by the various vehicle sensors, switches and actuators. These are the same signal values generated by the sensors, actuators, switches and/or vehicle system status information used by the vehicle's computer when calculating and conducting system adjustments and corrections.

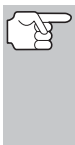

The real time (Live Data) vehicle operating information (values/status) that the computer supplies to the Scan Tool for each sensor, actuator, switch, etc. is called Parameter Identification (PID) Data.

Each PID (sensor, actuator switch, status, etc.) has a set of operating characteristics and features (parameters) that serve to identify it. The Scan Tool displays this information for each sensor, actuator, switch or status that is supported by the vehicle under test.



WARNING: If the vehicle must be driven in order to perform a troubleshooting procedure, **ALWAYS** have a second person help you. One person should drive the vehicle while the other person observes the Scan Tool data. Trying to drive and operate the Scan Tool at the same time is dangerous, and could cause a serious traffic accident.

VIEWING LIVE DATA

1. While linked to the vehicle, start the engine, then press **LD**.
2. A "One moment please . . ." message displays while the Scan Tool establishes communication with the vehicle.
 - If the Scan Tool fails to establish communication with the vehicle, a "Communication Error" message displays.
 - Ensure your vehicle is OBD2 compliant.
 - Verify the connection at the DLC, and verify the ignition is ON.
 - Turn the ignition OFF, wait 5 seconds, then back ON to reset the computer.
 - Press **ENTER**  to continue.
3. Real-time Live Data (PID) information supported by the vehicle under test displays.
 - If Live Data is not supported by the vehicle under test, an advisory message displays. Press **SYSTEM MENU**  to return to the System Menu. Live Data is not available for your vehicle.

Powertrain Live Data	
Select and Press  to graph	
PCM PID	1/113
Fuel Sys 1	N/A
Fuel Sys 2	N/A
Calc Load	47.1(%)
ECT	45(°C)

Press **LD** for LD Menu



Remember, what you are viewing is "real-time" Live Data. The values (volts, rpm, temperature, vehicle speed, system status etc) for the various PIDS displayed may change as the vehicle's operating conditions change.

Live Data Mode

CUSTOMIZING LIVE DATA (PIDs)

- Only a limited amount of PID data can be displayed on the screen at one time. If additional PID data is available, a small arrow is shown on the display. Press **UP ▲** and **DOWN ▼**, as necessary, to view all available PID data.
 - If communication with the vehicle is lost while viewing Live Data, an advisory message displays.
- Press and release **ENTER ↵** to view the currently selected PID in "graph" mode. Press and release **ENTER ↵** again to return to the PID list.
 - You can display a maximum of two PIDs in "graph" mode at any given time.
 - With two PID shown in "graph" mode, press and hold **LD** to superimpose one graph on the other. Release **LD** to separate the graphs.
- Press and hold **ENTER ↵** to view the "expanded" definition for the currently selected PID. Release **ENTER ↵** to return to the PID list.
- If you experience vehicle problems, view and/or compare the Live Data (PID) information displayed on the Scan Tool to specifications in the vehicle's repair manual.

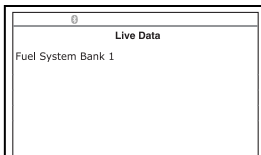
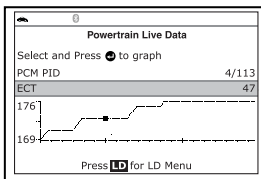
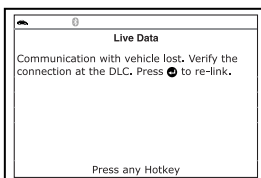









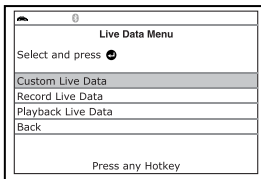

If desired, you can "customize" the Live Data display to show only those PIDs you are interested in viewing. See **Customizing Live Data (PIDs)** below for details. You may also choose to "capture" (record) Live Data for later viewing. See **RECORDING (CAPTURING) LIVE DATA** on page 28 for details.

CUSTOMIZING LIVE DATA (PIDs)

You can customize the Live Data display by placing the Scan Tool in "Custom Live Data" mode and selecting only the PIDs that you wish to display.

- With the Scan Tool in Live Data mode (see **VIEWING LIVE DATA** on page 25), press and hold **LD** until the Live Data Menu displays, then release.
- Select **Custom Live Data**, then press **ENTER ↵**.
 - If the Scan Tool fails to establish communication with the vehicle, a "Communication Error" message displays.
 - Ensure your vehicle is OBD2 compliant.



- Verify the connection at the DLC, and verify the ignition is ON.
 - Turn the ignition OFF, wait 5 seconds, then back ON to reset the computer.
 - Press **POWER/LINK**  to continue.
- If Live Data is not supported by the vehicle under test, an advisory message displays. Press **SYSTEM MENU**  to return to the System Menu.
 - If custom Live Data was previously configured, the Select PIDs to Use screen displays.
 - To use the *existing* custom Live data selections, select **Use existing PIDs**, then press **ENTER** . Proceed to step 5.
 - To configure *new* custom Live Data, select **Select new PIDs**, then press **ENTER** . The Custom Live Data menu displays. Proceed to step 3.
 - If custom Live Data was not previously selected, the Custom Live Data menu displays. Proceed to step 3.
3. Press **UP**  and **DOWN**  to scroll through the available PIDs. When a PID you wish to display is highlighted, press **ENTER**  (a "checkmark" shows to confirm your selection). Repeat until only the PIDs you want to display have all been selected.
 - To deselect a PID, highlight the PID, then press **ENTER** . The checkmark is removed.
 4. When you are finished making your selection(s), press **LD** to continue.
 - If *no PIDs* have been selected, an advisory message displays. Press **ENTER**  to return to the Custom Live Data menu.
 5. The Scan Tool is now in "Custom Live Data" mode. Only the PIDs you selected are shown.
 - To change the current custom Live Data selections, select **Reselect PIDs**, then press **ENTER**  to return to the Custom Live Data menu. Repeat step 3.
 6. To exit the "Custom Live Data" mode, press **LD** to return to the Live Data Menu.

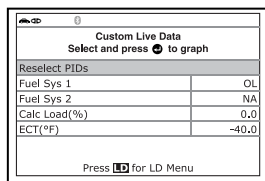
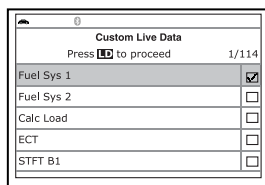

RECORDING (CAPTURING) LIVE DATA

You can record and save several frames of Live Data information for each PID supported by the vehicle in the Scan Tool's memory.

There are two ways that the Scan Tool can record Live Data:







- Record by DTC Trigger
- Record by Manual Trigger



If **POWER/LINK**  is pressed at any time while in Live Data mode, any recorded Live Data will be erased from the Scan Tool's memory.

Record by DTC Trigger

This function automatically records Live Data information when a DTC sets and saves it in the Scan Tool's memory. The recorded data can be a valuable troubleshooting aid, particularly if you are experiencing a fault that is causing a DTC to set. The Scan Tool can record approximately 100 frames of Live Data.

1. With the Scan Tool in Live Data mode (see VIEWING LIVE DATA on page 25), press and hold **LD** until the Live Data Menu displays, then release.
2. Select **Record Live Data**, then press **ENTER** 
 - The Record Live Data Menu displays.
 - If the Scan Tool fails to establish communication with the vehicle, a "Communication Error" message displays.
 - Ensure your vehicle is OBD2 compliant.
 - Verify the connection at the DLC, and verify the ignition is ON.
 - Turn the ignition OFF, wait 5 seconds, then back ON to reset the computer.
 - Press **POWER/LINK**  to continue.
3. Select **Record by DTC Trigger**, then press **ENTER** 
 - The Select PIDs to Record screen displays.
4. Press **UP**  and **DOWN**  to scroll through the available PIDs. When a PID you wish to record is highlighted, press **ENTER**  (a "checkmark" shows to confirm your selection). Repeat until only the PIDs you want to record have all been selected.
 - To deselect a PID, highlight the PID, then press **ENTER** . The checkmark is removed.

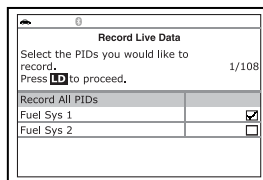

To record all PIDs, select **Record All PIDs**, then press **LD** to continue.

5. When you are finished making your selections, press **LD** to continue.

- If DTCs are presently stored in the vehicle's computer, an advisory message displays. Select **Erase DTCs**, then press **ENTER** \leftarrow . A "One moment please..." message displays while DTCs are erased from the vehicle's computer.

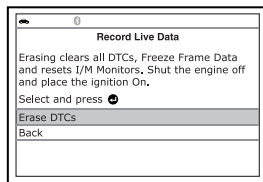

- If the erase was not successful, an advisory message displays.
 - To retry the erase process, verify that the Scan Tool is properly connected to the vehicle's DLC and that the ignition is on. Select **Erase**, then press **ENTER** \leftarrow .
 - To exit the record function, select **Back**, then press **ENTER** \leftarrow to return to the Record Live Data menu.

- The Record Live Data screen displays.

6. Put the engine in the operating condition that causes the DTC to set.

- If necessary, drive the vehicle until you reach the vehicle speed at which the problem occurs.

7. When the Scan Tool detects a fault that causes a DTC to set, it automatically records and saves approximately 100 frames of Live Data information in its memory for each PID selected.

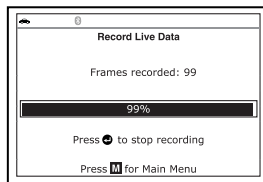





- A progress message shows on the display.
 - You can stop and save recorded Live Data at any time by pressing **ENTER** \leftarrow .
- When recording is complete, a confirmation screen displays. Select **Yes** and press **ENTER** \leftarrow to playback Live Data (see LIVE DATA PLAYBACK on page 31 for details) or select **No** and press **ENTER** \leftarrow to return to the Live Data menu, as desired.
- If recording was not successful, an advisory message shows on the display. Press the **ENTER** \leftarrow button to return to the Record Live Data menu.

Record by Manual Trigger

This option lets you select the precise time at which the Live Data recording will occur. Record by Manual Trigger can be a very valuable tool when troubleshooting intermittent problems that do not meet the requirements for a DTC to set. The Scan Tool can record approximately 100 frames of Live Data.

1. With the Scan Tool in Live Data mode (see VIEWING LIVE DATA on page 25), press and hold **LD** until the Live Data Menu displays, then release.
2. Select **Record Live Data**, then press **ENTER** \leftarrow .
 - The Record Live Data Menu displays.

- If the Scan Tool fails to establish communication with the vehicle, a “Communication Error” message displays.
 - Ensure your vehicle is OBD2 compliant.
 - Verify the connection at the DLC, and verify the ignition is ON.
 - Turn the ignition OFF, wait 5 seconds, then back ON to reset the computer.
 - Press **POWER/LINK**  to continue.
- 3. Select **Record Manually**, then press **ENTER** .
- The Select PIDs to Record screen displays.

4. Press **UP**  and **DOWN**  to scroll through the available PIDs. When a PID you wish to record is highlighted, press **ENTER**  (a “checkmark” shows to confirm your selection). Repeat until only the PIDs you want to record have all been selected.

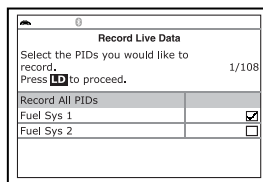

- To deselect a PID, highlight the PID, then press **ENTER** . The checkmark is removed.





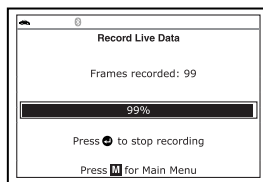

To record all PIDs, select **Record All PIDs**, then press **LD** to continue.

5. When you are finished making your selections, press **LD** to continue.
- The Record Live Data screen displays.



- Highlight **Start Recording**. Put the engine in the operating condition where the problem manifests itself.
 - If necessary, drive the vehicle until you reach the vehicle speed at which the problem occurs.



6. When the problem occurs, press and release **LD**.
- A progress message shows on the display.
 - You can stop and save recorded Live Data at any time by pressing **ENTER** .
 - When recording is complete, a confirmation screen displays. Select **Yes** and press **ENTER**  to playback Live Data (see LIVE DATA PLAYBACK on page 31 for details) or select **No** and press **ENTER**  to return to the Live Data menu, as desired.
 - If recording was not successful, an advisory message displays. Press **ENTER**  to return to the Record Live Data menu.



LIVE DATA PLAYBACK

Once Live Data has been recorded, it is saved in the Scan Tool's memory. You can view recorded Live Data immediately after recording by selecting **Yes** from the Record Live Data confirmation screen (see RECORDING (CAPTURING) LIVE DATA on page 28 for more information), or you can view it later using the "Playback" function.

- With the Scan Tool not connected to a vehicle, press the **POWER/LINK**  button.
 - The "To Link" screen shows on the Scan Tool's display.
- Press and hold the **LD** button until the Live Data Menu displays, then release the **LD** button.
- Select **Playback Live Data**, then press **ENTER** .
 - The Playback Live Data menu displays.





*When you select **Yes** from the Record Live Data confirmation screen, the Scan Tool enters the "Live Data Playback" mode, and the Playback Live Data menu displays.*

- Select **Continuous Playback** or **Frame by Frame**, as desired, then press **ENTER** .
 - The display shows the recorded Live Data, beginning with the "trigger" frame.
 - Only a limited amount of PID data can be displayed on the screen at one time. If additional PID data is available, a small arrow is shown on the display. Press **UP**  and **DOWN** , as necessary, to view all available PID data.
 - When viewing recorded Live Data, look for any irregularities in any of the PID values/signal information (LTFT %, RPM, MAP, TEMP, etc.). If any PIDs are not within specification, or irregularities are detected, follow the procedures in the vehicle's service repair manual to perform additional troubleshooting and repair.

Playback Live Data	
Select and press  to graph	
Frame 13/100 PID 1/5	
Fuel Sys 1	N/A
ECT	46(°C)
STFT B1	49.2(%)
Fuel Pres	45(kPa)

Press **LD** for LD Menu

- When you select **Continuous Playback**, the Scan Tool plays recorded data at a rate of one frame / 15 seconds. When playback is finished, a Playback Complete message displays.
 - To play the data back again, select **Continuous Playback** or **Frame by Frame**, as desired, then press **ENTER** .
 - To exit Live Data Playback mode and return to Live Data mode, select **Exit Playback**, then press **ENTER** .

Playback Live Data	
Continuous Playback is complete.	
Select and press 	
Continuous Playback	
Frame by Frame	
Exit Playback	

Press **LD** for LD Menu

- When **Frame by Frame** is selected, you must scroll the individual frames manually.

Live Data Mode

LIVE DATA PLAYBACK

- When you have viewed all PID information for the current frame of Live Data, select **Next Frame** or **Previous Frame**, as desired, then press **ENTER** ↵.
- To exit Live Data Playback mode, select **Exit Playback**, then press **ENTER** ↵.



*If there is no Live Data currently stored in the Scan Tool's memory, an advisory message shows on the display. Press **LD** to exit the "Live Data Playback" mode.*

In addition to retrieving Diagnostic Trouble Codes (DTCs), you can use the Scan Tool to perform additional diagnostic tests, to view diagnostic and vehicle information stored in your vehicle's on-board computer, and to configure the Scan Tool for your particular needs. Additional tests and related functions are accessed through the Main Menu. The following functions are available:

- **System Tests** – Displays the System Test menu, which lets you retrieve and view results for the O2 Sensor Test and OBD Monitor Test, and lets you initiate a test of the vehicle's EVAP system.
- **Service Reset** – Lets you reset the Oil Maintenance Light, reset the battery monitor system after battery replacement, perform calibration procedures for the vehicle's Steering Angle Sensor (SAS), perform Electronic Parking Brake (EPB) cable replacement and reset, or perform Anti-Lock Brake System (ABS) bleeding.
- **Service Check** – Lets you view the current engine oil level and oil life remaining.
- **Hybrid/EV Battery Test, Battery/Alternator Test** – Performs a check of the vehicle's battery and alternator system (or hybrid/EV battery system) to ensure the system is operating within acceptable limits.
- **Drive Cycle Procedure** – Lets you view drive cycle procedures for a selected vehicle monitor.
- **DLC Locator** – Lets you find the location of the Data Link Connector (DLC) for a specified vehicle.
- **Vehicle Information** – Displays the Vehicle Info menu, which lets you retrieve and view reference information for the vehicle under test.
- **Firmware Version** – Displays the Scan Tool's firmware version.
- **Tool Library** – Displays the Tool Library menu, which provides access to OBD1 and OBD2 DTC libraries and to definitions for Monitor icons and LED indications.
- **Tool Settings** – Displays the Tool Settings menu, which lets you make several adjustments and settings to configure the Scan Tool to your particular needs.

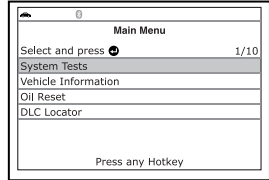

The **System Tests** and **Vehicle Information** options are shown only when the Scan Tool is in Global OBD2 mode.

SYSTEM CHECKS MENU

Additional tests are accessed through the System Checks menu. The following functions are available:

- **O2 Sensor Check** - Retrieves and displays O2 sensor monitor test results from your vehicle's on-board computer.

- **OBD Monitor Check** - Retrieves and displays test results for emission-related powertrain components and systems that are not continuously monitored.
- **EVAP Check** - Performs a leak test for the vehicle's EVAP system.

1. While linked to the vehicle, press **M**.
 - The Main Menu displays.
2. Select **System Checks**, then press **ENTER** .
 - The System Checks menu displays.



If **System Checks** is not shown on the Main Menu, the System Check functions are not available for your vehicle.

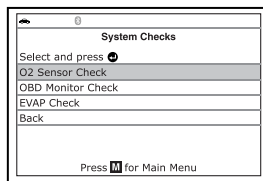

O2 Sensor Check

OBD2 regulations require that applicable vehicles monitor and test operation of the oxygen (O2) sensors to identify problems that can affect fuel efficiency and vehicle emissions. These tests are performed automatically when engine operating conditions are within predefined limits. Results of these tests are stored in the on-board computer's memory.

The **O2 Sensor Check** function lets you retrieve and view O2 sensor monitor test results for the most recently completed tests from your vehicle's on-board computer.



The scan tool does not perform O2 sensor tests, but retrieves results from the most recently performed O2 sensor tests from the on-board computer's memory. You may retrieve O2 sensor test results for only one test of one sensor at any given time.

1. From the System Checks menu, select **O2 Sensor Check**, then press **ENTER** .
2. A "One moment please..." message displays, followed by the select sensor screen.



If O2 sensor check data is not presently stored in the vehicle's computer, an advisory message displays. Press **M** to return to the Main Menu.



If O2 sensor checks are not supported by the vehicle under test, an advisory message displays. Press **M** to return to the Main Menu.

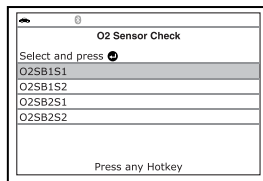

3. Select the O2 sensor for which you wish to view test results, then press **ENTER**  to display the test results.

4. When test results have been retrieved, data for the selected sensor test will show on the Scan Tool's display.
5. When you have finished viewing the retrieved test data:
 - To view test results for the next sensor, select **Next**, then press **ENTER** ↵.
 - To return to the Select Sensor screen, select **Back**, then press **ENTER** ↵.
6. When you have finished viewing test data for all desired sensors, select **Back**, then press **ENTER** ↵ to return to the System Test menu; or, press **M** to return to the Main Menu.

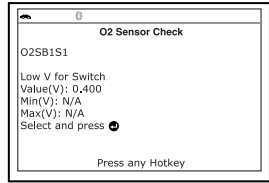

OBID Monitor Check

The **OBID Monitor Check** function retrieves and displays test results for emission-related powertrain components and systems that are not continuously monitored. The tests available are determined by the vehicle manufacturer.



The Scan Tool does not perform the OBID monitor check, but retrieves results from the most recently performed tests from the on-board computer's memory. You may retrieve OBID monitor check results for only one test at any given time.

1. From the System Test menu, select **OBID Monitor Check**, then press **ENTER** ↵.
2. A "One moment please. . ." message displays, followed by the Select Test screen. (Refer to the vehicle's service repair manual for information related to non-continuous tests.)

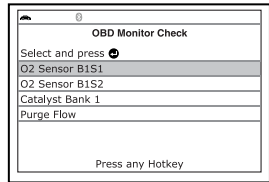

*If OBID monitor check data is not presently stored in the vehicle's computer, an advisory message displays. Press **M** to return to the Main Menu.*



*If OBID monitor checks are not supported by the vehicle under test, an advisory message displays. Press **M** to return to the Main Menu.*

3. Select the desired test, then press **ENTER** ↵ to display the test results. The display shows the following information:

- **Test ID** number
- **Module ID** number
- **Component ID** number

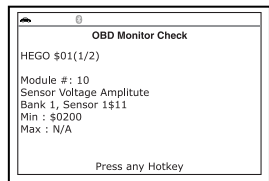

Additional Tests

PERFORMING SERVICE RESETS

- **Min** or **Max** test limit (Only one test limit, either **Min** or **Max**, is shown for any given test.)
- **Test Value** and status



Status is calculated by the Scan Tool by comparing the **Test Value** against the displayed test limit (either **Min** or **Max**). Status is shown as either **Low**, **High** or **OK**.

4. When you have finished viewing the retrieved test data, select **Back** on the Select Test screen, then press **ENTER** to return to the System Test menu; or, press **M** to return to the Main Menu.

EVAP Check

The **EVAP Check** function lets you initiate a leak test for the vehicle's EVAP system.

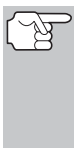

The Scan Tool does not perform the leak test, but signals to vehicle's on-board computer to initiate the test. The vehicle manufacturer determines the criteria and method for stopping the test once it has been started. **BEFORE** using the **EVAP Check** function, refer to the vehicle's service repair manual to determine the procedures necessary to stop the test.

1. From the System Test menu, select **EVAP Check**, then press **ENTER** .
2. A "One moment please..." message displays.
3. When the EVAP leak test has been initiated by the vehicle's on-board computer, a confirmation message displays. Select **Back**, then press **ENTER** to return to the System Test menu; or, press **M** to return to the Main Menu.

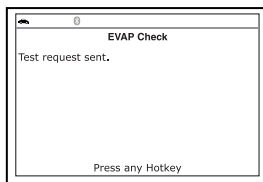

Some vehicle manufacturers do not allow scan tools or other external devices to control vehicle systems. If the **EVAP Check** is not supported by the vehicle under test, an advisory message displays. Press **M** to return to the Main Menu.

PERFORMING SERVICE RESETS

The **Service Reset** function offers up to five options for performing service reset procedures; **Oil Reset**, **Battery Reset**, **Steering Angle Sensor Calibration**, **EPB Reset** and **ABS Bleeding**.

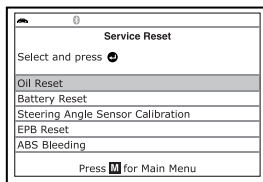



Resetting the Oil Maintenance Light

1. While linked to the vehicle, press **M**.

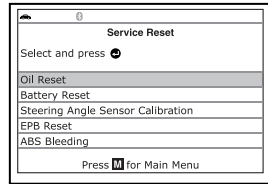
- The Main Menu displays.
2. Select **Service Reset**, then press **ENTER**  to continue.



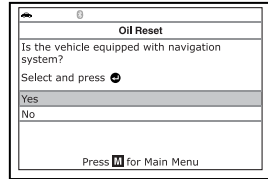

- The Service Reset screen displays.
3. Select **Oil Reset**, then press **ENTER** .

- The Oil Reset screen displays.
- If the vehicle under test is equipped with a navigation system, select **Yes**, then press **ENTER**  to continue.
- If the vehicle under test is not equipped with a navigation system, select **No**, then press **ENTER**  to continue.



*If the Scan Tool cannot reset the Oil Maintenance Light, an "instructional" dialog displays, showing the manual procedures for resetting the indicator light. When finished viewing the instructions, press **M** to return to the Main Menu.*

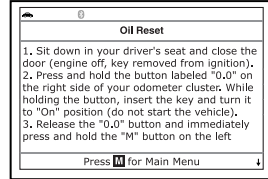

4. The Reset Oil Maintenance Indicator screen displays.

- If you do not wish to proceed with the reset process, select **No**, then press **ENTER**  to return to the System Menu.
- If you wish to proceed with the reset process, select **Yes**, then press **ENTER**  to continue.

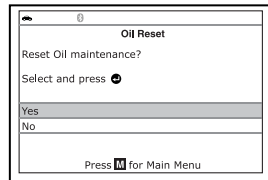

5. When the reset process has completed, a confirmation message displays. Press **M** to return to the Main Menu.



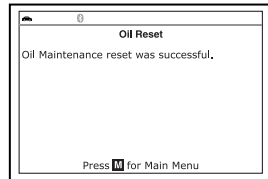

- If the oil reset was not successful, an advisory message displays.
- To perform the oil reset by procedure, select **Yes**, then press **ENTER** . An "instructional" message displays, showing the manual procedures for resetting the indicator light.
- If you do not wish to perform the oil reset by procedure, select **No**, then press **ENTER**  to return to the Main Menu.



Battery Reset

You can use the Scan Tool to view the procedures for resetting the battery monitor system following battery replacement or perform battery reset OBD service (for BMW, Ford and Volvo models only).

To view battery reset procedures:

1. While linked to a vehicle, press **M**.
 - The Main Menu displays.
2. Select **Battery Reset**, then press **ENTER** .
3. Select **Battery Reset Procedures**, then press **ENTER** .

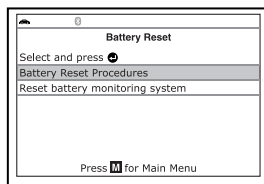

*If battery reset procedures are not available for your vehicle, an advisory message shows. Press **M** to return to the Main Menu.*

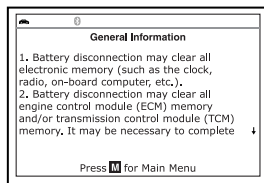

4. Select the procedure you wish to view, then press **ENTER** .
5. When you have finished viewing the retrieved information, press **M** to return to the Main Menu. Repeat steps 2 through 4 to view additional procedures.





To perform battery reset OBD service:

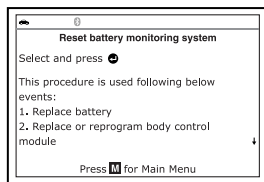

*The **Battery Reset OBD Service** option is available for BMW, Ford and Volvo vehicles only.*

1. While linked to a vehicle, press **M**.
 - The Main Menu displays.
 2. Select **Battery Reset**, then press **ENTER** .
 3. Select **Battery Reset OBD Service**, then press **ENTER** .
- An “instructional” message displays.



4. Follow the instructions provided to prepare the vehicle for battery reset OBd service. When all necessary procedures have been performed, select **Next**, then press **ENTER** .
 - A “Live Data” screen displays, if applicable.
5. Select **Next**, then press **ENTER** .
 - A “One moment please...” message displays while battery reset is in process.
6. If the battery reset process is successful, a “Reset Complete” message displays. Press **M** to return to the Main Menu.
 - If the battery reset process is not successful, a “Reset Fail” message displays. Press **M** to return to the Main Menu.

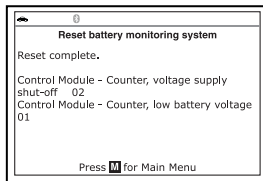



Steering Angle Sensor (SAS) Calibration

The **Steering Angle Sensor Calibration** function is available for BMW, Chrysler, Ford, GM, Hyundai, Nissan, Toyota, Volkswagen and Volvo vehicles only. Calibration procedures vary between vehicle makes and models.



*If an error occurs while performing calibration procedures, an “advisory” message displays. Press **M** to return to the Main Menu.*

1. Select **Steering Angle Sensor Calibration** in the Service Reset menu, then press **ENTER** .
 - For some vehicles, a submenu displays. Select the desired option, then press **ENTER** . Proceed to step 2.



*If SAS calibration is not supported by the vehicle under test, an “advisory” message displays. Press **M** to return to the Main Menu.*

2. A “One moment” message displays, followed by one or more “informational/instructional” screens.

- Perform test procedures as directed. Select **Next** and press **ENTER** , as appropriate, to scroll to the next screen.

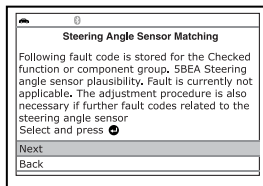

3. For some vehicles, “status” screens display as each phase of the calibration procedure is successfully completed. Select **Next** and press **ENTER** , as appropriate, to scroll to the next screen.

- A “results” screen displays when the calibration procedure has completed.

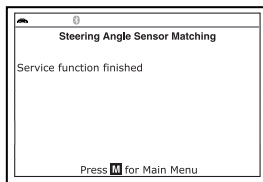

4. Press **M** to return to the Main Menu.

EPB Reset

EPB Reset procedures vary between vehicle makes and models.



*If an error occurs while performing calibration procedures, an “advisory” message displays. Press **M** to return to the Main Menu.*

1. Select **EPB Reset** in the Service Reset menu, then press **ENTER** .

- A “One moment” message displays.
- For some vehicles, a submenu displays. Select the desired option, then press **ENTER** . Proceed to step 2.



*If EPB reset is not supported by the vehicle under test, an “advisory” message displays. Press **M** to return to the Main Menu.*

2. One or more “informational/ instructional” screens display.

- Perform test procedures as directed. Select **Next** and press **ENTER** , as appropriate, to scroll to the next screen.

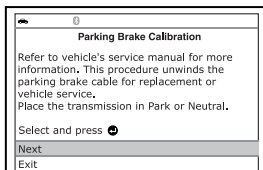

3. For some vehicles, “status” screens display as each phase of the calibration procedure is successfully completed. Select **Next** and press **ENTER** , as appropriate, to scroll to the next screen.

- A “One moment” message displays while the procedure is in process.
- A “results” screen displays when the calibration procedure has completed.



*If the procedure is stopped due to a communication error, an “advisory” message displays. Press **M** to return to the Main Menu.*

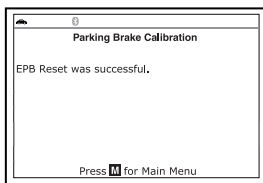

4. Press **M** to return to the Main Menu.

ABS Bleeding

The **ABS Bleeding** function is available for Chrysler, GM, Hyundai/Kia, Mazda and Toyota vehicles only. Procedures vary between vehicle makes and models.



*If an error occurs while performing ABS bleeding procedures, an “advisory” message displays. Select **Exit** or **Back** and press **ENTER** , as necessary, to return to the Service Reset menu.*

1. Select **ABS Bleeding** in the Service Reset menu, then press **ENTER** .
 - A “One moment” message may display.
 - A submenu displays. Select the desired option, then press **ENTER** . Proceed to step 2.
2. One or more “informational/ instructional” screens display.
 - Perform test procedures as directed. Select **Next** or **Continue** and press **ENTER** , as appropriate, to scroll to the next screen.
3. For some vehicles, “status” screens display as each phase of the calibration procedure is successfully completed. Select **Next** or **Continue** and press **ENTER** , as appropriate, to scroll to the next screen.
 - A “results” screen displays when the procedure has completed.

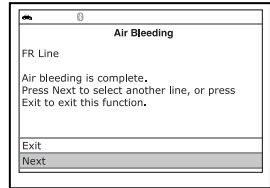
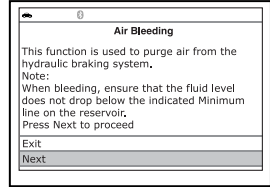

*If the procedure is stopped due to a communication error, an “advisory” message displays. Select **Exit** or **Back** and press **ENTER** , as necessary, to return to the Service Reset menu.*

4. Select **Exit** or **Back** and press **ENTER** , as necessary, to return to the Service Reset menu.

PERFORMING A SERVICE CHECK

The **Service Check** function lets you check the current oil level and oil life.



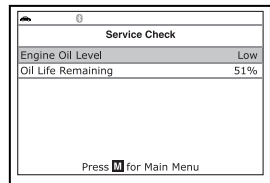



1. While linked to the vehicle, press **M**.
 - The Main Menu displays.
2. Select **Service Check**, then press **ENTER** .
 - The Service Check screen displays.
 - The screen shows the current **Engine Oil Level** and **Oil Life Remaining**.
3. When you have finished viewing the information, press **M** to return to the Main Menu.

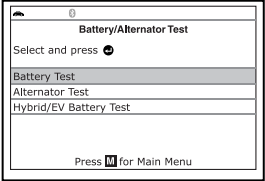

BATTERY/ALTERNATOR TEST

The Scan Tool can perform a check of the vehicle's battery and alternator system to ensure the system is operating within acceptable limits. You can perform a battery check only, or an alternator system (battery and alternator) check.

To perform a battery check ONLY:

1. Press **M** and release.
 - The Main Menu displays.
 2. Select **Battery/Alternator Test**, then press **ENTER** 
 - The Battery/Alternator Test Menu displays.
- 
3. Select **Battery Test**, then press **ENTER** 
 - An "instructional" message displays, showing the procedures to prepare the vehicle for the battery check.
 4. Prepare the vehicle for the battery check:
 - Turn the engine off.
 - Place the transmission in PARK or NEUTRAL, and set the parking brake.
 - Make a visual check of the battery's condition. If the battery terminals are corroded or other damage is present, clean or replace the battery as appropriate.
 - For "unsealed" batteries, make sure the water level in each cell is above the battery plates.
 - Turn the ignition on. **DO NOT** start the engine.
 5. Press **ENTER**  to begin the battery check.
 -  *If the engine is running, an advisory message shows. Turn the engine off, then turn the ignition on. **DO NOT** start the engine. Press **ENTER**  to continue.*
 - An "instructional" message shows.
 6. Turn the vehicle's headlights on, then press **ENTER**  to continue.
 - A "countdown" message shows on the Scan Tool's display while the battery check is in process.
 - If battery voltage is *less than* 12.1 volts, an advisory message shows. Press **M** to return to the Main Menu. Turn the ignition off and disconnect the Scan Tool from the vehicle. Fully charge the battery, then repeat the battery check.
 - If battery voltage is *greater than* 12.1 volts, an "instructional" message shows.

- Turn the vehicle's headlights off, then press **ENTER**  to continue.
 - An "instructional" message shows.
- Start the vehicle's engine. Allow the engine to run for several seconds, then turn the engine off. Repeat for a total of three "start/stop" cycles.



*If the Scan Tool did not detect "cranking status" for the vehicle's engine, an advisory message shows. Press **ENTER**  to repeat the battery check, or, press **M** to return to the Main Menu.*

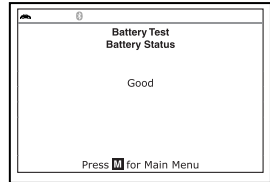

- When the battery check is complete, a results screen displays the battery status. The System Status LEDs provide a PASS/FAIL indication, as follows:

- Green = Good
- Yellow = Normal
- Red = Warning/Bad



- Press **M** to return to the Main Menu.

To perform a charging system check:

- Press **M** and release.
 - The Main Menu displays.
- Select **Battery/Alternator Test**, then press **ENTER** .
 - The Battery/Alternator Test Menu displays.
- Select **Alternator Test**, then press **ENTER** .
 - An "instructional" message shows.
- Start and warm the engine to normal operating temperature. Turn on the headlights. Press **ENTER**  to continue.
 - An "instructional" message shows.
- Press the accelerator pedal to raise engine speed to 2000 RPM, and maintain the engine speed.
 - When engine speed is within the required range, the alternator test begins. A progress screen shows.
 - When the "countdown" timer expires, an "instructional" message shows.
- Turn the vehicle's headlights off, and return the engine to idle speed.
 - A "One moment please..." message displays while the test results are retrieved.

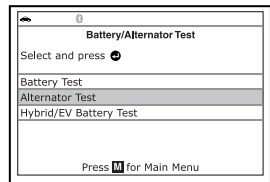

- When the alternator check is complete, a results screen shows charging system voltage and indicates whether or not the charging system is within acceptable limits. The System Status LEDs provide a PASS/FAIL indication, as follows:
 - Green = System within limits
 - Yellow = Over charging or under charging
 - Red = Excessive over charging or under charging
 - If the alternator voltage is less than 9 V, the red, yellow and green SYSTEM STATUS LEDs will flash on and off.
- Press **M** to return to the Main Menu.

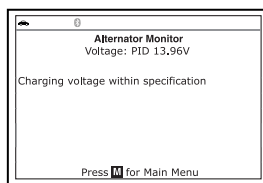
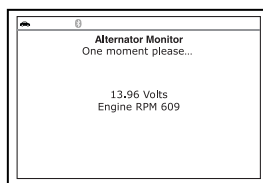

To perform a hybrid/EV battery system check:

- Press **M** and release.
 - The Main Menu displays.
- Select **Battery/Alternator Test**, then press **ENTER** ↵.
 - The Battery/Alternator Test Menu displays.
- Select **Hybrid/EV Battery Test**, then press **ENTER** ↵.
 - If the vehicle supports battery Live Data, the Battery Live Data screen displays. The screen shows the state of charge, battery pack voltage and sum of cell voltages for the battery pack.
 - If the vehicle supports battery cell display, a graphic display of the current state of charge for all cells in the battery pack displays.
- When you have finished viewing the retrieved information, press **M** to return to the Main Menu.

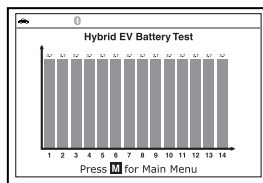

VIEWING DRIVE CYCLE PROCEDURES

A Drive Cycle for a Monitor requires that the vehicle is driven in such a way that all the required "Enabling Criteria" for the Monitor to run and complete its diagnostic testing are met. You can use the Scan Tool to view the Drive Cycle procedures for a selected Monitor.

- While linked to a vehicle, press **M**.
 - The Main Menu displays.

2. Select **Drive Cycle Procedures**, then press **ENTER** .

- A “One moment please...” message displays while the Scan Tool retrieves Monitor status from the vehicle’s computer.

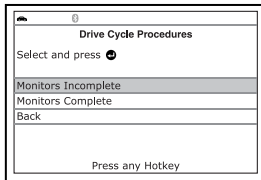

3. When Monitor status has been retrieved, the Drive Cycle Procedures menu displays. Depending on Monitor status, you can view Drive Cycle procedures for **Monitors Incomplete** or **Monitors Complete**.





*If Drive Cycle Procedures are not available for the vehicle, an advisory message shows on the Scan Tool's display. Select **Back**, then press **ENTER**  to return to the Main Menu.*

4. Select **Monitors Incomplete** or **Monitors Complete**, as desired, then press **ENTER** .

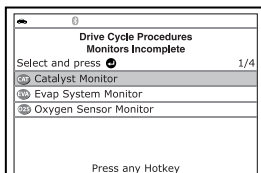
- A list of the available Monitors for the selected status displays.



*If no Monitors for the selected status are detected, an advisory message shows. Select **Back**, then press **ENTER**  to return to the Main Menu.*

5. Select the Monitor for which you wish to view Trip Cycle Procedures, then press **ENTER** .

- A “One moment please...” message displays while the Scan Tool retrieves the requested Trip Cycle Procedure. The Trip Cycle Procedures screen for the Monitor displays when the procedure has been retrieved.



*If a Trip Cycle Procedure for the selected Monitor is not available, an advisory message shows. Select **Back**, then press **ENTER**  to return to the Main Menu.*

6. The Drive Cycle Procedure screen shows the specific set of operating procedures that ensure the vehicle is driven in such a way that all the required “Enabling Criteria” for the Monitor to run and complete its diagnostic testing are met.

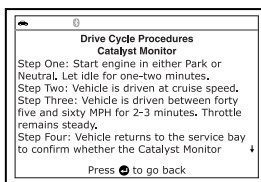

7. When you are finished viewing the Drive Cycle Procedures, press **ENTER**  to return to the Drive Cycle Procedures menu, or, press **M** to return to the Main Menu.

USING THE DLC LOCATOR

1. Select **DLC Locator** in the **Main Menu**, then press **ENTER** ↵.
 - The Select Vehicle Model Year screen displays.
2. Select the desired vehicle model year, then press **ENTER** ↵.
 - The Select Vehicle Manufacturer screen displays.
3. Select the desired vehicle manufacturer, then press **ENTER** ↵.
 - The Select Vehicle Model screen displays.
4. Select the desired model, then press **ENTER** ↵.
 - The DLC Location screen for the selected vehicle displays.
 - The DLC Location screen shows the selected vehicle make and model, a description of the DLC location and whether the DLC is “covered” or “uncovered,” and includes a picture of the DLC location.

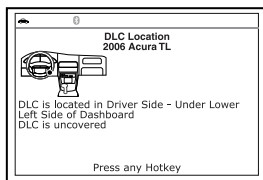

5. When you have finished viewing the DLC location, press any hotkey to exit the DLC Locator.

VIEWING VEHICLE INFORMATION

The **Vehicle Information** function offers three options for retrieving reference information for the vehicle under test; **Vehicle ID**, **Available Modules** and **IPT** (In-Use Performance Tracking).

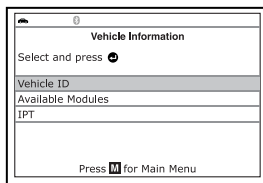

Retrieving Vehicle ID Information





The Vehicle ID function is applicable to model year 2000 and newer OBD2-compliant vehicles.

The Scan Tool can retrieve a list of information (provided by the vehicle manufacturer), unique to the vehicle under test, from the vehicle's on-board computer. This information may include:

- The vehicle's VIN number
- The control module identification number
- The vehicle's calibration ID(s). These IDs uniquely identify the software version(s) for the vehicle's control module(s).
- The Vehicle's Calibration Verification Number(s) (CVNs) required by ODB2 regulations. CVNs are used to determine if emission-related calibrations for the vehicle under test have been changed. One or more CVNs may be returned by the vehicle's computer.

1. With the Scan Tool in OBD2 mode, press **M**.
 - The Main Menu displays.

2. Select **Vehicle Information**, then press **ENTER** 
 - The Vehicle Information menu displays.
3. Select **Vehicle ID**, then press **ENTER** .



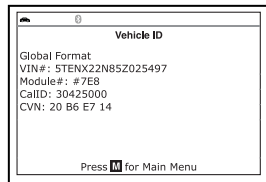

*The first time the **Vehicle ID** function is used, it may take several minutes to retrieve the information from the vehicle's computer.*

4. When the retrieval process is completed, the vehicle ID information displays.
5. When you have finished viewing the retrieved vehicle ID information, press the **M** button to return to the Main Menu.



Viewing Available Modules

The Scan Tool can retrieve a list of modules supported by the vehicle under test.

1. With the Scan Tool in OBD2 mode, press and release **M**.
 - The Main Menu displays.
2. Select **Vehicle Information**, then press **ENTER** 
 - The Vehicle Information menu displays.
3. Select **Available Modules**, then press **ENTER** .

4. When the retrieval process is completed, a complete list of modules supported by the vehicle under test displays.
5. When you have finished viewing the list of available modules, press **M** to return to the Main Menu.

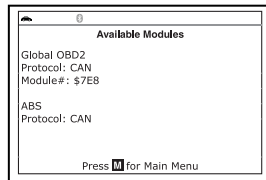

Viewing In-use Performance Tracking (IPT)

The Scan Tool can retrieve In-use Performance Tracking (IPT) statistics for monitors supported by the vehicle under test. Two values are returned for each monitor; the number of times that all conditions necessary for a specific monitor to detect a malfunction have been encountered (XXXCOND), and the number of times that the vehicle has been operated under the specific conditions for the monitor (XXXCOMP). Statistics are also provided for the number of times the vehicle has been operated in OBD monitoring conditions (OBDCOND), and the number of times the vehicle's engine has been started (IGNCNTR).

1. With the Scan Tool in OBD2 mode, press and release **M**.
 - The Main Menu displays.

2. Select **Vehicle Information**, then press the **ENTER**  button.
 - The Vehicle Information menu displays.

3. Select **IPT**, then press **ENTER** .

4. When the retrieval process is completed, the In-use Performance Tracking statistics for the vehicle under test display.

- If In-use Performance Tracking is not available for your vehicle, an advisory message shows on the Scan Tool's display. Press **M** to return to the Main Menu.

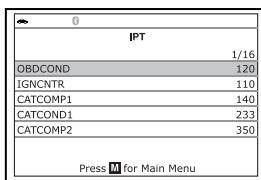

	1/16
OBDCOND	120
IGCNTR	110
CATCOMP1	140
CATCON1	233
CATCOMP2	350

Press **M** for Main Menu

5. When you have finished viewing the statistics, press **M** to return to the Main Menu.

VIEWING THE FIRMWARE VERSION

1. Select **Firmware Version** in the Main Menu, then press **ENTER** .

- The Firmware Version screen displays for four seconds.
- The screen shows the Scan Tool's current firmware version, bootloader version and database version.

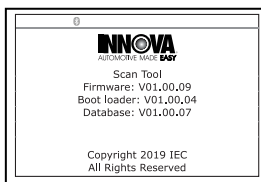

2. The display returns to the Main Menu.

THE TOOL LIBRARY

The Tool Library contains valuable reference information for the Scan Tool. The following functions are available:

- **Tool Icons** – Shows the full names for the **I/M MONITOR STATUS** icons shown and descriptions of informational icons on the Scan Tool's display.
- **DTC Library** – Provides access to libraries of OBD1 and OBD2 DTC definitions.
- **LED Meaning** – Provides descriptions of the meaning of the Scan Tool **SYSTEM STATUS** LEDs.

1. While linked to the vehicle, press **M**.

- The Main Menu displays.

2. Select **Tool Library**, then press **ENTER** .

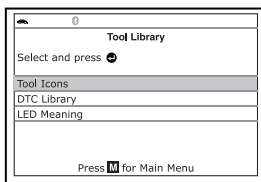

- The Tool Library menu displays.



Viewing Tool Icon Descriptions

The **I/M MONITOR STATUS** icons on the Scan Tool's LCD display provide an indication of the "Completed / Not Complete" status for all I/M Monitors supported by the vehicle under test. The **Tool Icons** function displays the full name for each Monitor icon, as well as descriptions of the meanings of other informational icons shown on the Scan Tool's display.

1. From the Tool Library menu, select **Tool Icons**, then press **ENTER** .

- The Tool Icons screen displays.
- The screen shows a list of the 15 Monitor icons, along with the full name for each icon, as well as descriptions of the meanings of other informational icons. Use the **UP**  and **DOWN**  buttons, as necessary, to scroll the list.

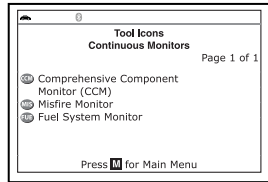



2. When you have finished viewing the tool icon descriptions, press **M** to return to the Main Menu.

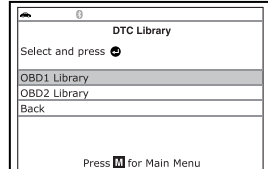

Using the DTC Library (OBD1)

1. From the Tool Library menu, select **DTC Library**, then press **ENTER** .



- The Select Library screen displays.
2. Select **OBD1 Library**, then press **ENTER** .
- The Select Manufacturer screen displays.



3. Select the desired vehicle manufacturer, then press **ENTER** .

- A confirmation message shows.
 - If the correct manufacturer is not shown, select **No**, then press **ENTER**  to return to the list of vehicle manufacturers.
 - If the correct manufacturer is shown, select **Yes**, then press **ENTER** .

4. The Enter DTC screen displays.

- The screen shows the code "001," with the first "0" highlighted. Press **UP**  and **DOWN** , as necessary, to scroll to the first digit of the DTC, then press **DTC/FF**.
- The selected character displays solid, and the next character is highlighted.

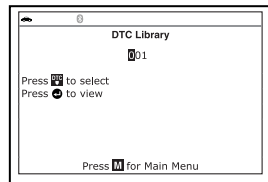

- Select the remaining digits in the DTC in the same way. When you have selected all the DTC digits, press **ENTER** \leftarrow to view the DTC definition.
- When you have finished viewing the DTC definition, select **Back**, then press **ENTER** \leftarrow to return to the Enter DTC screen and enter additional DTCs; or, press **M** to return to the Main Menu.

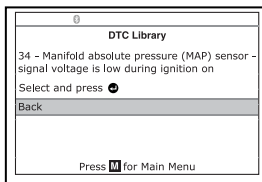

If a definition for the DTC you entered is not available, an advisory message shows. Select **Back**, then press **ENTER** \leftarrow to return to the Enter DTC screen and enter additional DTCs; or, press **M** to return to the Main Menu.

Using the DTC Library (OBD2)

- From the Tool Library menu, select **DTC Library**, then press **ENTER** \leftarrow .
 - The Select Library screen displays.
- Select **OBD2 Library**, then press **ENTER** \leftarrow .
 - The Select Manufacturer screen displays.
- Select the desired vehicle manufacturer, then press **ENTER** \leftarrow .
 - The Enter DTC screen displays. The screen shows the code "P0001," with the "P" highlighted.
- Use the **UP** \blacktriangle and **DOWN** \blacktriangledown buttons, as necessary, to scroll to the desired DTC type (P=Powertrain, U=Network, B=Body, C=Chassis), then press **DTC/FF**.
 - The selected character displays solid, and the next character is highlighted.
- Select the remaining digits in the DTC in the same way. When you have selected all the DTC digits, press **ENTER** \leftarrow to view the DTC definition.
- When you have finished viewing the DTC definition, highlight **Back**, then press **ENTER** \leftarrow to return to the Enter DTC screen and enter additional DTCs; or, press **M** to return to the Main Menu.

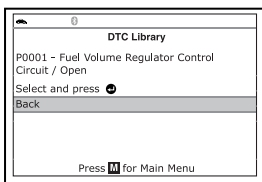
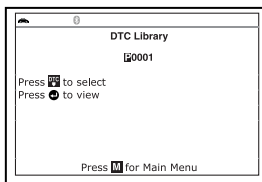
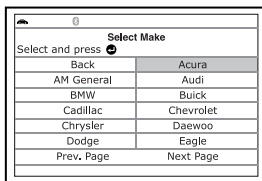
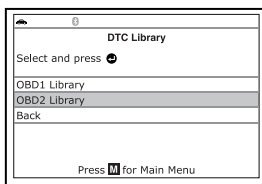



If a definition for the DTC you entered is not available, an advisory message shows. Highlight **Back**, then press **ENTER** to return to the Enter DTC screen and enter additional DTCs; or, press **M** to return to the Main Menu.

Viewing LED Meanings

The **SYSTEM STATUS** LEDs on the Scan Tool provide a visual indication of the I/M Readiness status of the vehicle under test. The **LED Meanings** function provides a description of the meanings of the green, yellow and red **SYSTEM STATUS** LEDs.

1. From the Tool Library menu, select **LED Meaning**, then press **ENTER** .
 - The LED Meaning screen displays.
 - The screen provides a description of the meanings of the green, yellow and red **SYSTEM STATUS** LEDs.
2. When you have finished viewing the LED meanings, press **M** to return to the Main Menu.

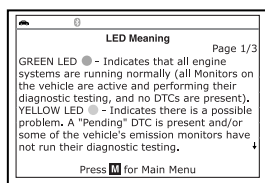

ADJUSTMENTS AND SETTINGS

The Scan Tool lets you make several adjustments and settings to configure the Scan Tool to your particular needs. The following adjustments and settings are available.

- **Adjust Brightness:** Adjusts the brightness of the display screen.
- **Audible Tone:** Turns the Scan Tool's audible tone "on" and "off." When turned "on," a tone sounds each time a button is pressed.
- **Footer Messages:** Turns the navigational "footers" at the bottom of most display screens "on" and "off."
- **Hotkey Legend:** Shows functional descriptions for the Scan Tool's hotkeys.
- **Language Selection:** Sets the display language for the Scan Tool to English, French or Spanish.
- **Unit of Measurement:** Sets the Unit of Measurement for the Scan Tool's display to USA or metric.

To enter the Tool Settings mode:

1. While linked to the vehicle, press and release the **M** button.
 - The Main Menu displays.
2. Select **Tool Settings**, then press **ENTER** .

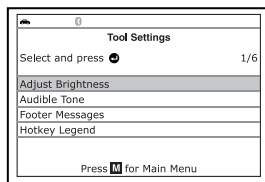

- The Tool Setting menu displays.
3. Make adjustments and settings as follows.

Adjusting Display Brightness

1. Select **Adjust Brightness** in the Tool Settings menu, then press **ENTER** ↵.
 - The Adjust Brightness screen displays.
 - The **Adjust Brightness** field shows the current brightness setting, from 1 to 5.
2. Press **UP** ▲ and **DOWN** ▼ to make the display lighter or darker, then press **ENTER** ↵ to save your changes.

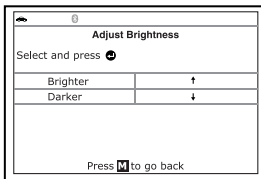

To return to the Tool Settings menu without making changes, press **M**.

Enabling/Disabling the Audible Tone

1. Select **Audible Tone** in the Tool Settings menu, then press **ENTER** ↵.
 - The Audible Tone screen displays.
2. Select **On** or **Off** as desired, then press **ENTER** ↵ to save your changes.

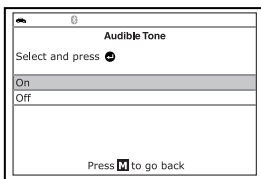

To return to the Tool Settings menu without making changes, press **M**.

Enabling/Disabling Navigational Footers

1. Select **Footer Messages** in the Tool Settings menu, then press **ENTER** ↵.
 - The Footer Messages screen displays.
2. Select **On** or **Off** as desired, then press **ENTER** ↵ to save your changes.

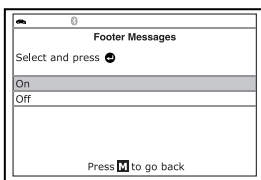

To return to the Tool Settings menu without making changes, press **M**.

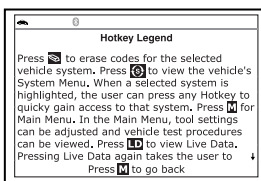

Viewing the Hotkey Legend

1. Select **Hotkey Legend** in the Tool Settings menu, then press **ENTER** ↵.
 - The Hotkey Legend screen displays.
 - The screen shows a functional description of each of the Scan Tool's hotkeys.



- When you have finished viewing the Hotkey Legend, press **ENTER**  to return to the Tool Settings menu.

Selecting the Display Language

- Select **Language Selection** in the Tool Settings menu, then press **ENTER** .
 - The Language Selection screen displays.
- Select the desired display language, then press **ENTER**  to save your changes.

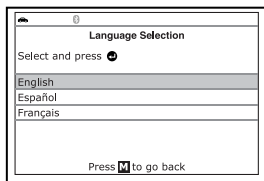

To return to the Tool Settings menu without making changes, press **M**.

Setting the Unit of Measurement

- Select **Unit of Measurement** in the Tool Settings menu, then press **ENTER** .
 - The Unit of Measurement screen displays.
- Select the desired unit of measurement, then choose **Save** to save your changes.

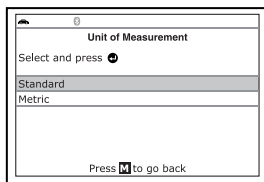

To return to the Tool Settings menu without making changes, press **M**.

Exiting the MENU Mode

- Press **M** to return to the Main Menu.

When you retrieve DTCs from a vehicle, the data is saved to the Scan Tool's memory.



Each time you retrieve DTCs, existing data in the Scan Tool's memory is overwritten with the new data.

VIEWING DATA IN MEMORY

When you turn the Scan Tool on while NOT connected to a vehicle, and data is currently saved in the Scan Tool's memory, the Scan Tool enters Memory mode. You can view DTCs and Live Data stored in the Scan Tool's memory.

1. With the Scan Tool NOT connected to a vehicle, press and release the **POWER/LINK**  button to turn the Scan Tool on.
 - If the Scan Tool's batteries are low, a warning message displays. Replace the batteries before continuing.

2. If more than one vehicle is stored in the Scan Tool's memory, the Vehicle Selection menu displays. Select the desired vehicle, then press **ENTER** .



*If there are no vehicles currently stored in the Scan Tool, an advisory message displays. Press **M** to return to the Main Menu.*

- The Memory System Menu displays.
3. Select the DTCs you wish to view, then press **ENTER** .

- The Scan Tool displays the "priority" DTC.



If there are no DTCs currently stored in the Scan Tool's memory, an advisory message shows.

- Press **DTC/FF** to scroll through all stored DTCs, and to view Freeze Frame data for the priority DTC.
- When all DTCs have been displayed and **DTC/FF** is pressed, the Scan Tool displays the first enhanced DTC stored in memory. Press **DTC/FF** to scroll through all stored enhanced DTCs.

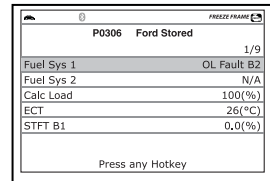
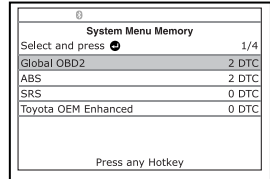
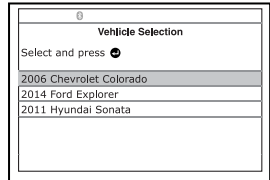

4. When you have finished viewing data in the Scan Tool's memory, press and release **POWER/LINK**  to turn the Scan Tool off.

LIMITED ONE YEAR WARRANTY

The Manufacturer warrants to the original purchaser that this unit is free of defects in materials and workmanship under normal use and maintenance for a period of one (1) year from the date of original purchase.

If the unit fails within the one (1) year period, it will be repaired or replaced, at the Manufacturer's option, at no charge, when returned prepaid to the Service Center with Proof of Purchase. The sales receipt may be used for this purpose. Installation labor is not covered under this warranty. All replacement parts, whether new or remanufactured, assume as their warranty period only the remaining time of this warranty.

This warranty does not apply to damage caused by improper use, accident, abuse, improper voltage, service, fire, flood, lightning, or other acts of God, or if the product was altered or repaired by anyone other than the Manufacturer's Service Center.

The Manufacturer, under no circumstances shall be liable for any consequential damages for breach of any written warranty of this unit. This warranty gives you specific legal rights, and you may also have rights, which vary from state to state. This manual is copyrighted with all rights reserved. No portion of this document may be copied or reproduced by any means without the express written permission of the Manufacturer. **THIS WARRANTY IS NOT TRANSFERABLE.** For service, send via U.P.S. (if possible) prepaid to Manufacturer. Allow 3-4 weeks for service/repair.

SERVICE PROCEDURES

If you have any questions, require technical support or information on UPDATES and OPTIONAL ACCESSORIES, please contact your local store, distributor or the Service Center.

USA & Canada:

(800) 544-4124 (6:00 AM-6:00 PM PST, Monday through Saturday)

All others: (714) 241-6802 (6:00 AM-6:00 PM PST, Monday through Saturday)

FAX: (714) 241-3979 (24 hr.)

Web: www.innova.com



TECHNICAL ASSISTANCE
1 800 544 4124
HABLAMOS ESPAÑOL • SERVICE IN THE USA
ASE CERTIFIED TECHNICIANS

INNOVA.COM

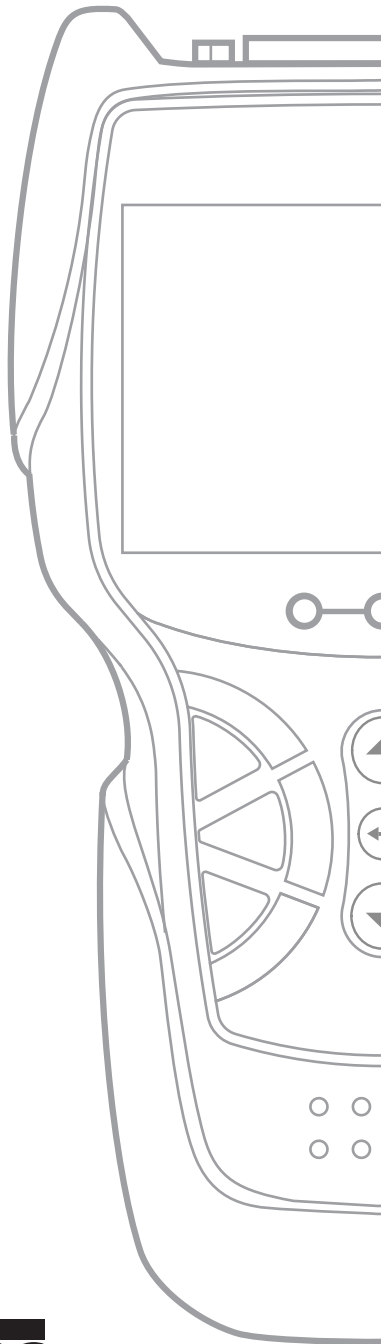

INNOVA

Innova Electronics Corp.
17352 Von Karman Ave.
Irvine, CA 92614

