

CarScan[®] Scan Tool



OWNER'S MANUAL

RepairSolutions 2

Table of Contents

ABOUT THE SCAN TOOL	
SAFETY FIRST!	1
CONTROLS AND INDICATORS	2
DISPLAY FUNCTIONS	3
INITIAL ADJUSTMENTS	5
USING THE SCAN TOOL	
CODE RETRIEVAL PROCEDURE	6
THE SYSTEM MENU	10
VIEWING OEM ENHANCED DTCs (except Ford/Mazda).....	11
VIEWING OEM ENHANCED DTCs (Ford/Mazda only)	12
VIEWING ABS DTCs	13
ERASING DIAGNOSTIC TROUBLE CODES (DTCs)	15
ABOUT REPAIRSOLUTIONS 2®	16
CONNECTING TO BLUETOOTH / WIFI	17
LIVE DATA MODE	
VIEWING LIVE DATA	18
CUSTOMIZING LIVE DATA (PIDs)	19
ADDITIONAL FUNCTIONS	
SYSTEM TEST MENU	21
VIEWING VEHICLE INFORMATION	24
BATTERY/ALTERNATOR TEST	26
VIEWING THE FIRMWARE VERSION	28
THE TOOL LIBRARY	28
ADJUSTMENTS AND SETTINGS	30
WARRANTY AND SERVICING	
LIMITED ONE YEAR WARRANTY	33
SERVICE PROCEDURES	33

SAFETY FIRST!

This manual describes common test procedures used by experienced service technicians. Many test procedures require precautions to avoid accidents that can result in personal injury, and/or damage to your vehicle or test equipment. Always read your vehicle's service manual and follow its safety precautions before and during any test or service procedure. **ALWAYS** observe the following general safety precautions:



When an engine is running, it produces carbon monoxide, a toxic and poisonous gas. To prevent serious injury or death from carbon monoxide poisoning, operate the vehicle **ONLY** in a **well-ventilated** area.



To protect your eyes from propelled objects as well as hot or caustic liquids, **always** wear **approved** safety eye protection.



When an engine is running, many parts (such as the coolant fan, pulleys, fan belt etc.) turn at high speed. To avoid serious injury, always be aware of moving parts. Keep a safe distance from these parts as well as other potentially moving objects.



Engine parts become very hot when the engine is running. To prevent severe burns, avoid contact with hot engine parts.



Before starting an engine for testing or trouble-shooting, make sure the parking brake is engaged. Put the transmission in **park** (for automatic transmission) or **neutral** (for manual transmission). Block the drive wheels with suitable blocks.



Connecting or disconnecting test equipment when the ignition is **ON** can damage test equipment and the vehicle's electronic components. Turn the ignition **OFF** before connecting the Code Reader to or disconnecting the Code Reader from the vehicle's Data Link Connector (DLC).



To prevent damage to the on-board computer when taking vehicle electrical measurements, always use a digital multimeter with at least 10 MegOhms of impedance.



The vehicle's battery produces highly flammable hydrogen gas. To prevent an explosion, keep all sparks, heated items and open flames away from the battery.



Don't wear loose clothing or jewelry when working on an engine. Loose clothing can become caught in the fan, pulleys, belts, etc. Jewelry is highly conductive, and can cause a severe burn if it makes contact between a power source and ground.

CONTROLS AND INDICATORS

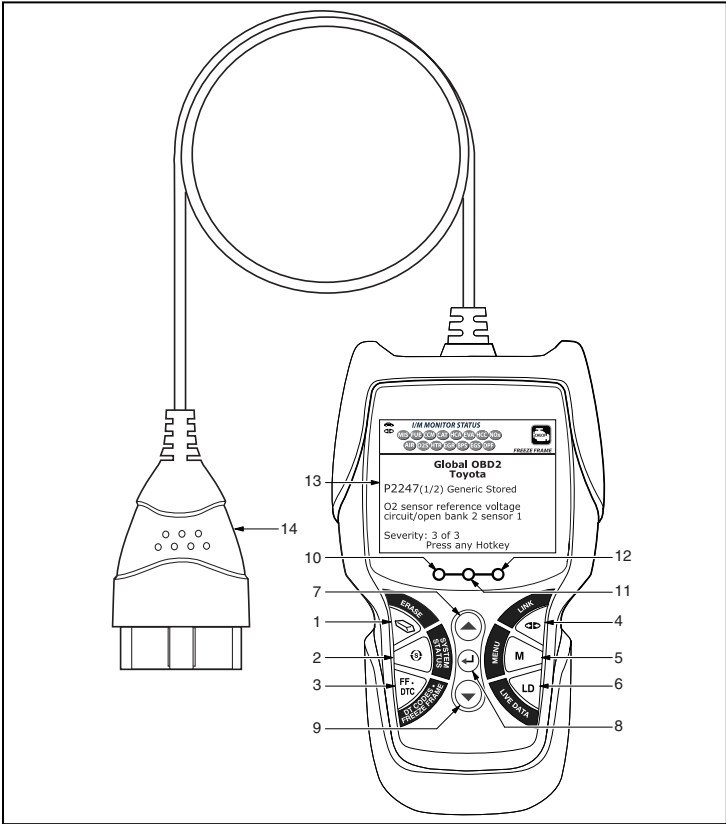

Figure 1. Controls and Indicators

See Figure 1 for the locations of items 1 through 14, below.

1. **ERASE button** - Erases Diagnostic Trouble Codes (DTCs) and "Freeze Frame" data from your vehicle's computer, and resets Monitor status.
2. **SYSTEM MENU button** - When pressed, displays the System Menu.
3. **DTC/FF button** - Displays the DTC View screen and/or scrolls the LCD display to view DTCs and Freeze Frame data.
4. **LINK button** - When connected to a vehicle, links the Scan Tool to the vehicle's PCM.

5. **M (Menu) button** – When pressed, displays the Main Menu.
6. **LD button** – When pressed while linked to a vehicle, places the Scan Tool in Live Data mode.
7. **▲ UP button** – When in MENU mode, scrolls UP through the menu options. When LINKED to a vehicle, scrolls UP through the current display screen to display any additional data.
8. **↵ ENTER button** - When in Menu mode, confirms the selected option or value.
9. **▼ DOWN button** - When in MENU mode, scrolls down through the menu options. When LINKED to a vehicle, scrolls down through the current display screen to display any additional data.
10. **GREEN LED** - Indicates that all engine systems are running normally (all Monitors on the vehicle are active and performing their diagnostic testing, and no DTCs are present).
11. **YELLOW LED** - Indicates there is a possible problem. A “Pending” DTC is present and/or some of the vehicle's emission monitors have not run their diagnostic testing.
12. **RED LED** - Indicates there is a problem in one or more of the vehicle's systems. The red LED is also used to show that DTC(s) are present. DTCs are shown on the Scan Tool's LCD display. In this case, the Malfunction Indicator (“Check Engine”) lamp on the vehicle's instrument panel will light steady on.
13. **Display** - Displays test results, Scan Tool functions and Monitor status information. See DISPLAY FUNCTIONS, below, for details.
14. **CABLE** - Connects the Scan Tool to the vehicle's Data Link Connector (DLC).

DISPLAY FUNCTIONS

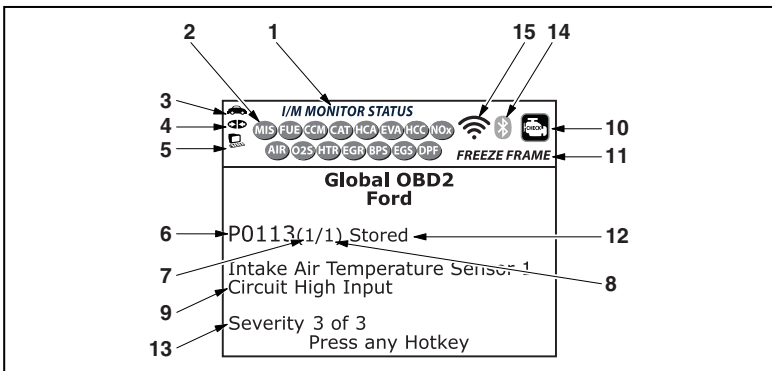





Figure 2. Display Functions

See Figure 2 for the locations of items 1 through 15, below.

1. **I/M MONITOR STATUS field** - Identifies the I/M Monitor status area.

- 2. Monitor icons** - Indicate which Monitors are supported by the vehicle under test, and whether or not the associated Monitor has run its diagnostic testing (Monitor status). A solid green icon indicates the associated Monitor has completed its diagnostic testing. A flashing red icon indicates that the vehicle supports the associated Monitor, but the Monitor has not yet run its diagnostic testing.
- 3.  Vehicle icon** - When visible, indicates that the scan tool is being powered through the vehicle's DLC connector.
- 4.  Link icon** - When visible, indicates the scan tool is communicating with the vehicle's computer.
- 5.  Computer icon** - When visible, indicates the scan tool is linked to a personal computer.
- 6. DTC Display Area** - Displays the Diagnostic Trouble Code (DTC) number. Each fault is assigned a code number that is specific to that fault. The DTC number is color-coded as follows:
 - **RED** - Indicates the currently displayed DTC is a STORED or PERMANENT DTC.
 - **YELLOW** - Indicates the currently displayed DTC is a PENDING DTC.
 - **GREEN** - In cases where no codes are retrieved, a "No DTCs are presently stored in the vehicle's computer" message is shown in green.
- 7. Code Number Sequence** - The scan tool assigns a sequence number to each DTC that is present in the computer's memory, starting with "1." This number indicates which code is currently displayed. Code number "1" is always the highest priority code, and the one for which "Freeze Frame" data has been stored.



If "1" is a "Pending" code, there may or may not be "Freeze Frame" data stored in memory.

- 8. Code Enumerator** - Indicates the total number of codes retrieved from the vehicle's computer.
- 9. Test Data Display Area** - Displays DTC definitions, Freeze Frame data and other pertinent test information messages.
- 10. SYSTEM icon** - Indicates the system with which the code is associated:





MIL icon





ABS icon

- 11. FREEZE FRAME icon** - Indicates that there is Freeze Frame data from "Priority Code" (Code #1) stored in the vehicle's computer memory.
- 12. Code type** - Indicates the type of code being displayed; **Generic Stored, Generic Pending, Generic permanent**, etc.
- 13. Severity** - Indicates the level of severity for the priority code (code number "1"), as follows:

- 1 - Service should be scheduled and repairs made when convenient. This DTC typically has no immediate threat to essential system components in the short term.
- 2 - Repair immediately if drivability issues are present. Threat to essential system components if not repaired as soon as possible.
- 3 - Stop and repair vehicle immediately to prevent interrelated failures. Harmful and damaging to essential system components.
14.  **Bluetooth icon** – Indicates communication status with a compatible Innova mobile application (please visit www.innova.com/apps for more information). A solid blue icon indicates an active Bluetooth connection has been established. A solid grey icon indicates Bluetooth is not connected.
15.  **WiFi icon** – Indicates WiFi communication status. When ON, indicates the scan tool is linked to a WiFi network. When OFF, indicates there is no WiFi connection.

INITIAL ADJUSTMENTS

The first time the unit is connected to a vehicle, you must select the desired display language (English, French or Spanish) and unit of measurement (USA or Metric) as follows:

1. Select the desired display language, then press **ENTER** .
 - The Select Unit screen displays.
2. Select the desired unit of measurement, then press **ENTER** .



After the initial language and unit of measurement selections are performed, these, as well as other settings, can be changed as desired. Proceed to “ADJUSTMENTS AND SETTINGS” on page 29 for further instructions.

CODE RETRIEVAL PROCEDURE

Retrieving and using Diagnostic Trouble Codes (DTCs) for troubleshooting vehicle operation is only one part of an overall diagnostic strategy.

Never replace a part based only on the DTC definition. Each DTC has a set of testing procedures, instructions and flow charts that must be followed to confirm the location of the problem. Always refer to the vehicle's service manual for detailed testing instructions.



Check your vehicle thoroughly before performing any test.



ALWAYS observe safety precautions whenever working on a vehicle.

1. Turn the ignition off.
2. Locate the vehicle's 16-pin Data Link Connector (DLC).



Some DLCs have a plastic cover that must be removed before connecting the Scan Tool.



If the Scan Tool is ON, turn it OFF BEFORE connecting to the DLC.

3. Connect the Scan Tool to the vehicle's DLC. The cable connector is keyed and will only fit one way.

- If you have problems connecting the cable connector to the DLC, rotate the connector 180°.

If you still have problems, check the DLC on the vehicle and on the Scan Tool.

4. Turn the ignition on. **DO NOT** start the engine.
5. When the Scan Tool is properly connected to the vehicle's DLC, the Scan Tool will automatically turn ON.

- If the unit does not power on automatically, it may indicate there is no power present at the vehicle's DLC connector. Check the fuse panel and replace any burned-out fuses.
- If replacing the fuse(s) does not correct the problem, consult your vehicle's repair manual to identify the proper computer (PCM) fuse/circuit, and perform any necessary repairs before proceeding.

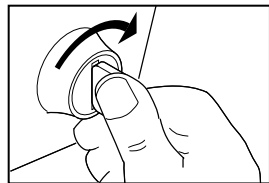
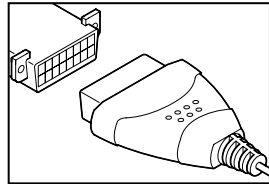
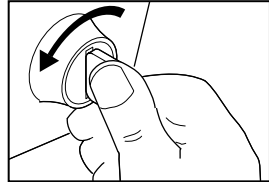

- The Scan Tool automatically starts a check of the vehicle's computer to determine which type of communication protocol it is using. When the Scan Tool identifies the computer's communication protocol, a communication link is established.



A **PROTOCOL** is a set of rules and procedures for regulating data transmission between computers, and between testing equipment and computers. As of this writing, five different types of protocols (ISO 9141, Keyword 2000, J1850 PWM, J1850 VPW and CAN) are in use by vehicle manufacturers.

- If the Scan Tool fails to link to the vehicle's computer, a "Communication Error" message shows.
 - Ensure your vehicle is OBD2 compliant.
 - Verify the connection at the DLC, and verify the ignition is ON.
 - Turn the ignition OFF, wait 5 seconds, then back ON to reset the computer.
 - Press **LINK** to continue.
- If the Scan Tool **cannot** link to the vehicle's computer after three attempts, the message "Contact Technical Support" displays.
 - Press the **SYSTEM MENU** button to return to the System Menu.
 - Turn the ignition off, and disconnect the Scan Tool.
 - Contact Technical Support for assistance.

- If the Scan Tool can decode the Vehicle Identification Number (VIN) for the vehicle under test, the Confirm Vehicle screen displays.

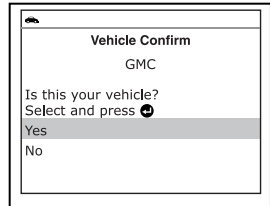

- If the information shown is correct for the vehicle under test, select **Yes**, then press **ENTER** . Proceed to step 10.
- If the information shown is not correct for the vehicle under test, or if you wish to manually select the vehicle, select **No**, then press **ENTER** . Proceed to step 8.
- If the Scan Tool **cannot** decode the Vehicle Identification Number (VIN) for the vehicle under test, the Select Vehicle screen displays. Proceed to step 8.

- When **No** is selected from the Vehicle information screen, the Select Vehicle screen displays. The Select Vehicle screen lists the three most recently tested vehicles.

- To use a previously tested vehicle, select the desired vehicle, then press **ENTER** . Proceed to step 10.

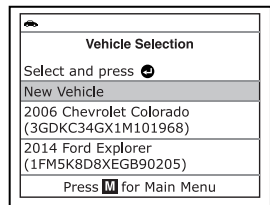

- In OBD2 systems, when an emissions-related engine malfunction occurs that causes a DTC to set, a record or snapshot of engine conditions at the time that the malfunction occurred is also saved in the vehicle's computer memory. The record saved is called Freeze Frame data. Saved engine conditions include, but are not limited to: engine speed, open or closed loop operation, fuel system commands, coolant temperature, calculated load value, fuel pressure, vehicle speed, air flow rate, and intake manifold pressure.

FREEZE FRAME	
P0300	Chevrolet Stored
	1/9
Fuel Sys 1	OL
Fuel Sys 2	NA
Calc Load	100.0(%)
ECT	79(°F)
STFT B1	0.0(%)
Press any Hotkey	

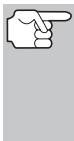

If more than one malfunction is present that causes more than one DTC to be set, only the code with the highest priority will contain Freeze Frame data. The code designated "01" on the Scan Tool display is referred to as the PRIORITY code, and Freeze Frame data always refers to this code. The priority code is also the one that has commanded the MIL on.

14. When the last retrieved DTC has been displayed and **DTC/FF** is pressed, the Scan Tool returns to the "Priority" Code.
15. Determine engine system(s) condition by viewing the display for any retrieved Diagnostic Trouble Codes, code definitions and Freeze Frame data, and interpreting the green, yellow and red LEDs.
 - If DTC's were retrieved and you are going to perform the repairs yourself, proceed by consulting the Vehicle's Service Repair Manual for testing instructions, testing procedures, and flow charts related to retrieved code(s).



THE SYSTEM MENU

The System Menu provides the ability to retrieve "enhanced" DTCs and Anti-Lock Brake System (ABS) DTCs for most Audi, BMW, Chrysler/Jeep, Ford/Mazda, GM/Isuzu, Hyundai, Kia, Mercedes Benz, Toyota/Lexus and Volkswagen vehicles. The types of enhanced data available depends on the vehicle make. You can also return to the Global OBD2 mode.

System Menu	
Select and press	
Global OBD2	
ABS	
Toyota OEM Enhanced	
Press any Hotkey	



Depending on the vehicle under test, some features and functions may not be available.



- To access the System Menu, press **SYSTEM MENU** . Select the desired option, then press **ENTER**  to view the selected information.

To view ABS DTCs: Select **ABS** from the System Menu. Refer to VIEWING ABS DTCs on page 13 to view ABS DTCs for your vehicle.

To view OEM enhanced DTCs: Select **OEM Enhanced** from the System Menu. Refer to VIEWING OEM ENHANCED DTCs on page 11 to view OEM enhanced DTCs for your vehicle.

VIEWING OEM ENHANCED DTCs (except Ford/Mazda)

When **(make) OEM Enhanced** is chosen from the System Menu, the Scan Tool retrieves OEM enhanced DTCs from the vehicle's computer.

1. A "One moment please" message displays while the Scan Tool retrieves the selected DTCs.
 - If the Scan Tool fails to link to the vehicle's computer, a "Communication Error" message shows.
 - Ensure your vehicle is OBD2 compliant.
 - Verify the connection at the DLC, and verify the ignition is ON.
 - Turn the ignition OFF, wait 5 seconds, then back ON to reset the computer.
 - Press **LINK**  to continue.
 - If the Scan Tool **cannot** link to the vehicle's computer after three attempts, the message "Contact Technical Support" displays.
 - Press **SYSTEM MENU**  to return to the System Menu.
 - Turn the ignition off, and disconnect the Scan Tool.
 - Contact Technical Support for assistance.
2. Refer to DISPLAY FUNCTIONS on page 3 for a description of LCD display elements.



If the definition for the currently displayed code is not available, an advisory message shows.







I/M MONITOR STATUS icons are not displayed when viewing enhanced DTCs.

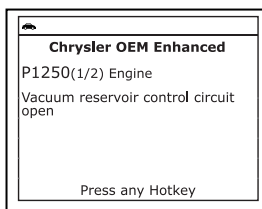

In the case of long code definitions, a small arrow is shown in the upper/lower right-hand corner of the code display area to indicate the presence of additional information.



- If no codes are present, the message "No OEM Enhanced DTC's are presently stored in the vehicle's computer" shows. Press **SYSTEM MENU**  to return to the System Menu.
3. If more than one code was retrieved press **DTC/FF** to display additional codes one at a time.
 - Whenever the Scroll function is used, the Scan Tool's communication link with the vehicle's computer disconnects. To re-establish communication, press **LINK**  again.
 4. When the last retrieved DTC has been displayed and **DTC/FF** is pressed, the Scan Tool returns to the "Priority" code.

- To exit the enhanced mode, press **SYSTEM MENU**  to return to the System Menu. Select **Global OBD**, then press **ENTER**  to return to the Global OBD2 mode.







VIEWING OEM ENHANCED DTCs (Ford/Mazda only)

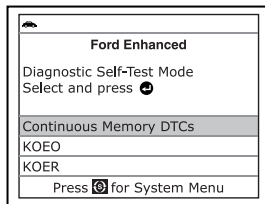



*Mazda Enhanced DTCs are available for **Mazda-branded Ford vehicles only.***

When **Ford OEM Enhanced** is chosen from the System Menu, the Ford OEM Enhanced menu displays. You may view DTCs for either the “Continuous Memory Test”, “KOEO (Key On Engine Off) Test” or “KOER (Key On Engine Running) Test.”



1. Select the desired option, then press **ENTER** .
- If **KOER** is selected, an advisory message shows.
 - Start and warm the engine to normal operating temperature, then press **ENTER** . Proceed to step 3.
2. If **KOEO** or **Continuous Memory** is selected, an “instructional” message shows.
 - Turn the ignition OFF, then back ON. Press **ENTER** . Proceed to step 3.
3. A “One moment please” message displays while the test is in progress.
 - If the Scan Tool fails to link to the vehicle’s computer, a “Communication Error” message shows.
 - Ensure your vehicle is OBD2 compliant.
 - Verify the connection at the DLC, and verify the ignition is ON.
 - Turn the ignition OFF, wait 5 seconds, then back ON to reset the computer.
 - Press **LINK**  to continue.
 - If the Scan Tool **cannot** link to the vehicle’s computer after three attempts, the message “Contact Technical Support” displays.
 - Press **SYSTEM MENU**  to return to the System Menu.
 - Turn the ignition off, and disconnect the Scan Tool.
 - Contact Technical Support for assistance.
 - If the **KOER** test was selected, and the vehicle’s engine *is not* running, an advisory message shows.
 - Start the engine and press **ENTER**  to try again, or, press **SYSTEM MENU**  to return to the System Menu.

- If the **KOEO** test was selected, and the vehicle's engine is *running*, an advisory message shows.
 - Turn the ignition OFF then back ON and press **ENTER**  to try again, or, press **SYSTEM MENU**  to return to the System Menu.
- 4. If the **KOER** test was selected, an "instructional" message shows.
 - Turn the steering wheel to the left, then release.
 - Press and release the brake pedal.
 - Cycle the overdrive switch (if equipped).
 - A "One moment please" message displays while the test is in progress.
- 5. Refer to **DISPLAY FUNCTIONS** on page 3 for a description of LCD display elements.





I/M MONITOR STATUS icons are not displayed when viewing enhanced DTCs.

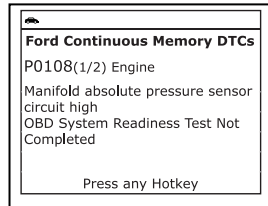

In the case of long code definitions, a small arrow is shown in the upper/ lower right-hand corner of the code display area to indicate the presence of additional information.



- If no codes are present, a "System Pass" displays. Press any Hotkey.
- 6. If more than one code was retrieved press **DTC/FF** to display additional codes one at a time.
- 7. When the last retrieved DTC has been displayed and **DTC/FF** is pressed, the Scan Tool returns to the "Priority" code.
 - To view *additional* enhanced DTCs, repeat steps 1 through 6, above.
 - To exit the enhanced mode, press **SYSTEM MENU**  to return to the System Menu. Select **Global OBD**, then press **ENTER**  to return to the Global OBD2 mode.

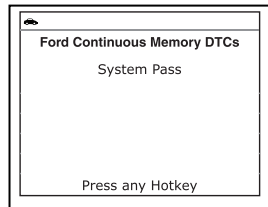



VIEWING ABS DTCs



Refer to the manufacturer's website for vehicle makes covered.

Reading ABS DTCs

1. When **ABS** is chosen from the System Menu, a "One moment please" message displays while the Scan Tool retrieves the selected DTCs.

- If ABS functionality is not supported, an advisory message shows. Press **SYSTEM MENU**  to return to the System Menu.
- If the Scan Tool fails to link to the vehicle's computer, a "Communication Error" message shows.
 - Ensure your vehicle is OBD2 compliant.
 - Verify the connection at the DLC, and verify the ignition is ON.
 - Turn the ignition OFF, wait 5 seconds, then turn back ON to reset the computer.
 - Press **LINK**  to continue.
- If the Scan Tool **cannot** link to the vehicle's computer after three attempts, the message "Contact Technical Support" displays.
 - Press **SYSTEM MENU**  to return to the System Menu.
 - Turn the ignition off, and disconnect the Scan Tool.
 - Contact Technical Support for assistance.

2. Refer to DISPLAY FUNCTIONS on page 3 for a description of LCD display elements.



If the definition for the currently displayed code is not available, an advisory message shows.







I/M MONITOR STATUS icons are not displayed when viewing ABS DTCs.

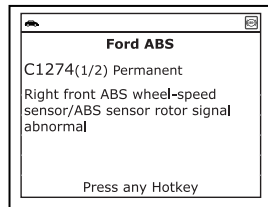

In the case of long code definitions, a small arrow is shown in the upper/lower right-hand corner of the code display area to indicate the presence of additional information.



- If no codes are present, the message "No ABS DTC's are presently stored in the vehicle's computer" shows. Press **SYSTEM MENU**  to return to the System Menu.
3. If more than one code was retrieved press **DTC/FF**, as necessary, to display additional codes one at a time.
- Whenever the Scroll function is used, the Scan Tool's communication link with the vehicle's computer disconnects. To re-establish communication, press **LINK**  again.
4. When the last retrieved DTC has been displayed and **DTC/FF** is pressed, the scan tool returns to the "Priority" code.
- To exit the enhanced mode, press **SYSTEM MENU**  to return to the System Menu. Select **Global OBD**, then press **ENTER**  to return to the Global OBD2 mode.

ERASING DIAGNOSTIC TROUBLE CODES (DTCs)



When the Scan Tool's ERASE function is used to erase DTCs from the vehicle's on-board computer, "Freeze Frame" data and manufacturer-specific enhanced data are also erased. "Permanent" DTCs ARE NOT erased by the ERASE function.

If you plan to take the vehicle to a Service Center for repair, **DO NOT** erase the codes from the vehicle's computer. If the codes are erased, valuable information that might help the technician troubleshoot the problem will also be erased.

Erase DTCs from the computer's memory as follows:



When DTCs are erased, the I/M Readiness Monitor Status program resets status of all Monitors to a not run condition. To set all Monitors to a DONE status, an OBD2 Drive Cycle must be performed.

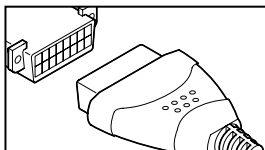

1. If not connected already, connect the Scan Tool to the vehicle's DLC, and turn the ignition "On." (If the Scan Tool is already connected and linked to the vehicle's computer, proceed directly to step 3. If not, continue to step 2.)



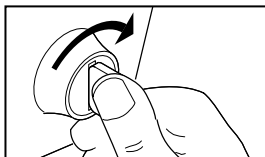

2. Perform the Code Retrieval procedure as described on page 6.

- **To erase OBD2 DTCs:** Wait until the codes are displayed, then proceed to step 3.



- **To erase OEM enhanced or ABS DTCs:** Press **SYSTEM MENU**  to display the System Menu. Select the desired option, then press **ENTER** . Perform the appropriate Code Retrieval procedure and then proceed to step 3.

3. Press and release **ERASE** . A confirmation message shows.

- If you are sure you want to proceed, select **YES**, then press **ENTER** .
- If you do not want to proceed, select **NO**, then press **ENTER**  to cancel the erase procedure.

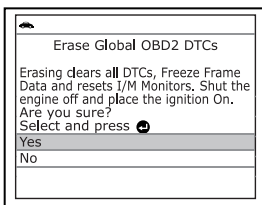

- If you chose to erase DTCs, a "One moment please..." message displays while the erase function is in progress.



*If the vehicle's engine is running, an advisory message shows. Turn the engine OFF, then turn the ignition back to ON. DO NOT start the engine. Press **ENTER**  to continue.*

- If the erase was successful, a confirmation message shows. The Scan Tool automatically relinks to the vehicle's computer after 3 seconds.



*If the erase was not successful and ECU error code \$22 is present, an advisory message displays. Start the engine and maintain vehicle speed at 0. Choose **Erase DTCs** to try again.*

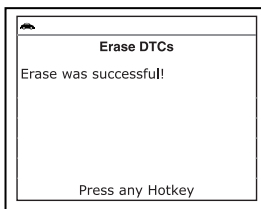

- If the erase was not successful, an advisory message shows indicating the erase request was sent to the vehicle's computer. The Scan Tool automatically relinks to the vehicle's computer after 3 seconds.

ABOUT REPAIRSOLUTIONS 2®

RepairSolutions 2® is a web-based service created to assist both Do-It-Yourself and Professional technicians in quickly and accurately diagnosing and repairing today's vehicles. RepairSolutions 2 allows you to view and save the diagnostic data retrieved from a vehicle's on-board computer(s) using your Code Reader. At the core of RepairSolutions 2 is an extensive knowledge database, developed by compiling and analyzing years worth of "real world" vehicle service data. RepairSolutions 2 builds on manufacturer-recommended diagnostic and repair information by providing verified, vehicle-specific fixes supplied by ASE technicians across the country. RepairSolutions 2 also provides access to an extensive knowledge database including:

- **Verified Fixes** – Find the most likely fixes reported and verified by ASE Technicians for the retrieved DTCs.
- **Repair Instructions** – View available repair instructions to properly perform the fix.
- **Video Tutorials** – Watch repair video tutorials for valuable repair tips.
- **Technical Service Bulletins** – Research known problems reported by vehicle manufacturers.
- **Safety Recalls** – Research known safety concerns applicable to a vehicle.

And much more. Please visit www.innova.com for additional information.

Hardware Requirements:

- Innova Scan Tool with Bluetooth/WiFi
- Android or iOS Smart Device

Accessing RepairSolutions 2®

1. Download and install the RepairSolutions 2® app from the App Store (for iOS devices) or Google Play (for Android devices).
2. Launch the RepairSolutions 2 app and log in to your account.

- If you have not yet established an account, you must register for a FREE RepairSolutions 2 account before proceeding.
- 3. Connect the Code Reader to a vehicle and establish a Bluetooth or WiFi connection with your Smart Device (refer to CONNECTING TO BLUETOOTH / WIFI, below). Be sure your Smart Device is connected to an available WiFi network.
 - The RepairSolutions 2 app will store two WiFi configurations only.
- 4. Retrieve diagnostic data (refer to CODE RETRIEVAL PROCEDURE on page 6 for details).
- 5. The RepairSolutions 2 app automatically displays a report based on the retrieved diagnostic data.
 - If the Code Reader is not connected to WiFi or Bluetooth, vehicle data will not be saved.

CONNECTING TO BLUETOOTH / WIFI

Launch the RepairSolutions 2 app and follow the prompts to establish Bluetooth and (optionally) WiFi connections, as follows:

1. Launch the RepairSolutions 2 app. Select **Wifi Tools Settings** from the menu. Power on your Code Reader, then select from the list of available devices.
2. When Bluetooth pairing is complete, a confirmation screen displays. Click **Continue**.
 - If a Bluetooth connection cannot be established, an advisory message displays. Tap **Try Again** to repeat the pairing process.
3. Follow the on-screen prompts to connect to an available WiFi network.
 - You can automatically connect to the network your Smart Device is currently connected to, or you can manually connect to another available network.
 - Note that only 2.4GHz networks are supported.
 - If you do not wish to connect to a WiFi network at this time, tap **SKIP**.
4. When WiFi pairing is complete, a confirmation screen displays. Click **Continue** to view the "Setup Complete" message, then click **Continue** to enter RepairSolutions 2.
 - If a WiFi connection cannot be established, an advisory message displays. Tap **Try Again** to repeat the pairing process.

The Scan Tool lets you view and/or record "real-time" Live Data. This information includes values (volts, rpm, temperature, speed etc.) and system status information (open loop, closed loop, fuel system status, etc.) generated by the various vehicle sensors, switches and actuators.

These are the same signal values generated by the sensors, actuators, switches and/or vehicle system status information used by the vehicle's computer when calculating and conducting system adjustments and corrections.

The real time (Live Data) vehicle operating information (values/status) that the computer supplies to the Scan Tool for each sensor, actuator, switch, etc. is called Parameter Identification (PID) Data.

Each PID (sensor, actuator switch, status, etc.) has a set of operating characteristics and features (parameters) that serve to identify it. The Scan Tool displays this information for each sensor, actuator, switch or status that is supported by the vehicle under test.



WARNING: If the vehicle must be driven in order to perform a troubleshooting procedure, **ALWAYS** have a second person help you. One person should drive the vehicle while the other person observes the Scan Tool data. Trying to drive and operate the Scan Tool at the same time is dangerous, and could cause a serious traffic accident.

VIEWING LIVE DATA

1. While linked to the vehicle, start the engine, then press **LD**.
2. A "One moment please . . ." message displays while the Scan Tool establishes communication with the vehicle.
 - If the Scan Tool fails to establish communication with the vehicle, a "Communication Error" message displays.
 - Ensure the vehicle is OBD2 compliant.
 - Verify the connection at the DLC, and verify the ignition is ON.
 - Turn the ignition OFF, wait 5 seconds, then back ON to reset the computer.
 - Press **ENTER**  to continue.
3. Real-time Live Data (PID) information supported by the vehicle under test displays.
 - If Live Data is not supported by the vehicle under test, an advisory message displays. Press **M** to return to the Main Menu. Live Data is not available for your vehicle.

Powertrain Live Data	
PCM PID	1/44
Fuel Sys 1	OL
Fuel Sys 2	OL
Calc Load	0.0 (%)
ECT	-40 (°F)
STFT B1	0.0 (%)
LTFT B1	0.0 (%)

Press any Hotkey



The values for the various PIDS displayed may change as the vehicle's operating conditions change.

- Only a limited amount of PID data can be displayed on the screen at one time. If additional PID data is available, a small arrow is shown on the display. Press **UP ▲** and **DOWN ▼**, as necessary, to view all available PID data.
 - If communication with the vehicle is lost while viewing Live Data, an advisory message displays.
- Press and release **ENTER ↵** to view the currently selected PID in "graph" mode. Press and release **ENTER ↵** again to return to the PID list.
 - You can display a maximum of two PIDs in "graph" mode at any given time.
 - With two PID shown in "graph" mode, press and hold **LD** to superimpose one graph on the other. Release **LD** to separate the graphs.
- Press and hold **ENTER ↵** to view the "expanded" definition for the currently selected PID. Release to return to the PID list.
- If you experience vehicle problems, view and/or compare the Live Data (PID) information displayed on the Scan Tool to specifications in the vehicle's repair manual.

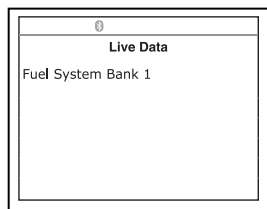
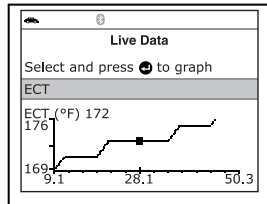

CUSTOMIZING LIVE DATA (PIDs)





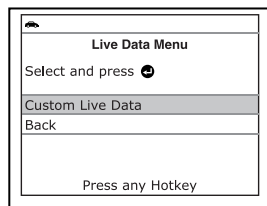



You can customize the Live Data display by placing the Scan Tool in "Custom Live Data" mode and selecting only the PIDs that you wish to display.

- With the Scan Tool in Live Data mode (see VIEWING LIVE DATA on page 18), press and hold **LD** to access the Live Data Menu, then release.
- Select **Custom Live Data**, then press **ENTER ↵**.
 - If the Scan Tool fails to establish communication with the vehicle, a "Communication Error" message displays.
 - Ensure your vehicle is OBD2 compliant.
 - Verify the connection at the DLC, and verify the ignition is ON.
 - Turn the ignition OFF, wait 5 seconds, then back ON to reset the computer.
 - Press **LINK**  to continue.



Live Data Mode

CUSTOMIZING LIVE DATA (PIDs)

- If Live Data is not supported by the vehicle under test, an advisory message displays. Press **SYSTEM MENU**  to return to the System Menu.
 - If custom Live Data was previously configured, the Select PIDs to Use screen displays.
 - To use the *existing* custom Live Data selections, select **Use existing PIDs**, then press **ENTER** . Proceed to step 5.
 - To configure *new* custom Live Data, select **Select new PIDs**, then press **ENTER** . The Custom Live Data menu displays. Proceed to step 3.
 - If custom Live Data was not previously selected, the Custom Live Data menu displays. Proceed to step 3.
3. Press **UP**  and **DOWN**  to scroll through the available PIDs. When the PID you wish to display is highlighted, press **ENTER**  (a "checkmark" shows to confirm your selection). Repeat until only the PIDs you want to display are selected.
- To deselect a PID, highlight the PID, then press **ENTER** . The checkmark is removed.
4. When you are finished making your selection(s), press **LD** to continue.
- If *no PIDs* have been selected, an advisory message displays. Press **ENTER**  to return to the Custom Live Data menu.
5. The Scan Tool is now in "Custom Live Data" mode. Only the PIDs you selected are shown.
- To change the current custom Live Data selections, select **Reselect PIDs**, then press **ENTER**  to return to the Custom Live Data menu. Repeat step 3.
6. To exit the "Custom Live Data" mode, press **LD** to return to the Live Data Menu.

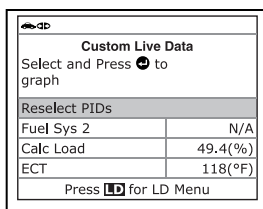
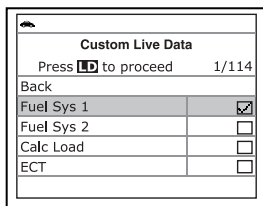

In addition to retrieving Diagnostic Trouble Codes (DTCs), you can use the scan tool to perform additional diagnostic tests, to view diagnostic and vehicle information stored in your vehicle's on-board computer, and to configure the scan tool for your particular needs. Additional tests and related functions are accessed through the Main Menu. The following functions are available:

- **System Tests** – Displays the System Test menu, which lets you retrieve and view results for the O2 Sensor Test and OBD Monitor Test, and lets you initiate a test of the vehicle's EVAP system.
- **Vehicle Information** – Displays the Vehicle Info menu, which lets you retrieve and view reference information for the vehicle under test.
- **Battery/Alternator Monitor** – Performs a check of the vehicle's battery and alternator system to ensure the system is operating within acceptable limits.
- **Firmware Version** – Displays the diagnostic tool's firmware version.
- **Tool Library** – Displays the Tool Library menu, which provides access to OBD1 and OBD2 DTC libraries and to definitions for Monitor icons and LED indications.
- **Tool Settings** – Displays the Tool Settings menu, which lets you make several adjustments and settings to configure the diagnostic tool to your particular needs.

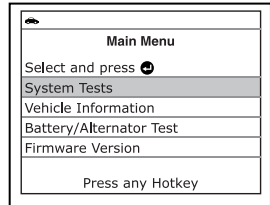

The **Vehicle Information** option is shown only when the scan tool is in Global OBD2 mode.

SYSTEM TEST MENU

Additional tests are accessed through the System Tests menu. The following functions are available:

- **O2 Sensor Test** - Retrieves and displays O2 sensor monitor test results from your vehicle's on-board computer.
 - **OBD Monitor Test** - Retrieves and displays test results for emission-related powertrain components and systems that are not continuously monitored.
 - **EVAP Test** - Performs a leak test for the vehicle's EVAP system.
1. While linked to the vehicle, press **M**.
 - The Main Menu displays.
 2. Select **System Tests**, then press **ENTER** .
 - The System Test menu displays.



If **System Tests** is not shown on the Main Menu, the System Tests functions are not available for your vehicle.

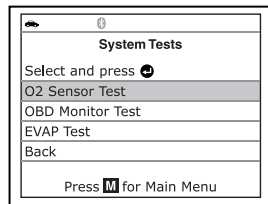

O2 Sensor Test

OBD2 regulations require that applicable vehicles monitor and test operation of the oxygen (O2) sensors to identify problems that can affect fuel efficiency and vehicle emissions. These tests are performed automatically when engine operating conditions are within predefined limits. Results of these tests are stored in the on-board computer's memory.

The **O2 Sensor Test** function lets you retrieve and view O2 sensor monitor test results for the most recently completed tests from your vehicle's on-board computer.



The scan tool does not perform O2 sensor tests, but retrieves results from the most recently performed O2 sensor tests from the on-board computer's memory. You may retrieve O2 sensor test results for only one test of one sensor at any given time.

1. From the System Test menu, select **O2 Sensor Test**, then press **ENTER** .

2. A "One moment please..." message displays, followed by the select sensor screen.

- The Select Sensor screen displays. The screen shows all O2 sensors applicable to the vehicle under test.

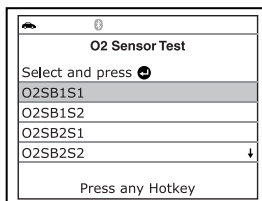

*If O2 sensor test data is not presently stored in the vehicle's computer, an advisory message displays. Press **M** to return to the Main Menu.*





*If O2 sensor tests are not supported by the vehicle under test, an advisory message displays. Press **M** to return to the Main Menu.*

3. Select the O2 sensor for which you wish to view test results, then press **ENTER**  to display the test results.

4. When test results have been retrieved, data for the selected sensor test will show on the diagnostic tool's display.

5. When you have finished viewing the retrieved test data:

- To view test results for the next sensor, select **Next**, then press **ENTER** .
- To return to the Select Sensor screen, select **Back**, then press **ENTER** .

6. When you have finished viewing test data for all desired sensors, select **Back**, then press **ENTER**  to return to the System Test menu; or, press **M** to return to the Main Menu.

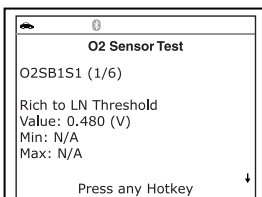

OBD Monitor Test

The **OBD Monitor Test** function retrieves and displays test results for emission-related powertrain components and systems that are not continuously monitored. The tests available are determined by the vehicle manufacturer.



The diagnostic tool does not perform the OBD monitor test, but retrieves results from the most recently performed tests from the on-board computer's memory. You may retrieve OBD monitor test results for only one test at any given time.

1. From the System Test menu, select **OBD Monitor Test**, then press **ENTER** .
2. A "One moment please. . ." message displays, followed by the Select Test screen. (Refer to the vehicle's service repair manual for information related to non-continuous tests.)

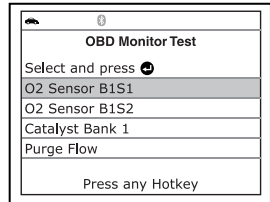

*If OBD monitor test data is not presently stored in the vehicle's computer, an advisory message displays. Press **M** to return to the Main Menu.*



*If OBD monitor tests are not supported by the vehicle under test, an advisory message displays. Press **M** to return to the Main Menu.*

3. Select the desired test, then press **ENTER**  to display the test results. The display shows the following information:

- **Test ID** number
- **Module ID** number
- **Component ID** number
- **Min** or **Max** test limit (*Only one test limit, either **Min** or **Max**, is shown for any given test.*)
- **Test Value** and status

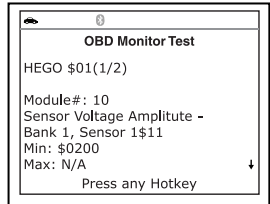

*Status is calculated by the diagnostic tool by comparing the **Test Value** against the displayed test limit (either **Min** or **Max**). Status is shown as either **Low**, **High** or **OK**.*

4. When you have finished viewing the retrieved test data, select **Back** on the Select Test screen, then press **ENTER**  to return to the System Test menu; or, press **M** to return to the Main Menu.

EVAP Test



The **EVAP Test** function lets you initiate a leak test for the vehicle's EVAP system.

Additional Functions

VIEWING VEHICLE INFORMATION



The scan tool does not perform the leak test, but signals to vehicle's on-board computer to initiate the test. The vehicle manufacturer determines the criteria and method for stopping the test once it has been started. Refer to the vehicle's service repair manual to determine the procedures necessary to stop the test.

1. From the System Test menu, select **EVAP Test**, then press **ENTER** .
2. A "One moment please..." message displays.
3. When the EVAP leak test has been initiated by the vehicle's on-board computer, a confirmation message displays. Select **Back**, then press **ENTER**  to return to the System Test menu; or, press **M** to return to the Main Menu.

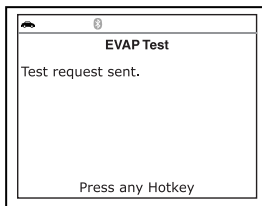

Some vehicle manufacturers do not allow diagnostic tools or other external devices to control vehicle systems. If the **EVAP Test** is not supported by the vehicle under test, an advisory message shows on the diagnostic tool's display. Press the **M** button to return to the Main Menu.

VIEWING VEHICLE INFORMATION

The Scan Tool offers three options for retrieving reference information for the vehicle under test; **Vehicle ID**, **Available Modules** and **IPT** (In-use Performance Tracking).

Retrieving Vehicle ID Information





The **Vehicle ID** function is applicable to model year 2000 and newer OBD2-compliant vehicles.

The Scan Tool can retrieve a list of information (provided by the vehicle manufacturer), unique to the vehicle under test, from the vehicle's on-board computer. This information may include:

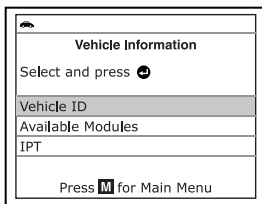
- The vehicle's VIN number
- The control module identification number
- The vehicle's calibration ID(s). These IDs uniquely identify the software version(s) for the vehicle's control module(s).
- The Vehicle's Calibration Verification Number(s) (CVNs) required by OBD2 regulations. CVNs are used to determine if emission-related calibrations for the vehicle under test have been changed. One or more CVNs may be returned by the vehicle's computer.



1. While linked to a vehicle, press **M**.
 - The “Main Menu” displays.
2. Select **Vehicle Information**, then press **ENTER** .
3. Select **Vehicle ID**, then press **ENTER** .



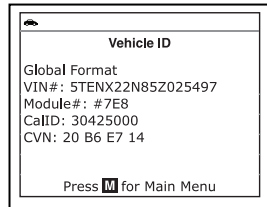

*The first time the **Vehicle ID** function is used, it may take several minutes to retrieve the information from the vehicle's computer.*

4. When the retrieval process is completed, the vehicle ID information displays.
5. When you have finished viewing the retrieved vehicle ID information, press **M** to exit.



Viewing Available Modules

The Scan Tool can retrieve a list of modules supported by the vehicle under test.

1. While linked to a vehicle, press **M**.
 - The “Main Menu” displays.
2. Select **Vehicle Information**, then press **ENTER** .
3. Select **Available Modules**, then press **ENTER** .

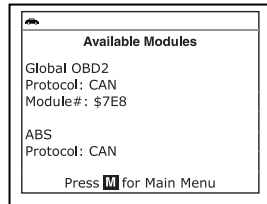

4. When the retrieval process is completed, a complete list of modules supported by the vehicle under test displays.
5. When you have finished viewing the list of available modules, press **M** to exit.

Viewing In-use Performance Tracking (IPT)

The Scan Tool can retrieve In-use Performance Tracking (IPT) statistics for monitors supported by the vehicle under test. Two values are returned for each monitor; the number of times that all conditions necessary for a specific monitor to detect a malfunction have been encountered (XXXCOND), and the number of times that the vehicle has been operated under the specific conditions for the monitor (XXXCOMP). Statistics are also provided for the number of times the vehicle has been operated in OBD monitoring conditions (OBDCOND), and the number of times the vehicle's engine has been started (IGNCNTR).

1. While linked to a vehicle, press **M**.
 - The “Main Menu” displays.

Additional Functions

BATTERY/ALTERNATOR TEST

2. Select **Vehicle Information**, then press the **ENTER**  button.

- The Vehicle Information menu displays.

3. Select **IPT**, then press **ENTER** .

4. When the retrieval process is completed, the In-use Performance Tracking statistics for the vehicle under test display.

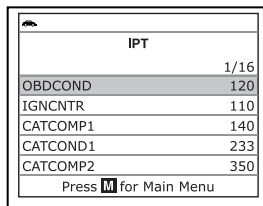

IPT	
1/16	
OBDCOND	120
IGNCNTR	110
CATCOMP1	140
CATCOND1	233
CATCOMP2	350

Press **M** for Main Menu

- If In-use Performance Tracking is not available for your vehicle, an advisory message shows on the diagnostic tool's display. Press **M** to return to the Main Menu.

5. When you have finished viewing the statistics, press **M** to exit.

BATTERY/ALTERNATOR TEST

The Scan Tool can perform a check of the vehicle's battery and alternator system to ensure the system is operating within acceptable limits. You can perform a battery check *only*, or an alternator system (battery and alternator) check.

To perform a battery check ONLY:

1. Press **M** and release.

- The Main Menu displays.

2. Select **Battery/Alternator Test**, then press **ENTER** .

- The Battery/Alternator Monitor Menu displays.

3. Select **Battery Test**, then press **ENTER** .

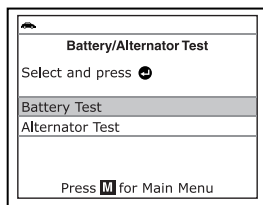

Battery/Alternator Test	
Select and press M	
Battery Test	
Alternator Test	

Press **M** for Main Menu

- An "instructional" message displays, showing the procedures to prepare the vehicle for the battery check.

4. Prepare the vehicle for the battery check:

- Turn the engine off.
- Place the transmission in **PARK** or **NEUTRAL**, and set the parking brake.
- Make a visual check of the battery's condition. If the battery terminals are corroded or other damage is present, clean or replace the battery as appropriate.
- For "unsealed" batteries, make sure the water level in each cell is above the battery plates.
- Turn the ignition on. **DO NOT** start the engine.

5. Press **ENTER** to begin the battery check.



If the engine is running, an advisory message shows. Turn the engine off, then turn the ignition on. **DO NOT** start the engine. Press **ENTER** to continue.

- An “instructional” message shows.
6. Turn the vehicle’s headlights on, then press **ENTER** to continue.
 - A “countdown” message shows while the battery check is in process.
 - If battery voltage is *less than* 12.1 volts, an advisory message shows. Press **M** to return to the Main Menu. Turn the ignition off and disconnect the scan tool from the vehicle. Fully charge the battery, then repeat the battery check.
 - If battery voltage is *greater than* 12.1 volts, an “instructional” message shows.
 7. Turn the vehicle’s headlights off, then press **ENTER** to continue.
 - An “instructional” message shows.
 8. Start the vehicle’s engine. Allow the engine to run for several seconds, then turn the engine off. Repeat for a total of three “start/stop” cycles.



If the scan tool did not detect “cranking status” for the vehicle’s engine, an advisory message shows. Press **ENTER** to repeat the battery check, or, press **M** to return to the Main Menu.

9. When the battery check is complete, a results screen displays the battery status. The System Status LEDs provide a PASS/FAIL indication, as follows:
 - Green = Good
 - Yellow = Normal
 - Red = Warning/Bad

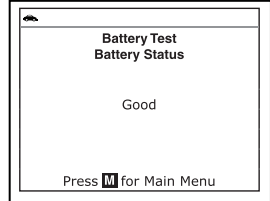

10. Press **M** to return to the Main Menu.

To perform an alternator system check:

1. Press **M** and release.
 - The Main Menu displays.
 2. Select **Battery/Alternator Monitor**, then press **ENTER** .
 3. Select **Alternator Monitor**, then press **ENTER** .
- An “instructional” message shows.

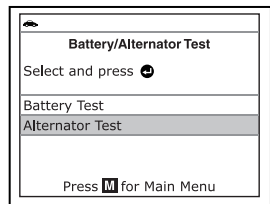

Additional Functions

VIEWING THE FIRMWARE VERSION - THE TOOL LIBRARY

- Start and warm the engine to normal operating temperature. Turn on the headlights. Press **ENTER**  to continue.
 - An “instructional” message shows.
- Press the accelerator pedal to raise engine speed to 2000 RPM, and maintain the engine speed.
 - When engine speed is within the required range, the alternator test begins. A progress screen shows.
 - When the “countdown” timer expires, an “instructional” message shows.
- Turn the vehicle’s headlights off, and return the engine to idle speed.
 - A “One moment please...” message displays while the test results are retrieved.
- When the alternator check is complete, a results screen shows charging system voltage and indicates whether or not the charging system is within acceptable limits. The **SYSTEM STATUS** LEDs provide a PASS/FAIL indication, as follows:
 - Green = System within limits
 - Yellow = Over charging or under charging
 - Red = Excessive over charging or under charging
 - If the alternator voltage is less than 9 V, the red, yellow and green **SYSTEM STATUS** LEDs will flash on and off.
- Press **M** to return to the Main Menu.

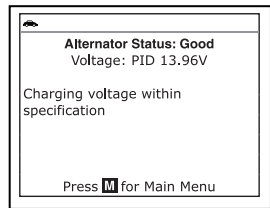
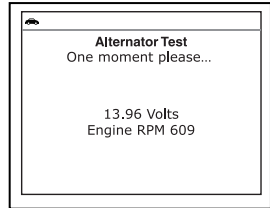

VIEWING THE FIRMWARE VERSION

- Select **Firmware Version** in the Main Menu, then press **ENTER** .
- Press **M** to return to the Main Menu.

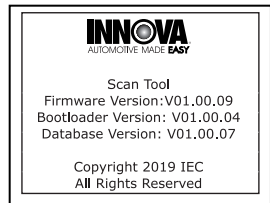

THE TOOL LIBRARY

The Tool Library contains valuable reference information for the Scan Tool. The following functions are available:

- **Tool Icons** – Shows the full names for the **I/M MONITOR STATUS** icons and descriptions of informational icons shown on the scan tool's display.
 - **DTC Library** – Provides access to a library of OBD2 DTC definitions.
 - **LED Definitions** – Provides descriptions of the meaning of the scan tool **SYSTEM STATUS** LEDs.
1. While linked to the vehicle, press **M**.
 - The Main Menu displays.
 2. Select **Tool Library**, then press **ENTER** \leftarrow .

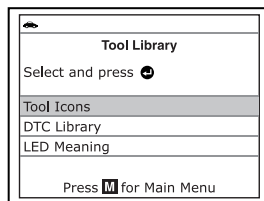

Viewing Tool Icon Descriptions

The **I/M MONITOR STATUS** icons on the scan tool's LCD display provide an indication of the "Completed / Not Complete" status for all I/M Monitors supported by the vehicle under test. The **Tool Icons** function displays the full name for each Monitor icon, as well as descriptions of the meanings of other informational icons shown on the scan tool's display.

1. From the Tool Library menu, select **Tool Icons**, then press **ENTER** \leftarrow .
 - The Tool Icons screen displays.
 - The screen shows a list of the 15 Monitor icons, along with the full name for each icon, as well as descriptions of the meanings of other informational icons. Use the **UP** \blacktriangle and **DOWN** \blacktriangledown buttons, as necessary, to scroll the list.

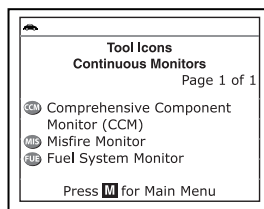

2. When you have finished viewing the tool icon descriptions, press **M** to return to the Main Menu.

Using the DTC Library

1. From the Tool Library menu, select **DTC Library**, then press **ENTER** \leftarrow .
 - The Select Library screen displays.
2. Select **OBD2 Library**, then press **ENTER** \leftarrow .
 - The Select Manufacturer screen displays.
3. Select the desired vehicle manufacturer, then press **ENTER** \leftarrow .
 - The Enter DTC screen displays. The screen shows the code "P0001," with the "P" highlighted.

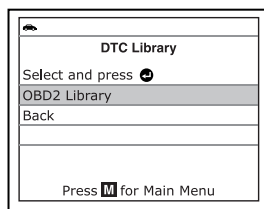

Additional Functions

ADJUSTMENTS AND SETTINGS

- Use the **UP** ▲ and **DOWN** ▼ buttons, as necessary, to scroll to the desired DTC type (P=Powertrain, U=Network, B=Body, C=Chassis), then press the **DTC** button.

- The selected character displays solid, and the next character is highlighted.

- Select the remaining digits in the DTC in the same way. When you have selected all the DTC digits, press **ENTER** ↵ to continue.

- When you have finished viewing the DTC definition, highlight **Back**, then press **ENTER** ↵ to return to the Enter DTC screen and enter additional DTCs; or, press **M** to return to the Main Menu.

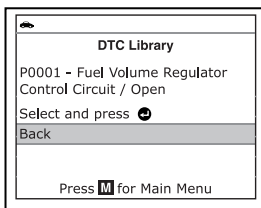
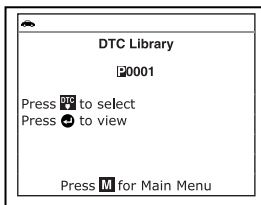

If a definition for the DTC you entered is not available, an advisory message shows Highlight **Back**, then press **ENTER** ↵ to return to the Enter DTC screen and enter additional DTCs; or, press **M** to return to the Main Menu.

Viewing LED Definitions

The **SYSTEM STATUS** LEDs on the scan tool provide a visual indication of the I/M Readiness status of the vehicle under test. The **LED Definitions** function provides a description of the meanings of the green, yellow and red **SYSTEM STATUS** LEDs.

- From the Tool Library menu, select **LED Definitions**, then press **ENTER** ↵.

- The LED Meaning screen displays.
- The screen provides a description of the meanings of the green, yellow and red **SYSTEM STATUS** LEDs.

- When you have finished viewing the LED meanings, press **M** to return to the Main Menu.

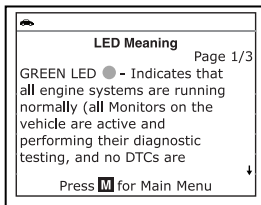

ADJUSTMENTS AND SETTINGS

You can access the Adjustments and Settings MENU while the Scan Tool is in "Live Data" mode. The Scan Tool lets you make several adjustments and settings to configure the Scan Tool for your particular needs. The following adjustments and settings are available:

- Adjust Brightness:** Adjusts the brightness of the display screen.
- Audible Tone:** Turns the Scan Tool's audible tone "on" and "off." When turned "on," a tone sounds each time a button is pressed.



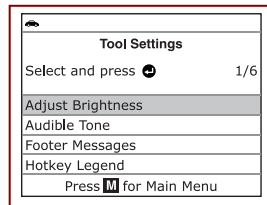

- **Footer Messages:** Turns the navigational “footers” at the bottom of most display screens “on” and “off.”
- **Hotkey Legend:** Shows functional descriptions for the diagnostic tool’s hotkeys.
- **Language Selection:** Sets the display language for the Scan Tool to English, French or Spanish.
- **Unit of Measurement:** Sets the Unit of Measurement for the Scan Tool’s display to USA or Metric.

To enter the Tool Settings Menu:

1. While linked to the vehicle, press and release the **M** button.
 - The Main Menu displays.
2. Select **Tool Settings**, then press **ENTER** .
- The Tool Settings menu displays.
3. Make adjustments and settings as follows.



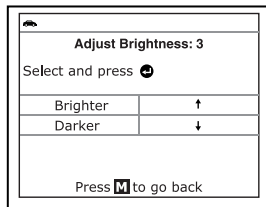

Adjusting Display Brightness

1. Select **Adjust Brightness** in the Tool Settings menu, then press **ENTER** .
- The Adjust Brightness screen displays.
2. Press **UP**  and **DOWN**  to make the display lighter or darker, then press **ENTER**  to save your changes.



To return to the Tool Settings menu without making changes, press **M**.

Enabling/Disabling the Audible Tone

1. Select **Audible Tone** in the Tool Settings menu, then press **ENTER** .
- The Audible Tone screen displays.
2. Select **On** or **Off** as desired, then press **ENTER**  to save your changes.



To return to the Tool Settings menu without making changes, press **M**.

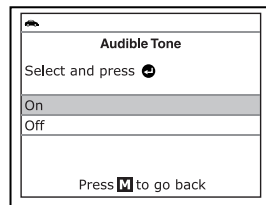

Enabling/Disabling Navigational Footers

1. Select **Footer Messages** in the Tool Settings menu, then press **ENTER** \leftarrow .
 - The Footer Messages screen displays.
2. Select **On** or **Off** as desired, then press **ENTER** \leftarrow to save your changes.

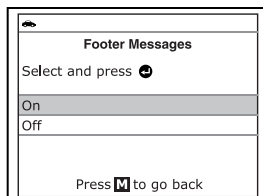

To return to the Tool Settings menu without making changes, press **M**.

Viewing the Hotkey Legend

1. Select **Hotkey Legend** in the Tool Settings menu, then press **ENTER** \leftarrow .
 - The Hotkey Legends screen displays.
 - The screen shows a functional description of each of the scan tool's hotkeys.
2. When you have finished viewing the Hotkey Legend, press **ENTER** \leftarrow to return to the Tool Settings menu.

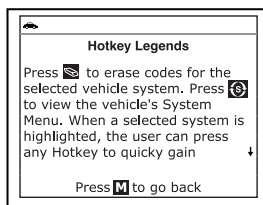

Selecting the Display Language

1. Select **Language Selection** in the Tool Settings menu, then press **ENTER** \leftarrow .
 - The Language Selection screen displays.
2. Select the desired display language, then press **ENTER** \leftarrow to save your changes.

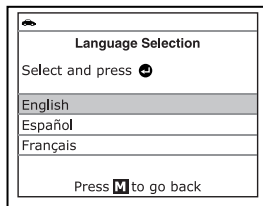

To return to the Tool Settings menu without making changes, press **M**.

Setting the Unit of Measurement

1. Select **Unit of Measurement** in the Tool Settings menu, then press **ENTER** \leftarrow .
 - The Unit of Measurement screen displays.
2. Select the desired unit of measurement, then choose **Save** to save your changes.

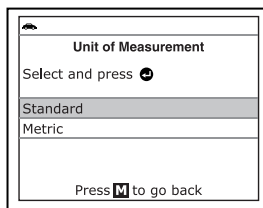

To return to the Tool Settings menu without making changes, press **M**.

Exiting the Tool Settings Menu

- Press **M** to return to the Main Menu.

LIMITED ONE YEAR WARRANTY

The Manufacturer warrants to the original purchaser that this unit is free of defects in materials and workmanship under normal use and maintenance for a period of one (1) year from the date of original purchase.

If the unit fails within the one (1) year period, it will be repaired or replaced, at the Manufacturer's option, at no charge, when returned prepaid to the Service Center with Proof of Purchase. The sales receipt may be used for this purpose. Installation labor is not covered under this warranty. All replacement parts, whether new or remanufactured, assume as their warranty period only the remaining time of this warranty.

This warranty does not apply to damage caused by improper use, accident, abuse, improper voltage, service, fire, flood, lightning, or other acts of God, or if the product was altered or repaired by anyone other than the Manufacturer's Service Center.

The Manufacturer, under no circumstances shall be liable for any consequential damages for breach of any written warranty of this unit. This warranty gives you specific legal rights, and you may also have rights, which vary from state to state. This manual is copyrighted with all rights reserved. No portion of this document may be copied or reproduced by any means without the express written permission of the Manufacturer. **THIS WARRANTY IS NOT TRANSFERABLE.** For service, send via U.P.S. (if possible) prepaid to Manufacturer. Allow 3-4 weeks for service/repair.

SERVICE PROCEDURES

If you have any questions, require technical support or information on UPDATES and OPTIONAL ACCESSORIES, please contact your local store, distributor or the Service Center.

USA & Canada:

(800) 544-4124 (6:00 AM-6:00 PM, Monday through Saturday)

All others: (714) 241-6802 (6:00 AM-6:00 PM, Monday through Saturday)

FAX: (714) 241-3979 (24 hr.)

Web: www.innova.com



TECHNICAL ASSISTANCE
1 800 544 4124
HABLAMOS ESPAÑOL • SERVICE IN THE USA
ASE CERTIFIED TECHNICIANS

INNOVA.COM

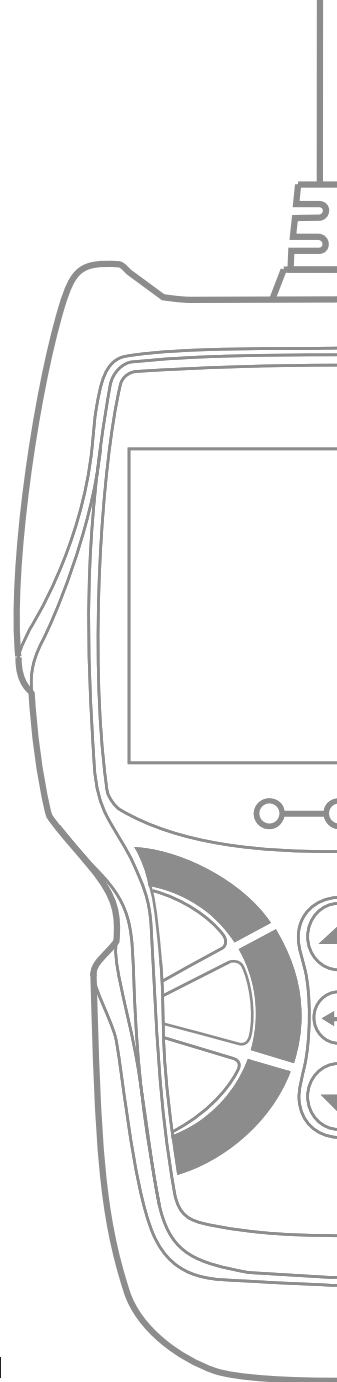

INNOVA

Innova Electronics Corp.
17352 Von Karman Ave.
Irvine, CA 92614

