

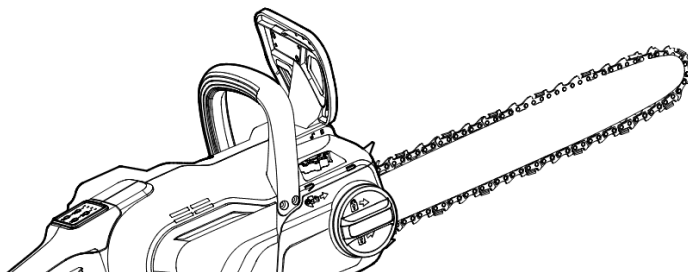

# 40-Volt Cordless Chain Saw

A40LJ14B01 /A40LJ16B01

OPERATOR'S MANUAL



# TABLE OF CONTENTS

Safety Symbols.....	4
Safety Instructions.....	5-16
Introduction.....	17
Specifications.....	17
Packing List.....	18
Description.....	19-21
Assembly.....	22
Operation.....	23-35
Maintenance.....	35-45
Troubleshooting.....	46-47
Warranty.....	48-50
Parts List.....	51-52

# READ ALL INSTRUCTIONS!



READ & UNDERSTAND  
INSTRUCTION MANUAL

**⚠ WARNING:** Some dust created by power cutting contains chemicals known to the state of California to cause cancer, birth defects or other reproductive harm. Some examples of these chemicals are:

- Lead from lead-based paints
- Crystalline silica from bricks and cement and other masonry products, and
- Arsenic and chromium from chemically-treated lumber.

Your risk from these exposures varies, depending on how often you do this type of work. To reduce your exposure to these chemicals: work in a well ventilated area, and work with approved safety equipment, such as those dust masks that are specially designed to filter out microscopic particles.

# SAFETY SYMBOLS

The purpose of safety symbols is to attract your attention to possible dangers. The safety symbols and the explanations with them deserve your careful attention and understanding. The symbol warnings do not, by themselves, eliminate any danger. The instructions and warnings they give are no substitutes for proper accident prevention measures.

**⚠ WARNING:** Be sure to read and understand all safety instructions in this Operator's Manual, including all safety alert symbols such as "DANGER," "WARNING," and "CAUTION" before using this tool. Failure to following all instructions listed below may result in electric shock, fire, and and/or serious personal injury.

## SYMBOL MEANING

**⚠ SAFETY ALERT SYMBOL:** Indicates DANGER, WARNING, OR CAUTION.

May be used in conjunction with other symbols or pictographs.















**⚠ WARNING!** The operation of any power tools can result in foreign objects being thrown into your eyes, which can result in severe eye damage. Before beginning power tool operation, always wear safety goggles or safety glasses with side shield and a full face shield when needed. We recommend a Wide Vision Safety Mask for use over eyeglasses or standard safety glasses with side shields. Always use eye protection which is marked to



comply with ANSI Z87.1.

# SAFETY INSTRUCTIONS

This page depicts and describes safety symbols that may appear on this product. Read, understand, and follow all instructions on the machine before attempting to assemble and operate.

	Safety Alert	Indicates a potential personal injury hazard.
	Read Operator's Manual	To reduce the risk of injury, user must read instruction.
	Wear Eye Protection	Always wear safety goggles or safety glasses with side shields and a full face shield when operating this product.
	Wear Ear Protection	Chain saw noise may damage your hearing. Always wear sound barriers (ear plugs or ear muffers) to protect your hearing.
	Wear Head Protection	Wear an approved safety hard hat to protect your head.
	Wear Protective Gloves	Protect your hands with gloves when handling saw and saw chain. Heavy-duty, nonslip gloves improve your grip and protect your hands.

	<p>Be aware of kickback</p>	<p>Contact of the guide bar tip with any object should be avoided</p>
	<p>Guide bar tip kickback</p>	<p>Tip contact can cause the guide bar to move suddenly upward and backward, which can cause serious injury.</p>
	<p>Two handed hold</p>	<p>Always use two hands when operating the chain saw</p>
	<p>Do not expose to rain</p>	<p>Do not expose to rain</p>
	<p>Recycle Symbols</p>	<p>This product uses lithium-ion (Li-ion) batteries. Local, state, or federal laws may prohibit disposal of batteries in ordinary trash. Consult your local waste authority for information regarding available recycling and/ or disposal options.</p>
	<p>Charging/Store the battery pack</p>	<p>Charging and Store the battery pack only in dry rooms with an ambient temperature of 50°F to 104°F (+10°C to +40°C).</p>
<p>V</p>	<p>Volt</p>	<p>Voltage</p>
<p>A</p>	<p>Amperes</p>	<p>Current</p>
<p>Hz</p>	<p>Hertz</p>	<p>Frequency (cycles per second)</p>

W	Watt	Power
min	Minutes	Time
	Alternating Current	Type of current
 	Direct Current	Type or a characteristic of current
$n_0$	No Load Speed	Rotational speed, at no load
... /min	Per Minute	Revolutions per minute



**⚠ DANGER:** People with electronic devices, such as pacemakers, should consult their physician(s) before using this product. Operation of electrical equipment in close proximity to a heart pacemaker could cause interference or failure of the pacemaker.

## GENERAL POWER TOOL SAFETY WARNINGS

**⚠ WARNING!** Read all safety warnings and instructions. Failure to follow the warnings and instructions may result in electric shock, fire and/or serious injury.

### **Save all warnings and instructions for future reference.**

The term “powertool” in the warnings refers to your mains-operated (corded) power tool or battery-operated (cordless) power tool.

## WORK AREA SAFETY

- **Keep work area clean and well lit.** Cluttered or dark areas invite accidents.
- **Do not operate power tools in explosive atmospheres, such as in the presence of flammable liquids, gases or dust.** Power tools create sparks which may ignite the dust or fumes.
- **Keep children and bystanders away while operating a power tool.**

Distractions can cause you to lose control.

## ELECTRICAL SAFETY

- **Power tool plugs must match the outlet. Never modify the plug in any way. Do not use any adaptor plugs with earthed (grounded) power tools.** Unmodified plugs and matching outlets will reduce risk of electric shock
- **Avoid body contact with earthed or grounded surfaces, such as pipes, radiators, ranges and refrigerators.** There is an increased risk of electric shock if your body is earthed or grounded.

- **Do not expose power tools to rain or wet conditions.** Water entering a power tool will increase the risk of electric shock.
- **Do not abuse the cord. Never use the cord for carrying, pulling or unplugging the power tool. Keep cord away from heat, oil, sharp edges or moving parts.** Damaged or entangled cords increase the risk of electric shock.
- **When operating a power tool outdoors, use an extension cord suitable for outdoor use.** Use of a cord suitable for outdoor use reduces the risk of electric shock.
- **If operating a power tool in a damp location is unavoidable, use a Ground-fault circuit interrupter protected supply.** Use of GFCI reduces the risk of electric shock.

## PERSONAL SAFETY

- **Stay alert, watch what you are doing and use common sense when operating a power tool. Do not use a power tool while you are tired or under the influence of drugs, alcohol, or medication.** A moment of inattention while operating power tools may result in serious personal injury.
- **Use personal protective equipment. Always wear eye protection.**  
Protective equipment such as dust mask, non-skid safety shoes, hard hat, or hearing protection used for appropriate conditions will reduce personal injuries.
- **Prevent unintentional starting. Ensure that the switch is in the off-position before connecting to power source and/or battery pack, picking up or carrying the tool.** Carrying power tools with your finger on the switch or energizing power tools that have the switch on invites accidents.
- **Remove any adjusting key or wrench before turning the power tool on.**  
A wrench or a key left attached to a rotating part of the power tool may result in

personal injury.

- **Do not overreach. Keep proper footing and balance at all times.** This enables better control of the power tool in unexpected situations.
- **Dress properly. Do not wear loose clothing or jewelry. Keep your hair, clothing and gloves away from moving parts.** Loose clothes, jewelry or long hair can be caught in moving parts.
- **If devices are provided for the connection of dust extraction and collection facilities, ensure that these are connected and properly used.** Use of dust devices can reduce dust-related hazards.

## POWERTOOL USE AND CARE

- **Do not force the power tool. Use the correct power tool for your application.** The correct power tool will do the job better and safer at the rate for which it was designed.
- **Do not use the power tool if the switch does not turn it on and off.** Any power tool that cannot be controlled with the switch is dangerous and must be repaired.
- **Disconnect the plug from the power source and/or the battery pack from the power tool before making any adjustments, changing accessories, or storing power tools.** Such preventive safety measures reduce the risk of starting the power tool accidentally.
- **Store idle power tools out of the reach of children and do not allow persons unfamiliar with the power tool or these instructions to operate the power tool.** Power tools are dangerous in the hands of untrained users.
- **Maintain power tools. Check for misalignment or binding of moving parts, breakage of parts and any other condition that may affect the**

**power tool's operation. If damaged, have the power tool repaired before use.** Many accidents are caused by poorly maintained power tools.

- **Keep cutting tools sharp and clean.** Properly maintained cutting tools with sharp cutting edges are less likely to bind and are easier to control.
- **Use the power tool, accessories and tool bits, etc. in accordance with these instructions, taking into account the working conditions and the work to be performed.** Use of the power tool for operations different from those intended could result in a hazardous situation.

## BATTERY TOOL USE AND CARE

- **Recharge only with the charger specified by the manufacturer.** A charger that is suitable for one type of battery pack may create a risk of fire when used with another battery pack.
- **Use battery operated chain saws only with specifically designated battery packs.** Use of any other battery packs may create a risk of injury and fire.
- **When the battery pack is not in use, keep it away from other metal objects, like paper clips, coins, keys, nails, screws or other small metal objects that can make a connection from one terminal to another.**

Shorting the battery terminals together may cause burns or a fire.

- **Under abusive conditions, liquid may be ejected from the battery; avoid contact. If contact accidentally occurs, flush with water. If liquid contacts eyes, additionally seek medical help.** Liquid ejected from the battery may cause irritation or burns.
- **Battery powered chain saws do not have to be plugged into an electrical outlet; therefore, they are always in operating condition. Be aware of possible hazards when not using your battery powered chain saws or when changing accessories. Following this rule will reduce the risk of electric shock, fire, or serious personal injury.**
- **Do not charge the battery pack outdoors.**

- Use only the charger supplied by the manufacturer to recharge.
- **Do not leave chain saws unattended when the battery is inserted.**  
Remove the battery when the chainsaw is not in use and before servicing.
- **Do not use to pick up flammable or combustible liquids, such as gasoline, or use in areas where they may be present.**
- **Do not operate chain saws in explosive atmospheres, such as in the presence of flammable liquids, gases, or dust.**

■

## SERVICE

- **Have your power tool serviced by a qualified repair person using only identical replacement parts.** This will ensure that the safety of the power tool is maintained.

**⚠ WARNING!** – that the vibration emission during actual use of the power tool can differ from the declared total value depending on the ways in which the tool is used.

**⚠ WARNING!** – and of the need to identify safety measures to protect the operator that are based on an estimation of exposure in the actual conditions of use (taking account of all parts of the operating cycle such as the times when the tool is switched off and when it is running idle in addition to the trigger time).

## CHAIN SAW SAFETY WARNINGS

- **Keep all parts of the body away from the saw chain when the chain saw is operating. Before you start the chain saw, make sure that the saw chain is not contacting anything.** A moment of inattention while operating chain saws may cause entanglement of your clothing or body with the chain.
- **Always hold the chain saw with your right hand on the rear handle and your left hand on the front handle.** Holding the chain saw with a reversed hand configuration increases the risk of personal injury and should never be done.

- **Hold the power tool by insulated gripping surfaces only, because the saw chain may contact hidden wiring.** Saw chains contacting a “live” wire may make exposed metal parts of the power tool “live” and could give the operator an electric shock.
- **Wear safety glasses and hearing protection. Further protective equipment for head, hands, legs and feet is recommended.** Adequate protective clothing will reduce personal injury by flying debris or accidental contact with the saw chain.
- **Do not operate a chain saw in a tree.** Operation of a chain saw while up in a tree may result in personal injury.
- **Always keep proper footing and operate the chain saw only when standing on fixed, secure and level surface.** Slippery or unstable surfaces such as ladders may cause a loss of balance or control of the chain saw.
- **When cutting a limb that is under tension be alert for spring back.** When the tension in the wood fibers is released the spring loaded limb may strike the operator and/or throw the chain saw out of control.
- **Use extreme caution when cutting brush and saplings.** The slender material may catch the saw chain and be whipped toward you or pull you off balance.
- **Carry the chain saw by the front handle with the chain saw switched off and away from your body. When transporting or storing the chain saw always fit the guide bar cover.** Proper handling of the chain saw will reduce the likelihood of accidental contact with the moving saw chain.
- **Follow instructions for lubricating, chain tensioning and changing accessories.** Improperly tensioned or lubricated chain may either break or increase the chance for kickback.
- **Keep handles dry, clean, and free from oil and grease.** Greasy, oily handles are slippery and cause loss of control.

- **Cut wood only. Do not use chain saw for purposes not intended. For example: do not use chain saw for cutting plastic, masonry or non-wood building materials.** Use of the chain saw for operations different than intended could result in a hazardous situation.

## **ADDITIONAL WARNINGS**

- **A chain saw is intended for two-handed use.** Serious injury to the operator, helpers, and/or bystanders can result from one-handed operation.
- **Avoid unintentional contact with the stationary saw chain or guide bar rails.** These can be very sharp. Always wear gloves and long pants or chaps when handling the chain saw, saw chain, or guide bar.
- **Never operate a chain saw that is damaged or improperly adjusted or that is not completely and securely assembled.** Be sure that the saw chain stops moving when the trigger switch is released.
- **Inspect the work piece for nails, wire, or other foreign objects prior to cutting.**
- **When bucking, secure the work piece prior to cutting. When felling or pruning, identify and secure hazardous branches.**
- **Aggressive or abusive cutting or misuse of the chain saw can cause premature bar, chain, and/or sprocket wear, as well as a broken chain or bar, leading to kickback, chain throw or the ejection of material.**
- **Never use the guide bar as a lever.** A bent guide bar can cause premature bar, chain, and/or sprocket wear, as well as a broken chain or bar, leading to kickback, chain throw or the ejection of material.
- **Cut only one work piece at a time.**
- **Use only with the battery packs and chargers listed below:**

BATTERY PACK	CHARGER
A40B25B01,A40B50B01, A40B75B01	A40KC400B01 A40MC100B01(XVE129- 4200300)

- **Do not charge the battery pack in rain or in wet locations.**
- **Plan the work, ensuring an obstacle-free work area and, in the case of felling, at least one escape path from the falling tree.**
- **When felling, keep bystanders at least two tree lengths away.**
- **If situations occur which are not covered in this manual, use care and good judgment. Contact HENX Customer Service for assistance.**



## CAUSES AND OPERATOR PREVENTION OF KICKBACK (Fig. 1, 2, 3 & 4)

Kickback may occur when the nose or tip of the guide bar touches an object, or when the wood closes in and pinches the saw chain in the cut.

Tip contact in some cases may cause a sudden reverse reaction, kicking the guide bar up and back towards the operator.

Pinching the saw chain along the top of the guide bar may push the guide bar rapidly back towards the operator.

Either of these reactions may cause you to lose control of the saw, which could result in serious personal injury. Do not rely exclusively upon the safety devices built into your saw.

As a chain saw user, you should take several steps to keep your cutting jobs free from accident or injury.

Kickback is the result of tool misuse and/or incorrect operating procedures or conditions and can be avoided by taking proper precautions as given below:

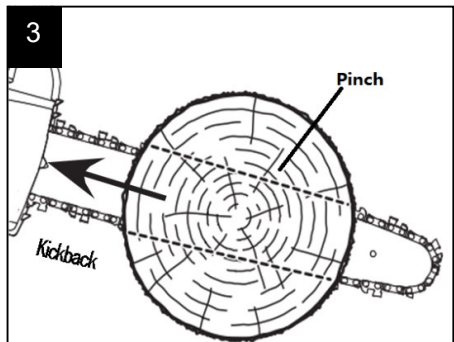
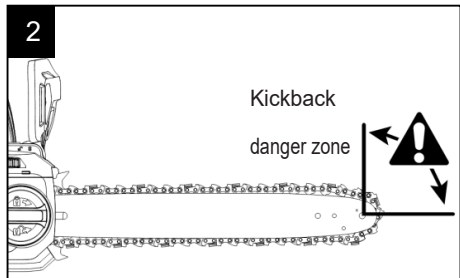
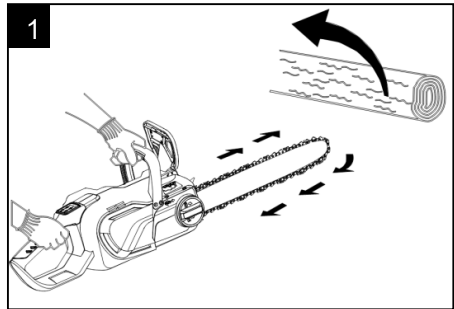

- **Maintain a firm grip, with thumbs and fingers encircling the chain saw handles, with both hands on the saw and position your body and arm to allow you to resist kickback forces (Fig. 4).** Kickback forces can be controlled by the operator, if proper precautions are taken. Do not let go of the chain saw.

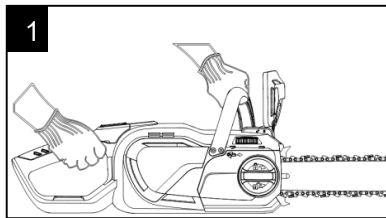

- **Do not overreach and do not cut above shoulder height.** This helps prevent unintended tip contact and enables better control of the chain saw in unexpected situations.
- **Only use replacement bars and chains specified by the manufacturer.** Incorrect replacement bars and chains may cause chain breakage and/or kickback.
- **Follow the manufacturer's sharpening and maintenance instructions for the saw chain.** Decreasing the depth gauge height can lead to increased kickback.
- **Make sure that the area in which you are cutting is free from obstructions.** Do not let the nose of the guide bar contact a log, branch, fence, or any other obstruction that could be hit while you are operating the saw.
- **Always cut with the unit running at full speed.** Fully squeeze the switch trigger and maintain cutting speed.
- **With a basic understanding of kickback, you can reduce or eliminate the element of surprise.** Sudden surprise contributes to accidents.
- **Keep proper footing and balance at all times.**

**When users find it's difficult to cut the hard tree or timber, they shall not force the chain saw to do cutting work by restarting it frequently.**

■

- Push and Pull** – The reaction force is always opposite to the direction the chain is moving where wood contact is made. Thus, the operator must be ready to control the PULL when cutting on the bottom edge of the bar, and the PUSH when cutting along the top edge. See Figure 5.

## KICKBACK SAFETY DEVICES ON THIS CHAIN SAW

### Chain Brake

The chain saw comes equipped with a chain brake, which stops both the

motor and the motion of the chain when kickback occurs. The chain brake can be activated by the forward motion of the chain kickback brake handle as the saw rotates backward during kickback; it can

also be activated by the inertial forces generated during rapid pushback.

**⚠ WARNING:** Never modify or attempt to disable the chain brake.

Make sure that the chain brake is working properly before using the chain saw. The chain kickback brake handle should move back and forth easily.

To test the operation of the chain brake, perform the following steps (Fig. 6):

- Place the chain saw on a flat bare

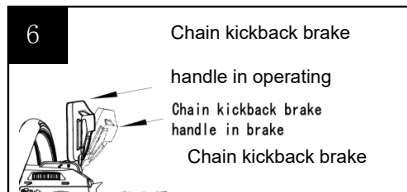
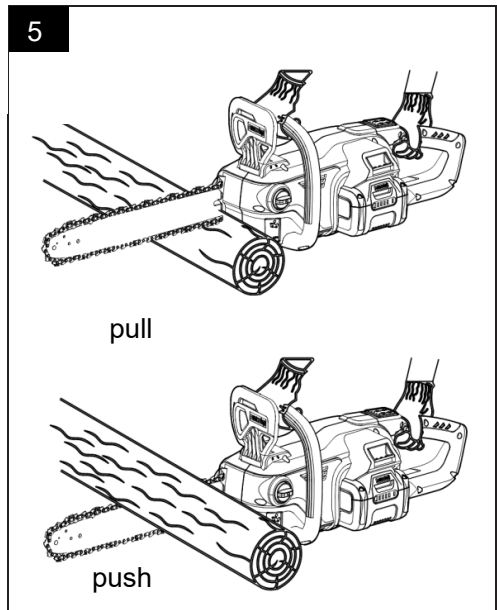

surface and make sure no objects or obstructions that could come in contact with the bar and chain are in the immediate vicinity.

- Disengage the chain brake by pulling the chain kickback brake handle towards the front handle.

- Start the chain saw.
- Push the chain kickback brake handle towards the front of the saw. A properly functioning hand brake will stop the movement of the chain immediately. If the chain brake is not working properly, do not use the chain saw until it has been repaired by a qualified service technician.

**⚠ WARNING:** Confirm that the chain brake works properly before each use.

**⚠ WARNING:** If the chain brake is clogged with wood chips, the function of the chain brake may deteriorate. Always keep the device clean.

## Low Kickback Saw Chain

The rakers (depth gauges) ahead of each cutter can minimize the force of a kickback reaction by preventing the cutters from digging in too deeply at the kickback zone. Only use a replacement chain that is equivalent to the original chain or has been certified as a low kickback chain. A low kickback tooth saw chain is a chain that has met the kickback performance requirements.

**⚠ CAUTION:** As saw chains are sharpened during their useful life, they lose some of the low kickback qualities and extra caution should be used.

## GUIDE BAR

This saw comes equipped with a guide bar that has a small radius nose. Small radius noses generally have less potential for kickback. When replacing the guide bar, be sure to order the bar listed in this manual.

**SAVE THESE INSTRUCTIONS!**

## GLOSSARY OF TERMS

**Automatic Oiler:** A system that automatically lubricates the guide bar and saw chain.

**Bucking:** The process of cross-cutting a felled tree or log into lengths.

**Bucking Spikes:** The pointed tooth or teeth for use when felling or bucking to pivot the saw and maintain position while sawing.

**Chain Brake:** A device used to stop the saw chain immediately.

**Chain Saw Power Head:** A chain saw without the saw chain or guide bar.

**Drive Sprocket:** The toothed part that drives the saw chain.

**Felling:** The process of cutting down a tree.

**Felling Back Cut:** The final cut in a tree felling operation made on the opposite side of the tree from the notching undercut.

**Kickback:** The backward or upward motion, or both, of the guide bar, which occurs when the saw chain near the nose of the top area of the guide bar contacts any object, such as a log or branch, or when the wood closes in and pinches the saw chain in the cut.

**Low-Kickback Chain:** A chain that complies with the kickback performance requirements of ANSIB175.1 when tested on a representative sample of chain saws.

**Normal Cutting Position:** Those positions assumed in performing bucking and felling cuts.

**Notching Undercut:** A notch cut in a tree that directs the tree's fall.

**Reduced Kickback Guide Bar:** A guide bar that has been demonstrated to reduce kickback significantly.



# INTRODUCTION

Congratulations on your selection of a new generation of 40V Lithium-ion powered chain saw. It has been designed, engineered and manufactured to give you the best possible dependability and performance.

Should you experience any problem you cannot easily remedy, please contact HENX customer service center ~~-(866) 678-8989~~ [86-571-87248935](tel:866-678-8986).

This manual contains important information on to the safe assembly, operation and maintenance of your chain saw. Read it carefully before using the chain saw.

Keep this manual handy so you can refer to it at any time.

SERIAL NUMBER \_\_\_\_\_ DATE OF PURCHASE \_\_\_\_\_

YOU SHOULD RECORD BOTH SERIAL NUMBER AND DATE OF PURCHASE AND KEEP IN A SAFE PLACE FOR FUTURE REFERENCE

# SPECIFICATIONS

Voltage	40V DC
Guide Bar Length	14-inch / 16-inch
Chain Pitch	3/8" (9.5mm)
Chain Gauge	0.043" (1.1mm)
Chain Type	90PX052X / 90PX057X OREGON

Guide Bar Type	144SDEA041/164SDEA041 OREGON
Chain Oil Tank capacity	5 oz. (150 ml)
Weight(Without battery pack, chain sheath)	8.15 lb. (3.7Kg)
LpA	84.5dB(A),K=3.
LwA measured	95.5dB(A),K=3.
LwA guranteed	99dB(A)
Vibration	2.18m/s <sup>2</sup> ,K=1.5m/s <sup>2</sup> .

Battery	Lithium-Ion		
Models	A40B75B01	A40B50B01	A40B25B01
voltage	40 VDC	40 VDC	40 VDC
Capacity	7.5Ah	5.0Ah	2.5Ah
Model(charger)	A40KC400B01		
Input	120VAC 60Hz, 400W		
Output	40VDC, 8A		
Allowable charge temperature range	0 - 40 °C		
Model(charger)	A40MC100B01(XVE129-4200300)		
Input	100-120VAC, 50/60Hz, 2.5A Max;		

Output	42.0VDC, 3A
Allowable charge temperature range	0 - 40 °C

### Recommended Bar and Chain for this Chain Saw

PART NAME	TYPE/14inch	TYPE/16inch
Guide bar	140SDEA041 (OREGON)	160SDEA041(OREGON) 164MLEA041(OREGON)
Saw chain	91P052X (OREGON)	91P057X(OREGON) 90PX056X(OREGON)

## PACKING LIST

PART NAME	QUANTITY
Chain Saw	1
Chain sheath	1
Oregon Chain	1
Oregon Guide Bar	1
Operator's manual	1
Slotted screwdriver	1

# DESCRIPTION

## KNOW YOUR CHAIN SAW (Fig. 7)

The safe use of this product requires an understanding of the information on the tool and in this operator's manual, as well as knowledge of the project you are attempting. Before use of this product, familiarize yourself with all operating features and safety rules.

### Chain Kickback Brake Handle

7	Chain Kickback Brake Handle	Front Handle	Lock-off Button
---	-----------------------------	--------------	-----------------

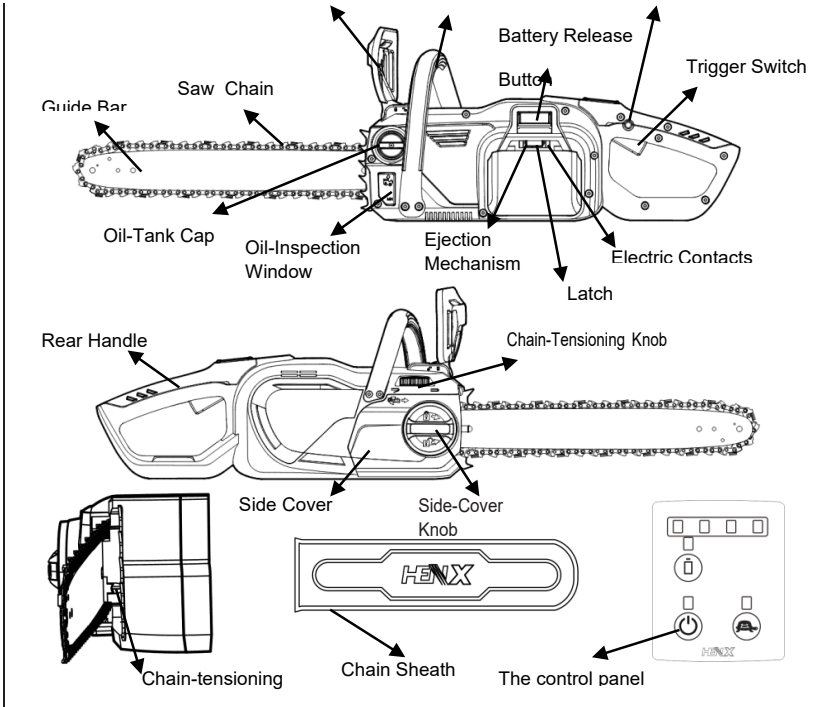

Serves as the lever for chain brake activation. It also provides protection against projecting branches and helps prevent the left hand from touching the saw chain if it slips off the front handle.

## **Trigger Switch**

Turns the chain saw On and Off.

## **Lock-off Button**

Helps to prevent accidental or unauthorized activating of the trigger switch. It must be depressed before the trigger switch can be activated.

## **Oil-Tank Cap**

Seals the oil tank.

## **Oil-Inspection Window**

Provides a view the oil level.

## **Guide Bar**

Supports and guides the saw chain.

## **Chain Sheath**

The chain sheath keeps the operator from coming in contact with the sharp chain blades when the tool is not in use. It also helps keep the chain blades from being nicked or damaged when the tool is in transportation and storage.

## **Saw Chain**

A loop of chain having cutting teeth that cut the wood when it is driven by the power- head and supported by the guide bar.

## **Front Handle**

The support handle for the left hand at the front of the saw.

## **Rear Handle**

The support handle for the right hand, located at the rear of the saw

### **Chain-Tensioning Knob**

Permits precise adjustment of chain tension.

### **Chain-Tensioning Screw**

Permits precise adjustment of the chain tension with a manual slotted screwdriver.

### **Side Cover**

Covers the chain sprocket and secures the guide bar

### **Side-Cover Knob**

Locks/unlocks the side cover

### **Battery-Release Button**

Press to release the battery pack from the tool.

### **Latch**

Locks the battery pack in place when it is installed on the tool.

### **Ejection Mechanism**

Aids in removing the battery.



## **Mounting Slot**

Guides the battery pack.

# ASSEMBLY

**⚠ WARNING:** If any parts are damaged or missing, do not operate this product until those parts are replaced. Use of this product with damaged or missing parts could result in serious personal injury.

**⚠ WARNING:** Do not attempt to modify this product or create accessories not recommended for use with this chain saw. Any such alteration or modification is misuse and could result in a hazardous condition leading to possible serious personal injury.

**⚠ WARNING:** To prevent accidental starting that could cause serious personal injury, always remove the battery pack from the tool when assembling parts.

## UNPACKING

This product has been shipped completely assembled.

- Carefully remove the product and any accessories from the box. Make sure that all items listed in the packing list are included.
- Inspect the tool carefully to make sure no breakage or damage occurred during shipping.
- Do not discard the packing material until you have carefully inspected and satisfactorily operated the tool.
- If any parts are damaged or missing, please contact HENX Customer Service for assistance.

# OPERATION

**NOTICE:** Recommended ambient temperature: 0-40 degree centigrade.

**⚠ WARNING:** Do not allow familiarity with this product to make you careless. Remember that a careless fraction of a second is sufficient to inflict serious injury.

**⚠ WARNING:** Always wear eye protection with side shields marked to comply with ANSI Z87.1, along with hearing protection. Failure to do so could result in objects being thrown into your eyes and other possible serious injuries.

**⚠ WARNING:** Do not use any attachments or accessories not recommended by the manufacturer of this product. The use of attachments or accessories not recommended can result in serious personal injury.

Before each use, inspect the entire product for damaged, missing, or loose parts, such as screws, nuts, bolts, caps, etc. Securely tighten all fasteners and caps and do not operate this product until all missing or damaged parts are replaced.

## APPLICATION

You may use this product for basic felling, limbing, pruning and wood cutting of lumber and trees.

## FILLING OIL TANK WITH BAR AND CHAIN LUBRICANT

**⚠ WARNING:** To prevent accidental starting that could cause serious personal injury, always remove the battery pack from the tool before filling the tank with oil.

**⚠ WARNING:** Do not smoke or bring any fire or flame near the oil or the chain saw. Oil may spill and cause a fire.

**NOTICE:** The chain saw is not filled with oil at the time of purchase. It is essential to fill the tank with o

il before use. Operating the chain saw without chain oil or when the oil level is below the minimum mark will result in damage to the chain saw. Chain life and cutting capacity depend on optimum lubrication. The chain is automatically lubricated with chain oil during operation.

1. Remove the battery pack from the chain saw.
2. Clean the oil tank cap and the area around it to ensure that no dirt falls into the oil tank.

3. Position the chain saw on its side on a firm, flat surface, so that the tank cap is facing upwards. Rotate the oil tank cap counterclockwise to remove it (Fig. 8).

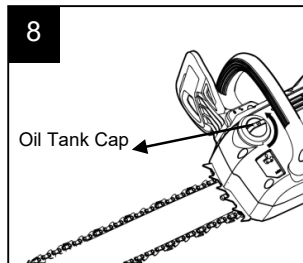

4. Carefully pour the bar and chain oil into the tank. The filter in the opening allows the oil to seep slowly into the tank; be careful not to let the oil spill from the opening. Fill to the bottom of the fill neck. Wipe off any excess oil.

5. Replace the cap, place the saw upright, and view the level through the oil inspection window. Oil should fill the window.

## NOTICE:

- Use Oregon Chain and Bar oil for best results. It is specially designed to provide low friction and faster cuts.
- Never use oil or other lubricants not specifically designed for use on the bar and chain. This can lead to a clogged oil system, which may cause premature wear of the bar and chain.
- Check the oil level frequently and fill when the oil level falls below the minimum line. Never operate the chain saw if the oil is not visible.
- Do not use dirty, used or otherwise contaminated oils. Damage may occur to the bar or chain.
- There is a filter inserted in the opening of the oil tank to filter out dirt and debris.

**DO NOT** remove the filter when filling the oil tank.

- It is normal for oil to seep from the saw when it is not in use. To prevent seepage, empty the oil tank after each use, and then run the saw for one minute. When storing the tool for a long period of time, be sure the chain is lightly lubricated; this will prevent rust on the chain and bar sprocket.
- To preserve natural resources, please recycle or dispose of oil properly. Consult your local waste authority for information regarding available recycling and disposal options.

## TO INSTALL/REMOVE BATTERY PACK (Fig. 9 & 10)

**NOTICE:** Fully charge the battery pack before its first use.

### To Install (Fig. 9)

1. Align the ribs of the battery pack with the mounting slots in the chain saw's battery port.
2. Slide the battery pack into the tool until it snaps into position.

**NOTICE:** Make sure that the latch on the chain saw snaps into place and the battery pack is secured to the tool before beginning operation.

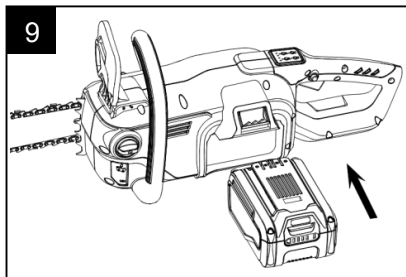

### To Remove (Fig. 10)

**⚠ WARNING:** Always be aware of the location of your feet, children, or pets when pressing the battery-release button. Serious injury could result if the battery pack falls. **NEVER** remove the battery pack at a high location.

1. Hold the battery pack in the palm of your hand.
2. Press the battery release button with your thumb; the battery pack will disengage from the latch.
3. Grasp the battery pack and remove it from the chain saw.

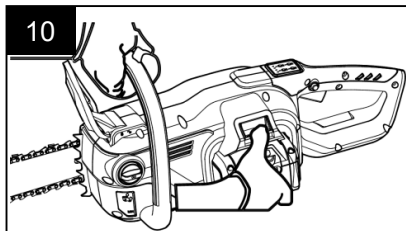

## **STARTING/STOPPING THE CHAIN SAW**

### **Before Starting the Chain Saw:**

1. Remove the battery pack.
2. Make sure that the chain is properly mounted and correctly tensioned.
3. Lift the tip of the guide bar up to check for any sagging in the chain. The chain is correctly tensioned when there is no sag on the underside of the guide bar and the chain is snug, but it can be turned by hand without binding. If the tension requires adjustment, refer to the section: "REPLACING THE BAR AND CHAIN" in the Maintenance section of this manual for adjustment instructions.
4. Check the tension of the side-cover knob before use. If it is loose, securely tighten the side-cover knob by turning it clockwise.
5. Check the oil level and fill the tank as needed.
6. Check the cutting teeth sharpness of the saw chain.
7. Make sure the chain is well lubricated.
8. Make sure the chain kickback brake handle moves easily to the brake position, then pull the chain kickback brake handle back towards the front handle to the operating position.
9. Stand upright and hold the chain saw in a relaxed position.
10. Make sure the saw chain is not touching the ground or any other objects.
11. Hold the chain saw with both hands: with the right hand on the rear handle and the left hand on the front handle.
12. Make sure that you have a secure and balanced footing. Watch out for obstacles such as tree stumps, roots and ditches, which could cause you to trip or stumble.



## To Start the Chain Saw (Fig. 11)

1. Install the battery pack.
2. Make sure no objects or obstructions are in the immediate vicinity which could come in contact with the bar and chain.
3. Pull the chain kickback brake handle towards the front handle to the operating position (Fig. 6).
4. Grasp the front and rear handles firmly, using both hands.
5. Press and hold the lock-off button with the thumb of your right hand, then squeeze the trigger switch with the fingers of your right hand to start the saw. Release the lock-off button and continue to squeeze the trigger for continued operation.

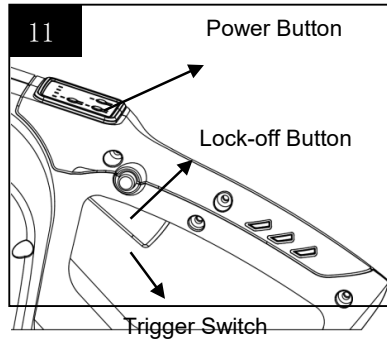

**⚠ WARNING:** Do not attempt to start the saw when the saw chain is in a cut.

## To Stop the Chain Saw

1. Move the chain saw away from cutting area, and then release the trigger switch to stop the chain saw.
2. Push the chain kickback brake handle forward to the brake position to engage the chain brake (Fig. 6).

**⚠ WARNING:** Always remove the battery pack from the chain saw during work breaks and after finishing work.

## PREPARATION FOR CUTTING

Refer to “Important Safety Instructions” earlier in this manual for appropriate safety equipment.

### Work Area Precautions

- Cut only wood or materials made from wood; do not cut sheet metal, plastics, masonry, or non-wood building materials.
- Never allow children to operate the chain saw.
- Allow no person to use this chain saw who has not read this Operator's Manual or received adequate instructions for the safe and proper use of this chain saw.
- When felling a tree, keep everyone - helpers, bystanders, children, and animals - a safe distance from the cutting area. During felling operations, the safe distance should be a least twice the height of the largest trees in the felling area. During bucking operations, keep a minimum distance of 15 feet (4.5 m) between workers. Trees should not be felled in a manner that would endanger any person, strike any utility line or cause any property damage. If a tree does make contact with any utility line, stay clear of the tree and the line and notify the utility company immediately.
- Always cut with both feet on solid ground to prevent being pulled off balance.
- Do not cut above chest height, as a saw held higher is difficult to control against kickback forces.
- Do not fell trees near electrical wires or buildings.
- Cut only when visibility and light are adequate for you to see clearly.

## Proper Grip On Handles

- Wear non-slip gloves for maximum grip and protection.
- With the saw on a firm, flat surface, hold the saw firmly with both hands.
- Always grasp the front handle with the left hand and the rear handle with the right hand.
- The fingers should encircle the handle, with the thumb wrapped under the front handle (Fig. 12).

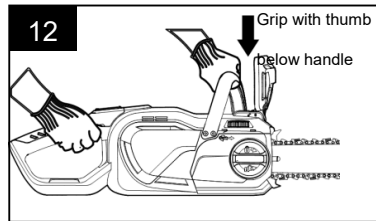

**⚠ WARNING:** Never use a left-handed (cross-handed) grip, or any stance which would place your body or arm across the chain line.

**⚠ WARNING:** Do not operate the trigger switch with your left hand and hold the front handle with your right hand. Never allow any part of your body to be in the chain line while operating a chain saw (Fig. 13).

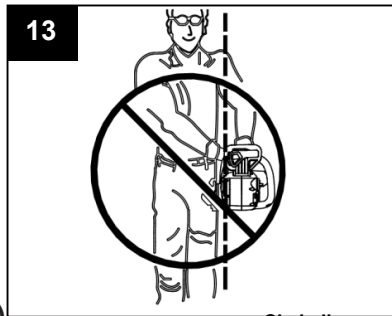

### Proper Cutting Stance (Fig. 14)

- Both feet should be on solid ground, with weight evenly spread between them.
- The left arm should be straight, with the elbow locked. This helps to withstand the forces generated by kickback.
- Your body should always be to the left of the chain line.

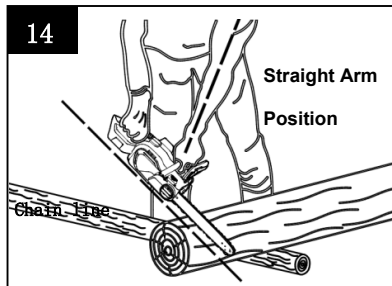

## CUTTING

### Basic Cutting

**⚠ WARNING:** Always be sure of your footing and hold the chain saw firmly with both hands while the motor is running.

Practice cutting a few small logs using the following technique to get the “feel” of using your saw before you begin a major sawing operation.

1. Take the proper stance in front of the wood with the saw off.
2. Press the lock-off button and squeeze the trigger to start the chain saw. Let the chain reach the full speed before beginning the cut.
3. Begin cutting by lightly pressing the guide bar against the wood. Use only light pressure, letting the saw do the work.
4. Maintain a steady speed throughout the cut, releasing pressure just before the end of the cut.
5. Release the trigger as soon as the cut is completed, allowing the chain to stop.

**⚠ WARNING:** When the saw chain is stopped due to pinching during cutting, release the trigger switch; remove the saw chain and guide bar from the wood, then restart the chain saw.

**⚠ WARNING:** Do not pull the saw chain with your hand when it is bound by the sawdust. Serious injury could result if the chain saw starts accidentally. Press the saw chain against the wood, move the chain saw back and forth to discharge the debris. Always remove the battery pack before cleaning. Wear heavy protective gloves when handling the saw chain.

**⚠ WARNING:** Never start the chain saw when it is in contact with the wood. Always allow the chain saw reach full speed before applying the saw to the wood.

## FELLING A TREE

### Hazardous Conditions

**⚠ WARNING:** When felling a tree, it is important that you heed the following warnings to prevent possible serious injury.

- Do not fell trees during periods of high wind or heavy precipitation. Wait until the hazardous weather has ended.
- Do not fell trees that lean at extreme angles or large trees with rotten limbs, loose bark, or hollow trunks. Instead, have these trees pushed or dragged down with heavy equipment and then cut them up.
- Do not fell trees near electrical wires or buildings.
- Check the tree for damaged or dead branches that could fall and hit you during felling.
- Periodically glance at the top of the tree during the back cut to assure the tree is going to fall in the desired direction.
- If the tree starts to fall in the wrong direction, or if the saw gets caught or hung up during the fall, leave the saw and save yourself!

### Preparation For Tree Felling

- When bucking and felling operations are being performed by two or more persons at the same time, the felling operation should be separated from the bucking operation by a distance of at least twice the height of the tree being felled. Trees should not be felled in a manner that would endanger any person, strike any utility line or cause any property damage. If the tree does make contact with any utility line, the utility company should be notified immediately.
- The chain saw operator should stand on the uphill side of the terrain, as the tree

is likely to roll or slide downhill after it is felled.

- Before any cuts are started, pick your escape route (or routes, in case the intended route is blocked). Clear the immediate area around the tree and make sure that there are no obstructions in your planned paths of retreat. Clear a path of safe retreat approximately  $135^\circ$  from the planned line of fall. The retreat path should extend back and diagonally to the rear of the expected line of fall. See Figure 15.

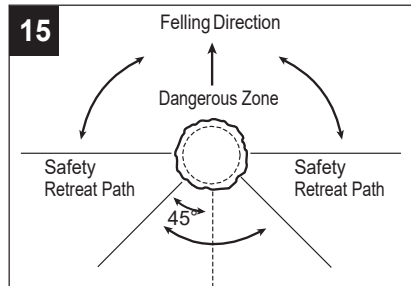

- Before felling is started, consider the natural lean of the tree, the location of larger branches and the wind direction to judge which way the tree will fall.
- Remove dirt, stones, loose bark, nails, staples, and wire from the tree where felling cuts are to be made.

## Notching undercut

Make the notch 1/3 the diameter of the tree, perpendicular to the direction of fall, as illustrated in Fig. 16. Make the lower horizontal notching cut first. This will help to avoid pinching of either the saw chain or the guide bar when the second notch is being made.

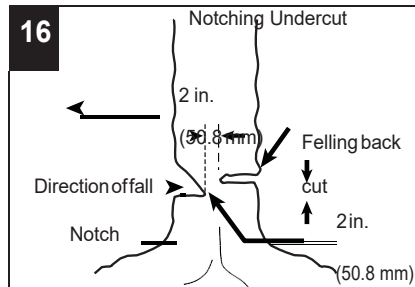

## Felling Back Cut

1. Make the felling back cut at least 2 inches (50.8 mm) higher than the horizontal notching cut (Fig. 16). Keep the felling back cut parallel to the horizontal notching cut. Make the felling back cut so that enough wood is left to act as a hinge. The hinge keeps the tree from twisting and falling in the wrong direction. Do not cut through the hinge.
2. As the felling cut gets close to the hinge, the tree should begin to fall. If there is any chance that the tree may not fall in the desired direction or it may rock back and bind the saw chain, stop cutting before the felling back cut is complete and use wedges of wood, plastic or aluminum to open the cut and drop the tree along the desired line of fall.
3. When the tree begins to fall, remove the chain saw from the cut, stop the motor, put the chain saw down, then use the retreat path planned. Be alert for overhead limbs falling and watch your footing.



## LIMBING

Limbing is removing branches from a fallen tree. When limbing, leave larger limbs to support the log off the ground. Remove the small limbs in one cut as illustrated in Fig. 17. Branches under tension should be cut from the bottom up to avoid binding the chain saw.

**⚠ WARNING:** There is an extreme

danger of kickback during the limbing operation. Be extremely cautious and avoid contacting the log or other limbs with the tip of the guide bar.

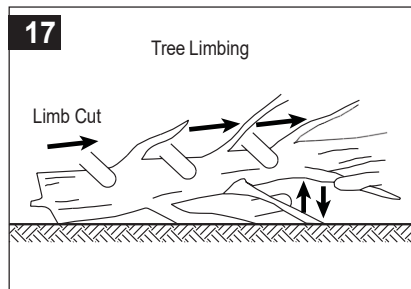

## BUCKING A LOG (Fig. 18):

Bucking is cutting a log into lengths. It is important to make sure your footing is firm and your weight is evenly distributed on both feet. When possible, the log should be raised and supported by the use of limbs, logs or chocks. Follow the simple directions for easy cutting.

**⚠ WARNING:** Keep a clear cutting area. Make sure that no objects can contact the guide bar nose and chain during cutting; this can cause kickback.

### Overbucking

Begin on the top side of the log with the

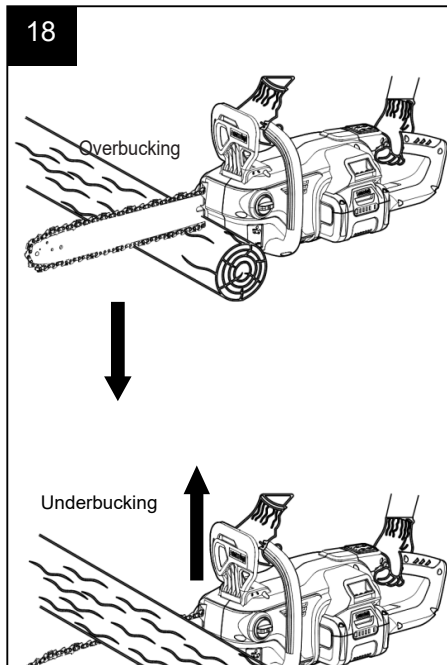

bottom of the saw against the log; exert light pressure downward. Note that the saw will tend to pull away from you.

## Underbucking

Begin on the underside of the log with the top of the saw against the log; exert light pressure upward. During underbucking, the saw will tend to push back at you. Be prepared for this reaction and hold the saw firmly to maintain control.

- When the log is supported along its entire length, it should be cut from the top (overbucking) (Fig. 19).
- When the log is supported on only one end, cut 1/3 the diameter from the underside (underbucking). Then make the finishing cut by overbucking to meet the first cut (Fig. 20).
- When the log is supported on both ends, cut 1/3 of that diameter from the top overbuck. Then make the finished cut by underbucking the lower 2/3 to meet the first cut (Fig. 21).

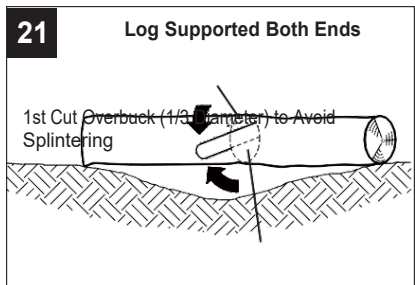
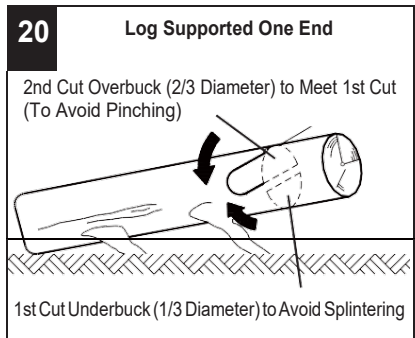
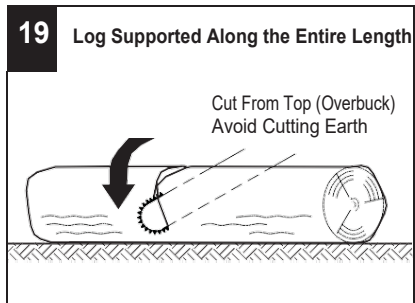

2nd Cut Underbuck (2/3 Diameter) to Meet  
1st Cut (To Avoid Pinching)

- When bucking on a slope, always stand on the uphill side of the log (Fig. 22).
- To maintain complete control when cutting through, release the cutting pressure near the end of the cut without relaxing the grip on the chain saw handles. Don't allow the chain to contact the ground. After completing the cut, wait for the saw chain to stop before you move the chain saw. Always stop the motor before moving from tree to tree.

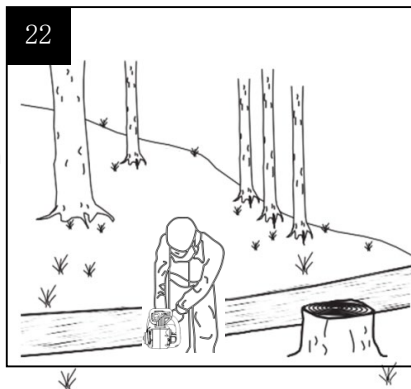

## MAINTENANCE

**⚠ WARNING:** When servicing, use only identical replacement parts. Use of any other parts may create a hazard or cause product damage.

**⚠ WARNING:** Always wear safety goggles or safety glasses with side shields during power tool operation or when blowing dust. If the operation is dusty, also wear a dust mask.

**⚠ WARNING:** To avoid serious personal injury, remove the battery pack from the chain saw before inspecting, cleaning, or performing maintenance. A battery operated tool with the battery pack inserted is always on and can start accidentally.

**⚠ WARNING:** When cleaning the chain saw, DONOT immerse in water or other liquids.

**⚠ WARNING:** Do not at any time let brake fluids, gasoline, petroleum-based products, penetrating oils, etc., come in contact with plastic parts. Chemicals can damage, weaken, or destroy plastic, which may result in serious personal injury.

## CLEANING

- After each use, clean debris from the chain and guide bar with a soft brush. Wipe the chain saw surface with a clean cloth moistened with a mild soap solution.
- Remove the side cover, and then use a soft brush to remove debris from the guide bar, saw chain, sprocket and side cover.
- Always clean out wood chips, saw dust, and dirt from the guide bar groove when replacing the saw chain.

## REPLACING THE BAR AND CHAIN

**⚠ WARNING:** Before performing any maintenance, make sure that the battery pack is removed. Failure to heed this warning could result in serious personal injury.

**⚠ WARNING:** Always wear gloves when handling the bar and chain; these components are sharp and may contain burrs.

**⚠ WARNING:** Never touch or adjust the chain while the motor is running. The saw chain is very sharp; always wear protective gloves when performing maintenance to the chain.

**NOTICE:** When replacing the guide bar and chain, always use the specified bar and chain combination listed in the later section: **“Recommended Bar and Chain for this Chain Saw”**.

### Disassembling the Worn Bar and Chain

1. Remove the battery, allow the saw to cool and tighten the oil tank cap.
2. Position the chain saw on its side on a firm, flat surface, so that the side cover is facing upwards (Fig. 23).
3. Wear gloves. Remove the side cover by turning the side cover knob counterclockwise (Fig. 23). Clean the side cover with a dry cloth.
4. Turn the chain-tensioning knob towards the front handle as far as it will go (Fig. 23). Remove the bar and chain from the mounting surface. Remove the worn chain from the bar.

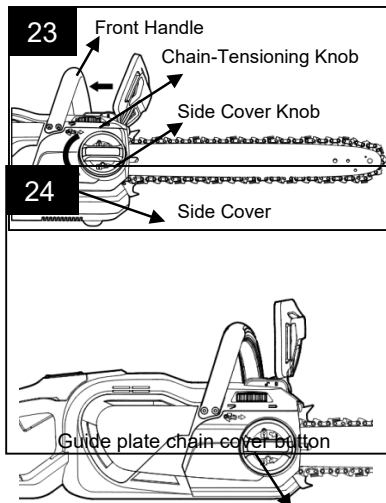

5. Guide plate chain cover can tie the plate clockwise, disassemble the plate anticlockwise. (Fig.24)

**NOTICE:** This is a good time to inspect the drive sprocket for excessive wear or damage.



## Assembling The New Bar and Chain

1. Remove the battery, allow the saw to cool and tighten the oil tank cap.
2. Lay the new saw chain in a loop on a flat surface and straighten any kinks (Fig. 25).
3. Place the chain drive links into the guide bar groove. Position the chain so there is a loop at the back of the guide bar (Fig. 26).
4. Hold the chain in position on the guide bar and place the loop around the sprocket of the power head.

**NOTICE:** Small directional arrows are engraved in the saw chain (Fig. 26a). Another directional arrow is molded into the housing (Fig. 26a). When looping

the saw chain onto the sprocket, make sure that the direction of the arrows on the saw chain will correspond to the direction of the arrow on the housing. If they face in opposite directions, turn over the saw chain and guide bar assembly (Fig. 26b.)

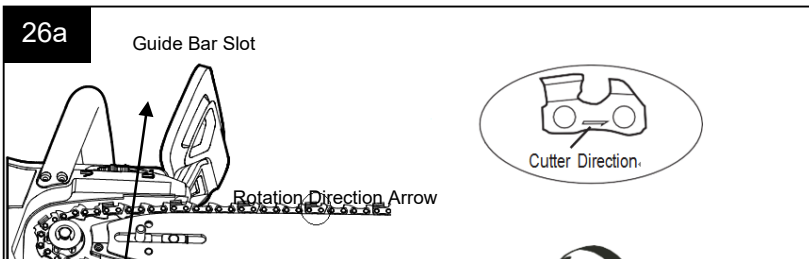
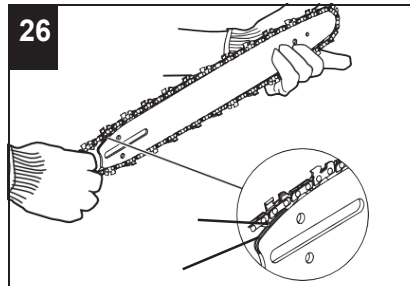
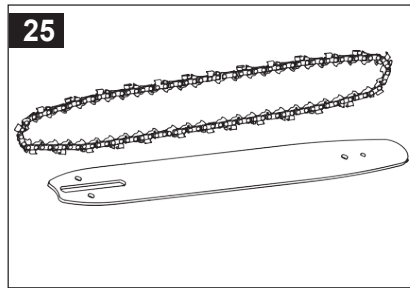

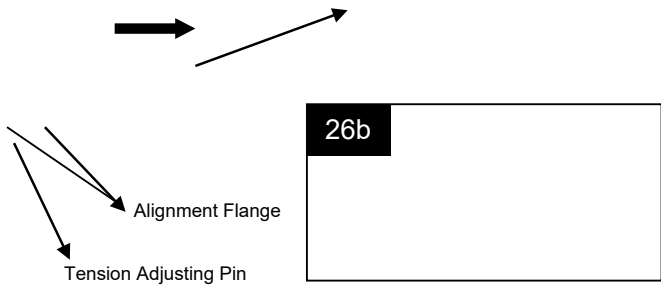

5. Place the guide bar on the mounting surface by sliding the guide bar slot over the alignment flanges, making sure that the tension adjusting pin is inserted in the lower hole in the tail of the bar (Fig. 26a).
6. Replace the side cover and lightly tighten the side cover knob by turning it clockwise. The bar must be free to move for tension adjustment.

**NOTICE:** To extend the guide bar life, invert the bar occasionally.

**⚠ CAUTION:** The saw chain must be properly tensioned before using.

7. Remove all the slack from the chain by turning the chain-tensioning knob clockwise until the chain seats snugly against the guide bar with the drive links in the guide bar groove.
8. Lift the tip of the guide bar up to check for sag (Fig. 27). Release the tip of the guide bar and turn the chain-tensioning knob once clockwise. Repeat this process until the sag is eliminated.
9. Hold the tip of the guide bar up and tighten the side cover knob securely. The chain is correctly tensioned when there is no sag on

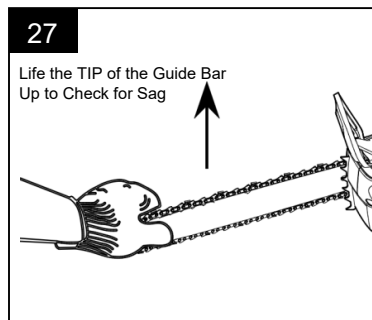

the underside of the guide bar and the chain is snug, but it can be turned by hand without binding.

**NOTICE:** If chain is too tight, it will not rotate. Loosen the side cover knob slightly and turn the tensioning knob once from right to left. Lift the tip of the guide bar up and retighten the side cover knob securely. Assure that the chain will rotate without binding.

## Adjusting The Chain Tension

1. Stop the motor and remove the battery pack before adjusting the chain tension.
  2. Loosen the side cover knob.
  3. Turn the chain-tensioning knob clockwise to tension the chain. See the section: "REPLACING THE BAR AND CHAIN" in this manual for additional information.
- A cold chain is correctly tensioned when there is no slack on the underside of the guide bar and the chain is snug, but it can be turned by hand without binding. The chain must be re-tensioned whenever the flats on the drive links do not sit in the bar groove.
  - During normal saw operation, the temperature of the chain will increase. The drive links of a correctly tensioned warm chain will hang approximately 0.04 in. (1.1 mm) out of the bar groove (Fig.28).

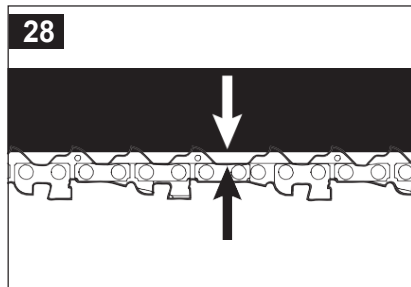

**NOTICE:** New chains tend to stretch; check chain tension frequently and tension as required.

**NOTICE:** A chain tensioned while it is

warm may be too tight upon cooling. Check the cold tension before next use.

## CHAIN MAINTENANCE

**⚠ WARNING:** Remove the battery pack before performing any maintenance; failure to heed this warning could result in serious personal injury.

**⚠ WARNING:** Always wear gloves when handling the saw chain; these components are sharp and may contain burrs.

Use only low-kickback chains on this saw. This fast cutting chain will provide kickback reduction when properly maintained.

A properly sharpened saw chain cuts through wood effortlessly, even with very little pressure.

Never use a dull or damaged saw chain. A dull saw chain cutter leads to increased physical strain, increased vibration load, unsatisfactory cutting results and increased wear.

For smooth and fast cutting, the chain needs to be maintained properly. The chain requires sharpening when the wood chips are small and powdery, the chain must be forced through the wood during cutting, or the chain cuts to one side. During maintenance of your chain, consider the following:

- Improper filing angle of the side plate can increase the risk of a severe kickback.
- Raker (depth gauge) clearance. Too low increases the potential for kickback. Not low enough decreases cutting ability.
- If cutter teeth have hit hard objects, such as nails and stones, or have been abraded by mud or sand on the wood, have the chain sharpened by a qualified service technician.

**NOTICE:** Inspect the drive sprocket for wear or damage when replacing the chain. If signs of wear or damage are present in the areas indicated,

have the drive sprocket replaced by qualified service technician.

## How To Sharpen The Cutters

Be careful to file all cutters (Fig. 29) to the specified angles and to the same length, as fast cutting can be obtained only when all cutters are uniform.

1. Remove the battery pack. Wear gloves for protection.
2. Properly tension the chain prior to sharpening. Refer to the

section: "ADJUSTING THE CHAIN TENSION" earlier in this manual.

3. Use a 0.177" (4.5 mm) diameter round file and holder (available separately). Do all of your filing at the middle position of the guide bar.
4. Keep the file level with the top plate of the tooth. Do not let the file dip or rock.
5. Keep a correct sharpening angle of 30° between the file and the saw chain; see Fig. 30 & 31. Always use a file holder (available separately) when sharpening saw chains by hand. File holders have markings for the sharpening angle.
6. Using light but firm pressure, stroke towards the front corner of the tooth. Lift the file away from the steel on each return stroke.

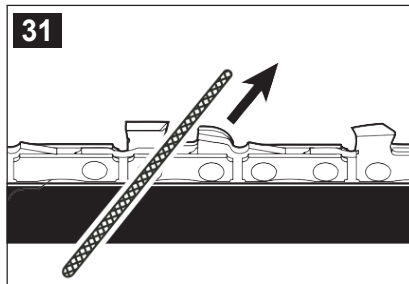
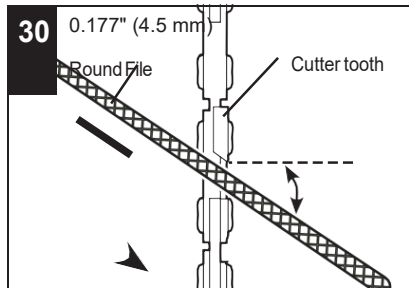
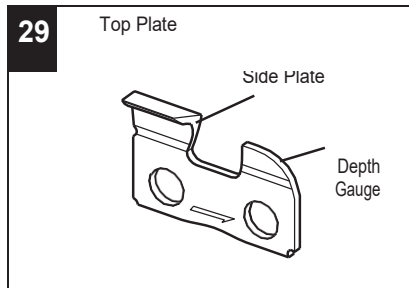

7. Make a few firm strokes on every tooth. File all left hand cutters in one direction. Then move to the other side and file the right hand cutters in the opposite direction. Occasionally remove filings from the file with a wire brush (Fig. 32).

**⚠ WARNING:** A dull or improperly sharpened chain can cause excessive motor speed during cutting, which may result in severe motor damage.

**⚠ WARNING:** Improper chain sharpening increases the potential of kickback.

**⚠ WARNING:** Failure to replace or repair a damaged chain can cause serious injury.

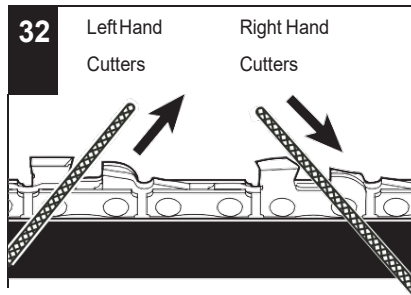

### Top Plate Sharpening Angles (Fig. 33)

- **CORRECT 30°** - This optimal angle can be obtained only when the specified files and proper setting are used. File holders are marked with guide marks to align the file properly to produce the correct top plate angle.

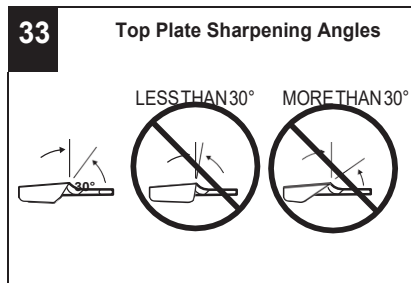

- **LESS THAN 30°** - The tooth is too dull for cutting.
- **MORE THAN 30°** - The edge of the cutting tooth is feathered and dulls quickly.



## Side Plate Angle (Fig. 34)

- CORRECT 55°**-The optimal angle can be produced automatically if the correct diameter file is used in the file holder.
- HOOK**- “Grabs” and dulls quickly.

Increases potential of KICKBACK. Results from using a file with a diameter that is too small, or a file held too low.

- BACKWARD SLOPE**- Needs too much feed pressure, causes excessive wear to bar and chain. Results from using a file with a diameter too large, or a file held too high.

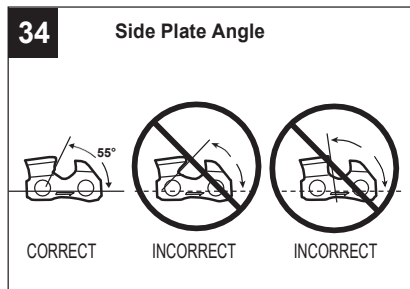

## Depth Gauge Clearance

- The depth gauge should be maintained at a clearance of 0.025 in. (0.6 mm), as shown in Fig. 35. Use a depth gauge tool (available separately) to check the depth gauge clearances.
- Check the depth gauge clearance every time the chain is filed.

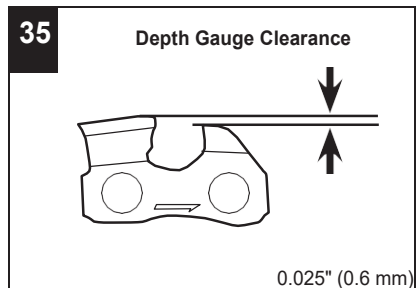

Use a flat file and a depth-gauge jointer (both available separately) to lower all gauges uniformly (Fig. 36). Depth-gauge jointers are available in 0.020 in. to 0.035 in. (0.5 mm to 0.9 mm). Use a

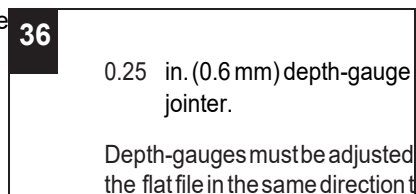

0.25 in. (0.6 mm) depth-gauge jointer.

Depth-gauges must be adjusted with the flat file in the same direction the

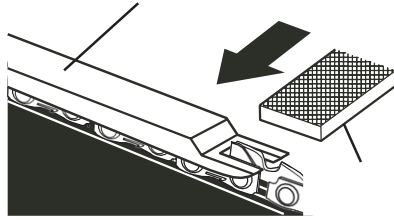

adjoining cutter was filed with the round file. Use

care not to contact the cutter face with the flat file when adjusting depth-gauges.

## GUIDE BAR MAINTENANCE

When the guide bar shows signs of wear, reverse it on the saw to distribute the wear for maximum bar life. The bar should be cleaned every day of use and checked for wear and damage. Feathering or burring of the bar rails is a normal process of bar wear. Such faults should be smoothed with a file as soon as they occur. A bar with any of the following faults should be replaced.

- Wear inside the bar rails which permits the chain to lay over sideways.
- Bent guide bar.
- Cracked or broken rails.
- Spread rails.

In addition, the guide bar has a sprocket at its tip. The sprocket must be lubricated weekly with a grease syringe to extend the guide bar life. Use a grease syringe to

lubricate weekly with chain oil by means of the lubricating hole (Fig. 37). Turn the guide bar and check that the lubrication holes and chain groove are free from impurities.

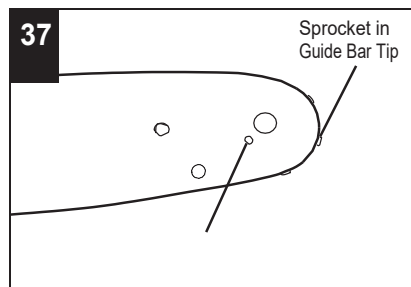

## Reversing The Guide Bar

1. Remove the guide bar and chain from the chain saw, following the section: "REPLACING THE BAR AND CHAIN".
2. Remove the chain from the guide bar and turn the guide bar over (Fig. 38). The bottom of the bar will be on the top.
3. Replace the chain on the bar.
4. Reassemble the guide bar and chain on the chain saw and adjust the chain tension, following the section: "REPLACING THE BAR AND CHAIN" and "ADJUSTING THE CHAIN TENSION".

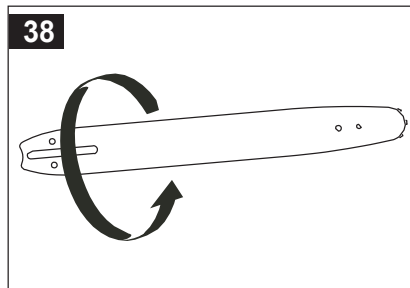

## TRANSPORTING AND STORING

- Do not store or transport the chain saw when it is running. Always remove the battery pack before storing or transporting.
- Always place the guide bar sheath on the guide bar and chain before storing or transporting the chain saw. Use caution to avoid the sharp teeth of the chain.
- Clean the chain saw thoroughly before storing. Store the chain saw indoors, in a dry place that is locked and/or inaccessible to children.
- Keep away from corrosive agents such as garden chemicals and de-icing salts.

# TROUBLESHOOTING

**⚠ WARNING:** Always protect your hands by wearing heavy gloves when performing any maintenance on the saw chain. Always remove the battery pack when servicing or transporting the chain saw.

PROBLEM	CAUSE	SOLUTION
<p>Motor does not run.</p>	<ul style="list-style-type: none"> <li>■ The battery pack is not attached to the chain saw.</li> <li>■ There is no electrical contact between the saw and battery.</li> <li>■ The battery pack is depleted.</li> <li>■ The battery pack or chain saw is too hot.</li> <li>■ The lock-off button is not depressed before pressing the trigger switch.</li> <li>■ Chain brake is engaged.</li> <li>■ Saw chain is bound in the wood.</li> </ul>	<ul style="list-style-type: none"> <li>■ Attach the battery pack to the chain saw.</li> <li>■ Remove the battery, check contacts and reinstall the battery pack.</li> <li>■ Charge the battery pack.</li> <li>■ Allow the battery pack or chain saw to cool until the temperature drops below 152°F (67°C).</li> <li>■ Press down the lock-off button and hold it, then depress the trigger switch to turn on the chain saw.</li> <li>■ Pull the chain kickback brake handle backward toward the front handle.</li> <li>■ Release the trigger switch; remove the saw chain and guide bar from the wood, then restart the chain saw.</li> </ul>

	<ul style="list-style-type: none"> <li>■ Debris in bar groove.</li> <li>■ Debris in side cover.</li> </ul>	<ul style="list-style-type: none"> <li>■ Press the saw chain against the wood, move the chain saw back and forth to discharge the debris.</li> <li>■ Remove battery pack, then remove side cover and clean out debris.</li> </ul>
Motor runs, but chain does not rotate.	<ul style="list-style-type: none"> <li>■ Chain does not engage drive sprocket.</li> </ul>	<ul style="list-style-type: none"> <li>■ Reinstall the chain, making sure that the drive links on the chain are fully seated on the sprocket.</li> </ul>

<p>Chain brake does not engage.</p>	<ul style="list-style-type: none"> <li>■ Debris preventing full movement of the chain kickback brake handle.</li> <li>■ Possible chain brake malfunction.</li> </ul>	<ul style="list-style-type: none"> <li>■ Clean debris from external chain brake mechanism.</li> <li>■ Contact HENX Customer Service.</li> </ul>
<p>Chain saw does not cut properly.</p>	<ul style="list-style-type: none"> <li>■ Insufficient chain tension.</li> <li>■ Dull chain.</li> <li>■ Chain installed backwards.</li> <li>■ Worn chain.</li> <li>■ Dry or excessively stretched chain.</li> <li>■ Chain not in bar groove.</li> </ul>	<ul style="list-style-type: none"> <li>■ Readjust the chain tension, following the section: <b>“ADJUSTING THE CHAIN TENSION”</b>.</li> <li>■ Sharpen the chain cutters, following the section: <b>“HOW TO SHARPEN THE CUTTERS”</b>.</li> <li>■ Reinstall the saw chain, following the section: <b>“REPLACING THE BAR AND CHAIN”</b>.</li> <li>■ Replace the chain, following the section: <b>“REPLACING THE BAR AND CHAIN”</b>.</li> <li>■ Check the oil level. Refill the oil tank if necessary.</li> <li>■ Reinstall the saw chain, following the section: <b>“REPLACING THE BAR AND CHAIN”</b>.</li> </ul>
	<ul style="list-style-type: none"> <li>■ Check chain tension for over tightened condition.</li> </ul>	<ul style="list-style-type: none"> <li>■ Re-tension the saw chain; see the section: <b>“ADJUSTING THE CHAIN TENSION”</b>.</li> </ul>

<p>Bar and chain running hot and smoking.</p>	<ul style="list-style-type: none"><li>■ Chain oil tank is empty.</li><li>■ Debris in guide bar groove.</li></ul>	<ul style="list-style-type: none"><li>■ Filling bar and chain lubricant.</li><li>■ Clear the debris in the groove.</li></ul>
---	--	--



# WARRANTY

## HENX WARRANTY POLICY

4-2 year limited warranty on HENX outdoor power equipment and 2 year limited warranty on HENX battery packs and chargers.

Please contact HENX Customer Service at [866\) 678-8989](tel:866-678-8989) ~~86-571-87248935~~ you have questions or warranty claims.

## LIMITED SERVICE WARRANTY

**FOR FOUR-TWO YEARS** from the date of original retail purchase, this HENX product is warranted against defects in material or workmanship. Defective product will receive free repair.

FOR TWO YEARS from the date of original retail purchase, the HENX battery pack and charger are warranted against defects in material or workmanship.

Defective product will receive free repair.

This warranty does not cover routine maintenance parts and consumables, such as the saw chain and guide bar that can wear out from normal use within the warranty period.

- a) This warranty applies only to the original purchaser from an authorized HENX retailer and may not be transferred.
- b) The warranty period for any HENX product or part used for industrial, professional or commercial purpose is ONE year.
- c) This warranty is void if the product has been used for rental purpose.
- d) This warranty does not cover the damage resulting from modification, alteration or unauthorized repair.
- e) This warranty only covers defects arising under normal usage and does not cover any malfunction, failure or defect resulting from misuse, abuse (including overloading of the product beyond capacity and exposure to water or rain), accidents, neglect or lack of proper installation, and improper maintenance or storage.

- f) This warranty does not cover normal deterioration of the exterior finish, including but not limited to scratches, dents, paint chips, or to any corrosion or discoloring by heat, abrasive and chemical cleaners.

## HOW TO OBTAIN SERVICE

For warranty service, please contact HENX customer service at

[866\) 678-8989](tel:8666788989) ~~86-571-87248935~~. When requesting warranty service, you must present the original dated sales receipt. An authorized service center will be selected to repair the product according to the stated warranty terms.

## ADDITIONAL LIMITATIONS

To the extent permitted by applicable law, all implied warranties, including warranties of MERCHANTABILITY or FITNESS FOR A PARTICULAR PURPOSE, are disclaimed. Any implied warranties, including warranties of merchantability or fitness for a particular purpose, that cannot be disclaimed under state law are limited to five years from the date of purchase for outdoor power equipment and three years from date of purchase for battery pack and charger.

Some states do not allow limitations on how long an implied warranty lasts and/or do not allow the exclusion or limitation of incidental or consequential damages, so the above limitations may not apply to you.

This warranty gives you specific legal rights, and you may also have other rights which vary from state to state.

For customer service contact us at: [866\) 678-8989](tel:8666788989) ~~86-571-87248935~~ or -  
[www.henxgarden.com](http://www.henxgarden.com) HENXPOWER.com HENX customer service.

# PARTS LIST

## 40V LITHIUM-ION CORDLESS CHAIN SAW

Model Number: A40LJ14B01, A40LJ16B01

The Model Number will be found on the Nameplate attached to the housing of the chain saw. Always mention the Model Number when ordering parts for this tool.

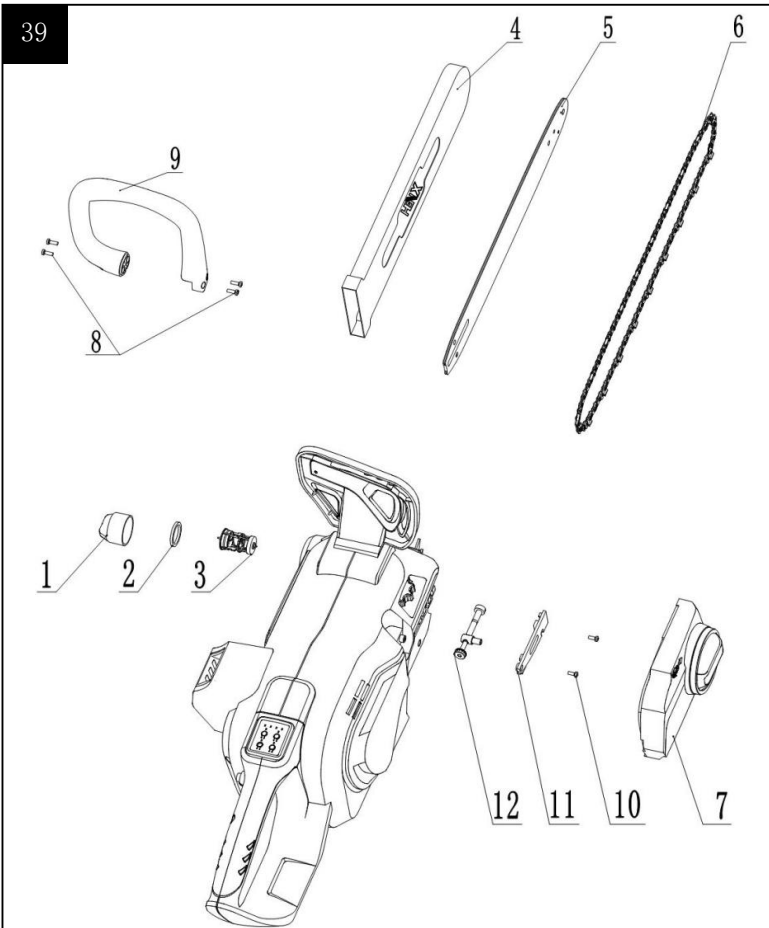

INDEX NUMBER	DESCRIPTION	SPEC	QTY
1	Oil tank cap		1
2	Seal Ring		1
3	Oil filter Assembly		1
4	Chain sheath		1
5	Guide bar	16" (400 mm)	1
6	Saw chain		1
7	Side cover assembly		1
8	Screws	ST4 x 14	4
9	Front handle		1
10	Screws	ST3X10	2
11	Cover plate		1
12	Tensioning screw assembly		1