

# 10' X 13' SOFT-TOP GAZEBO WITH SCREENS & PRIVACY WALLS

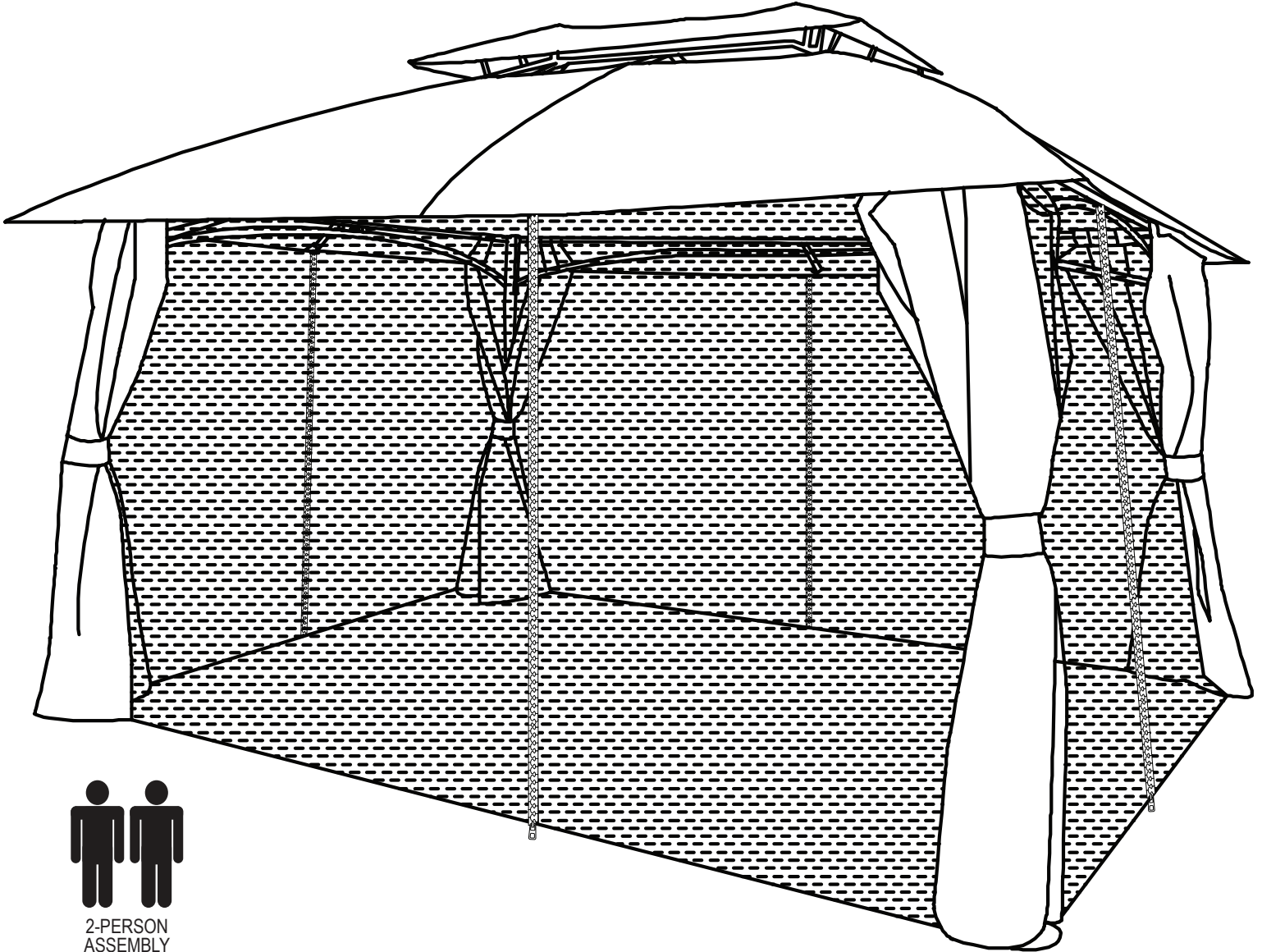

## ! HELPFUL HINT

Sunnydaze advises reading this manual fully, and assembling the gazebo soon after purchase. Check that all parts are accounted for and familiarize yourself with the assembly before beginning.

Save this manual for future reference.



# IMPORTANT SAFETY INFORMATION



## GENERAL SAFETY WARNINGS

Please read, understand and follow all safety statements, warnings, assembly instructions, use & care directions before assembling and using the Gazebo. Failure to follow instructions may result in personal injury or property damage.

The warnings, cautions, and instructions in this manual do not cover all possible conditions or situations that could occur. Use sound judgment and caution when using this canopy. Always be aware of the environment and ensure that the canopy is used in a safe and responsible manner.

- **ADULT ASSEMBLY ONLY!** Before assembling the gazebo, check that the gazebo parts are not damaged. If damage is found, contact Sunnydaze Customer Service. Failure to comply with these guidelines will/can lead to further damage, possible personal injury or property damage.
- Assemble the gazebo on a flat, level surface. Uneven surfaces may cause damage to the frame.
- Ensure that all connectors & poles are positioned correctly and firmly secured before each use.
- **DO NOT** use during inclement weather. This gazebo is for decorative and sunshade purposes only and should *never* be used as shelter or protection for harsh weather conditions.
- **DO NOT** climb on top of the gazebo.
- **DO NOT** leave the gazebo fully assembled when there is a risk of high winds, snow, or heavy rain. Carefully remove the fabric components, fold and secure them in a safe place out of the elements.
- **WARNING:** Keep flame and heat sources away from the gazebo fabric. Exposure to sources of heat may burn the fabric.
- **NEVER** use an open flame under or near the gazebo including, but are not limited to, grills, fire pits, torches, oil lanterns, and candles.
- Keep all components clean; doing so will prolong the appearance and life of the gazebo.
- **DO NOT** use organic solvents to clean the gazebo. Do not use chlorine bleach, do not dry clean. Do not use a pressure washer.
- If the nets and sidewalls get wet, thoroughly air-dry, spread open, in a vertical position. Failure to dry out fabrics will degrade the material and promotes mold and mildew growth; it may also cause the frame to rust.
- When not in use, remove and carefully fold the gazebo fabric, clean the frame and store it in a clean, dry place out of the reach of children.
- **DO NOT** modify this gazebo in any way; altering the structure of the gazebo is unsafe and automatically voids the product warranty.
- Ensure the gazebo is properly anchored at all times. Do not assemble this gazebo where it could encounter high winds. High winds increase the danger of it being carried by the wind which could cause personal injury and property damage.
- Sunburn Warning. This gazebo only provides sun ray protection in the shade area. Depending on the sun's position, this may not be directly under the canopy. Ensure users are aware of the sun's position, wear sunscreen, and actively avoid overexposure to the sun.

# Use & Care

- Check for damaged parts before each use. Carefully check that all parts and hardware are secure.
- Carefully consider the location of the gazebo before assembly to ensure it can be properly anchored. Additional anchoring measures (not included) may be necessary.
- Store the canopy, nets and sidewalls when it is not in use. Prolonged exposure to sunlight inevitably causes fading and degrades fabrics.

## **SEVERE WEATHER**

### **WIND**

Do not use your gazebo in strong winds. If the gazebo is not properly anchored, it is susceptible to uplift. Unsecured gazebos may blow over which may result in personal injury and property damage. Secure the nets and sidewalls to the gazebo legs to prevent them from tearing or increasing the chance of uplift.

### **RAIN**

Do not let rain pool on the top of your canopy. Pooling water will cause the canopy fabric to stretch, and the excessive weight may damage or break the gazebo frame.

### **SNOW**

Do not let snow build up on your canopy. As with pooling rainwater, excessive amounts of snow will stretch the fabric and potentially damage or break the frame.

### **LIGHTNING**

Do not set up, take down, or seek shelter under this gazebo when there is lightning.

## **FABRIC CARE**

### **WASHING**

Use warm, soapy water and a soft cloth or soft-bristle brush to scrub fabrics. Remove soap residue completely before air-drying. A garden hose with a spray nozzle set to a “flat” setting works great for removing soap; spray from top to bottom in vertical swipes until all of the soap residue is removed. Never use bleach or harsh cleansers.

### **DRYING**

Hang the fabric to air dry, avoid hanging the fabric over anything with sharp edges that may rip the fabric. Allow air and light to hit as much of the fabric as possible — this will reduce the chance of mold and mildew.

### **FOLDING**



























Folding the canopy, sidewalls and nets along existing creases and folds will help it retain its natural shape. Never bunch up the cloth components when storing as it will reduce the life of the fabric.

## **FRAME CARE**

### **CLEANING THE GAZEBO FRAME**

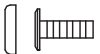
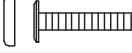
Wipe the frame down with clean, warm water and a damp cloth. Drying the frame is recommended as residual moisture may cause rust.

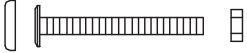
# Components - Parts & Fittings

No.	PARTS	QTY.
A	 Leg	4
B	 Foot	4
C	 Long Beam C	2
D	 Long Beam D	2
E	 Short Beam E	2
F	 Short Beam F	2
G	 Upper Truss	4
H	 Corner Truss	4
I	 Center Truss	1
J	 Peak Hub	2
K	 Side Truss	4
L	 Tent Stake Peg	12
M1	 Main Canopy	1
M2	 Upper Canopy	1
N1	 N1 Screen	2
N2	 N2 Screen	2
N3	 N3 Sidewall	2
N4	 N4 Sidewall	2
O	 Pole Clip	16
P	 M6x30mm Bolt Set	12
Q	 Long Net Pole	4
R	 Short Net Pole	4
S	 M6x15mm Bolt	16
U	 M6x25mm Bolt	8
V	 Hex Key	1
W	 M6x45mm Bolt Set	16
Y	 U-Bracket	8



Inspect packaging to ensure all parts are accounted for before disposing of packing materials.

## ! WARNING !

**CHOKING HAZARD** — This item contains small parts that can be swallowed by children. Keep children away during assembly.

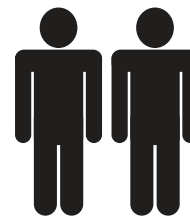

**2-PERSON ASSEMBLY**

## TOOLS REQUIRED (not included)

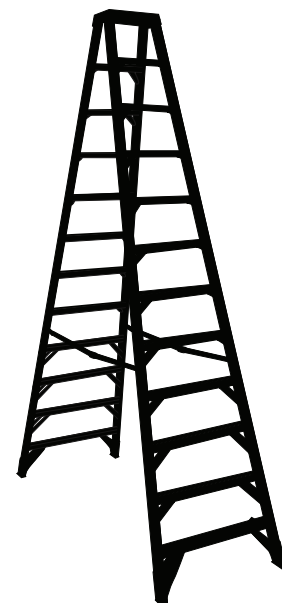

Step Ladder

# STEP 1

- A: 4
- B: 4
- S: 12
- Y: 4

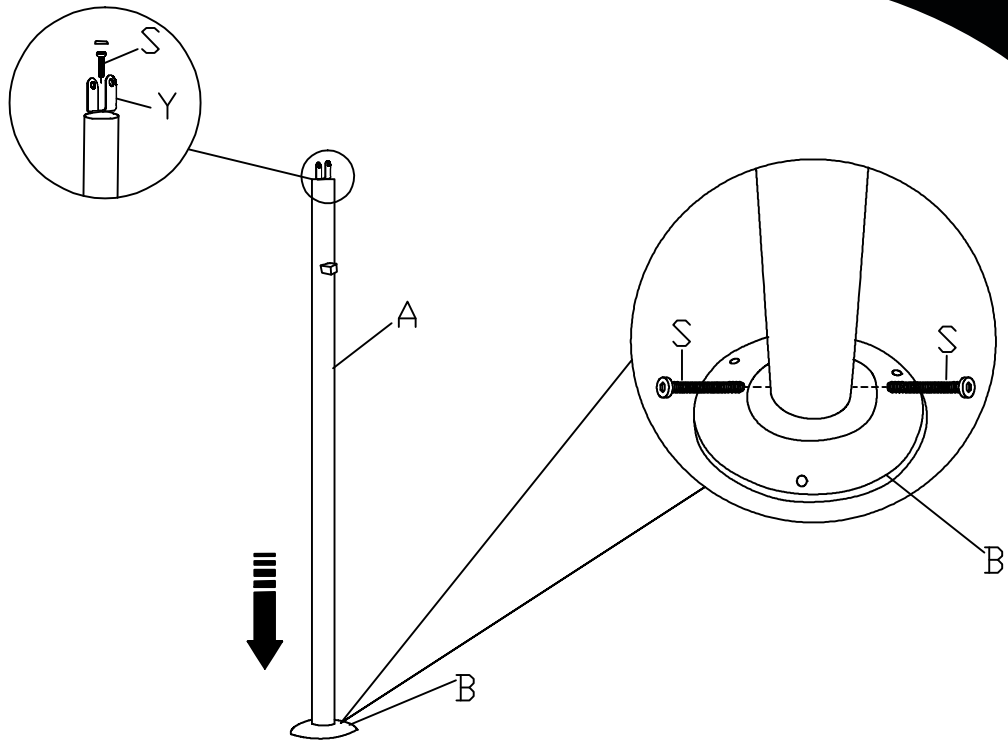

# STEP 2

- C: 2
- D: 2
- O: 8
- P: 2
- S: 2
- W: 8
- Y: 2

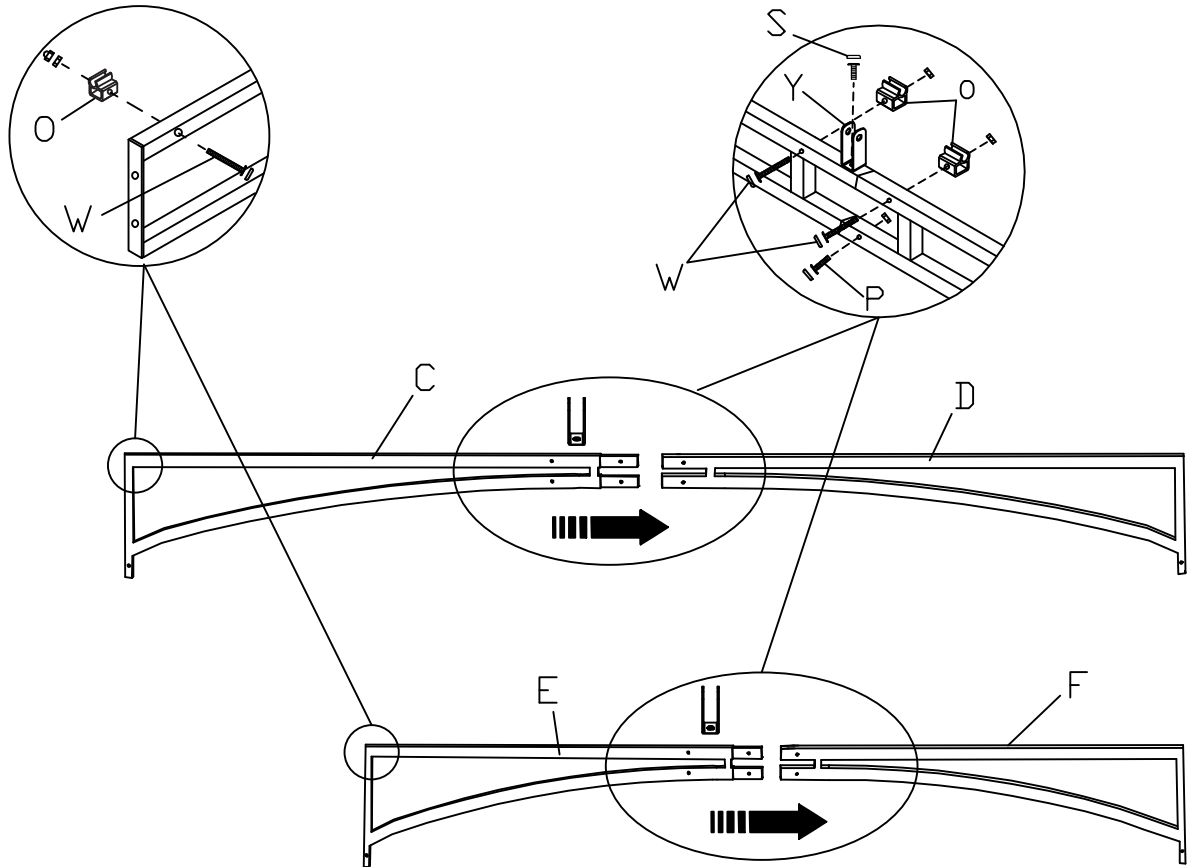

- E: 2
- F: 2
- O: 8
- P: 2
- S: 2
- W: 8
- Y: 2

### STEP 3

Q: 4  
R: 4  
U: 8

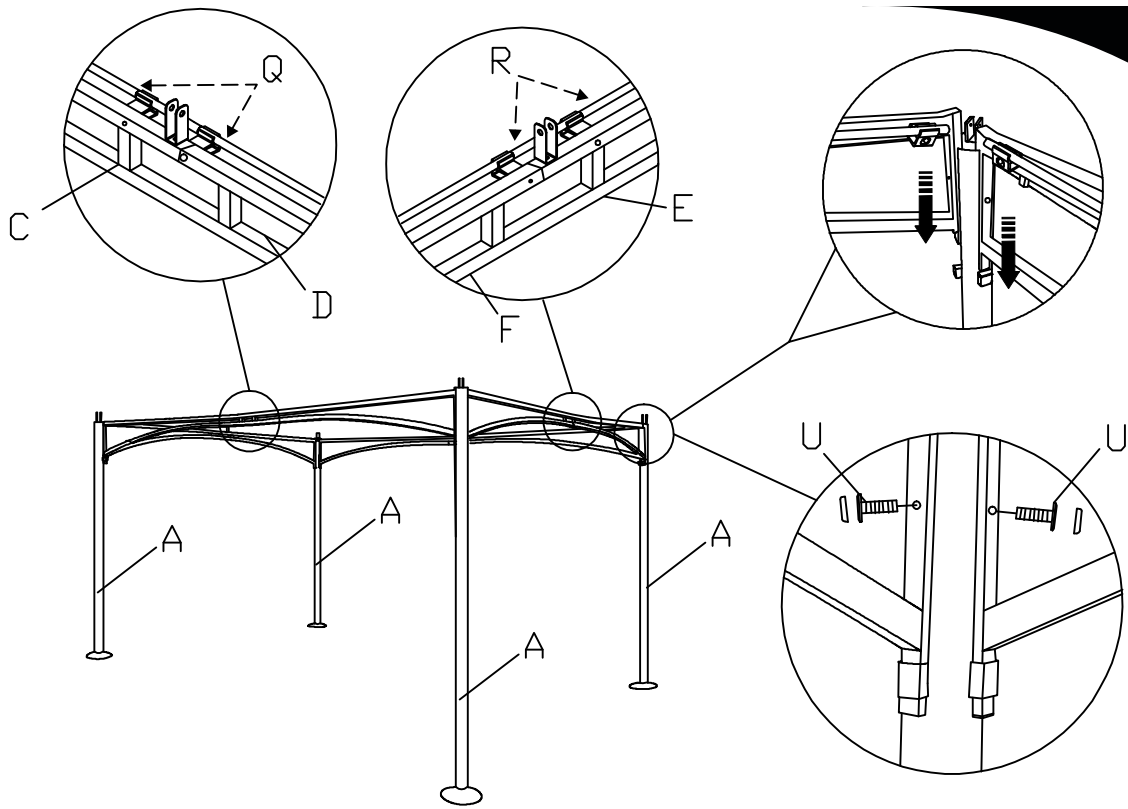

### STEP 4

G: 4  
H: 4  
I: 1  
J: 2  
K: 4

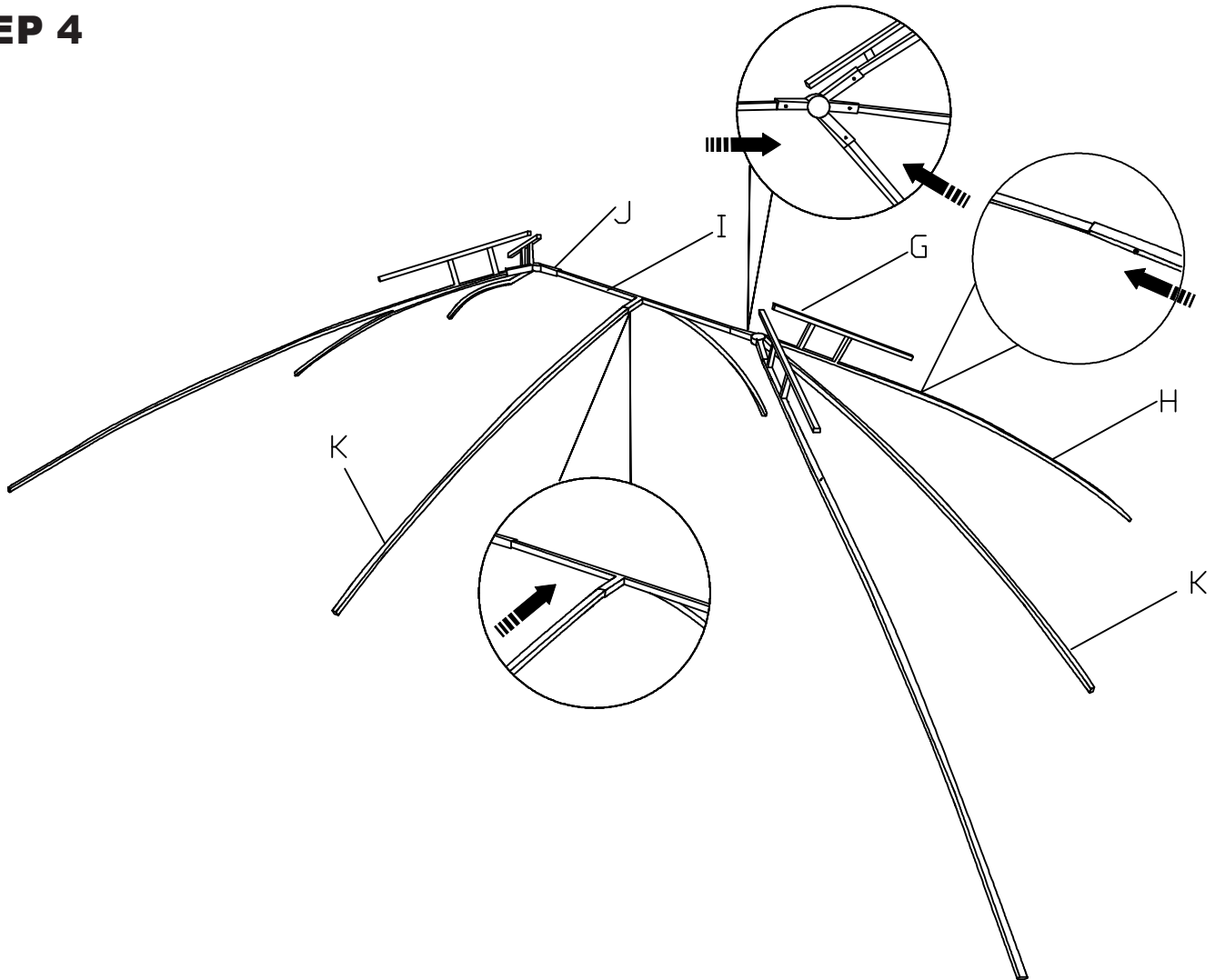

# STEP 5

P: 8

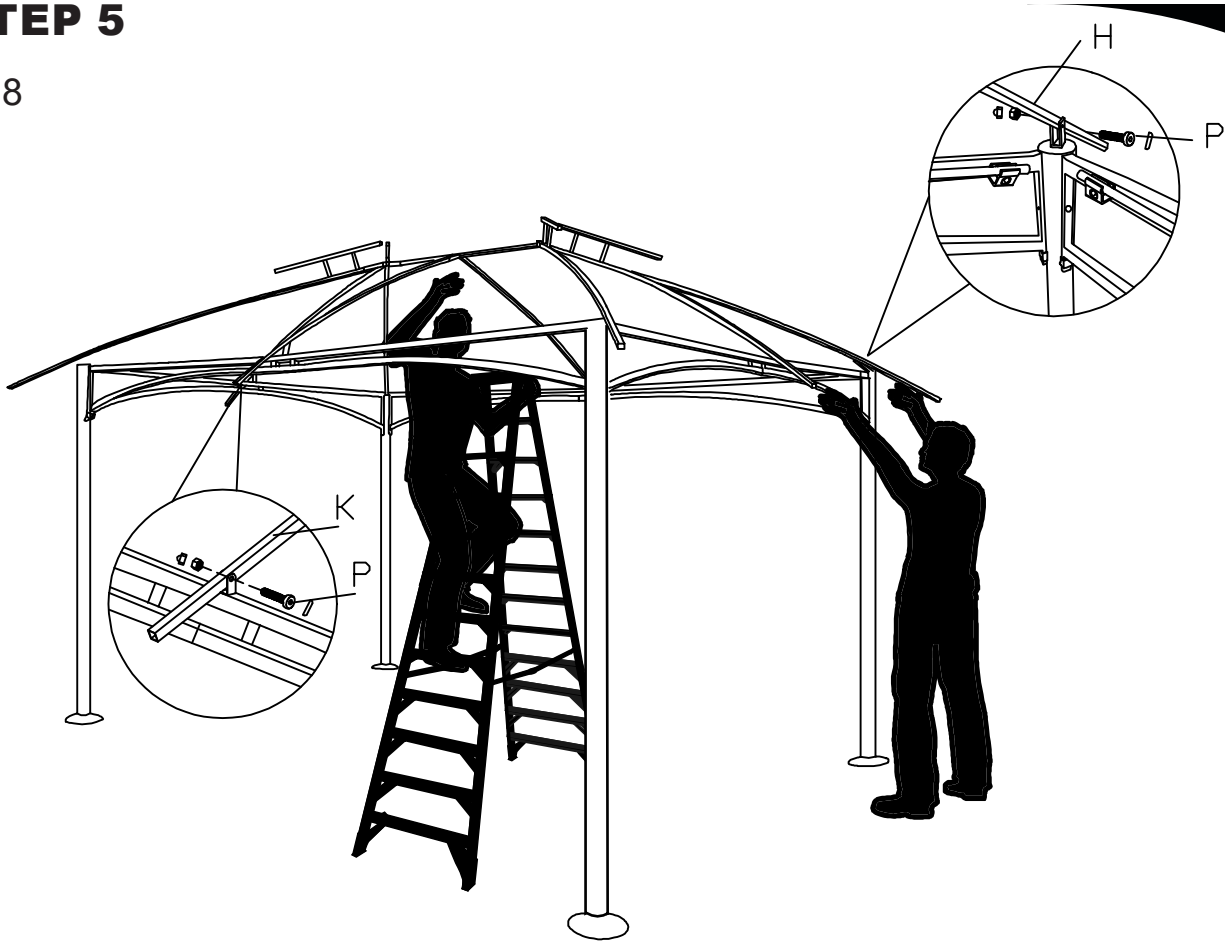

# STEP 6

M2: 1

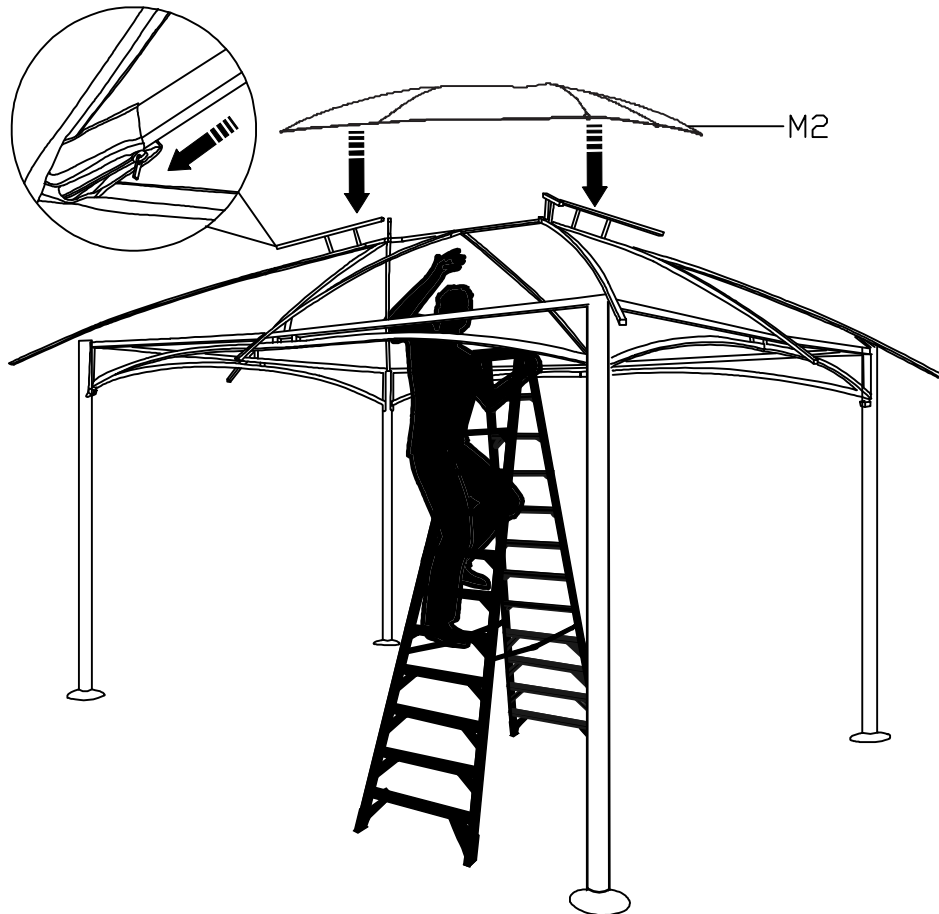

# STEP 7

M1: 1

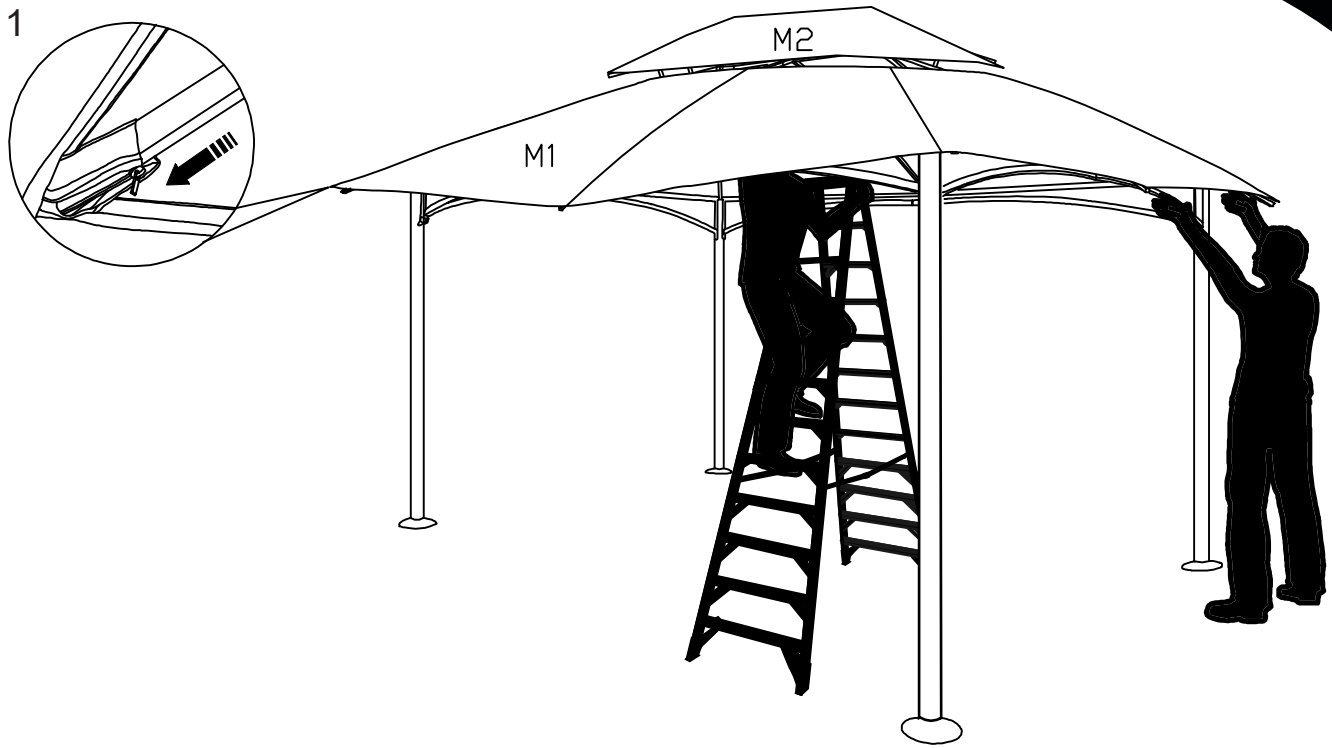

# STEP 8

N3: 2

N4: 2

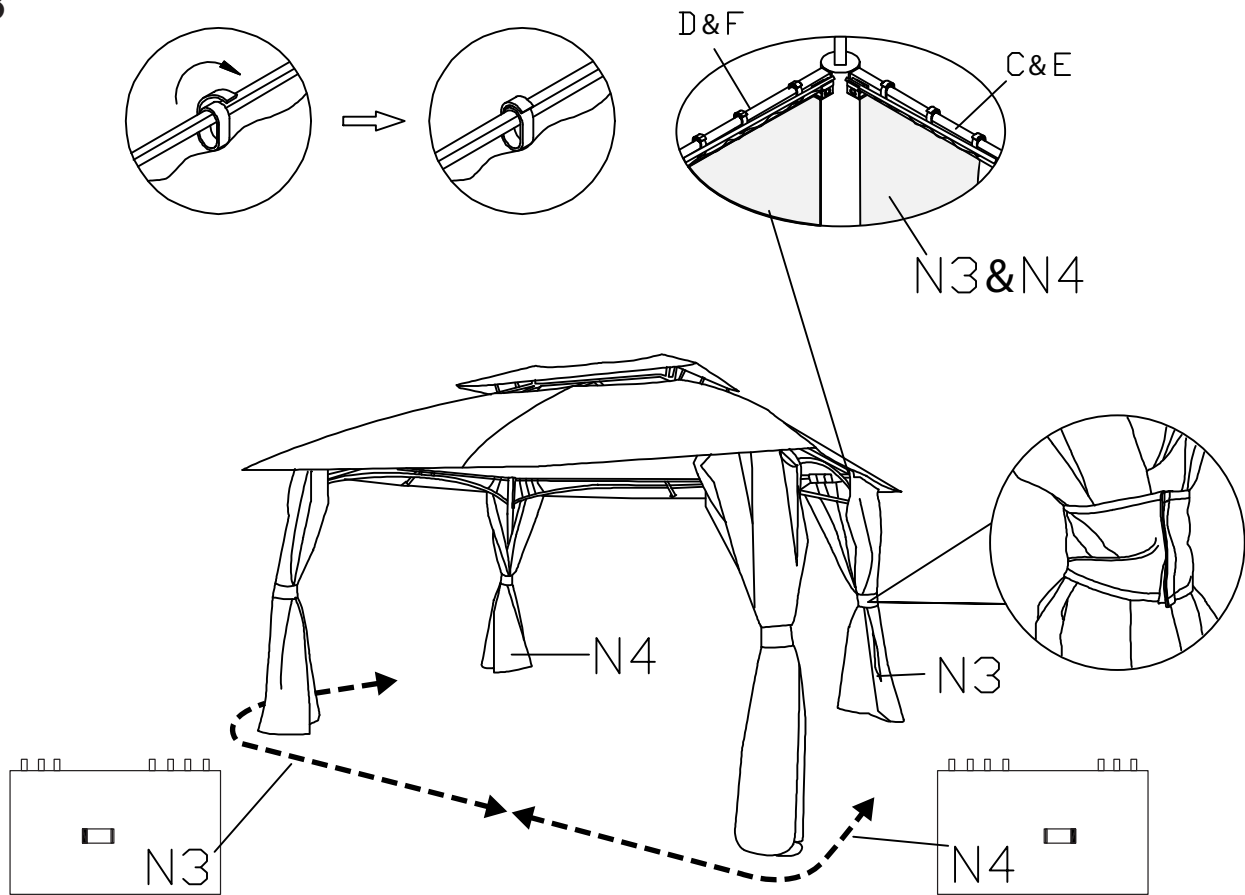



# STEP 9

L: 12  
N1: 2  
N2: 2

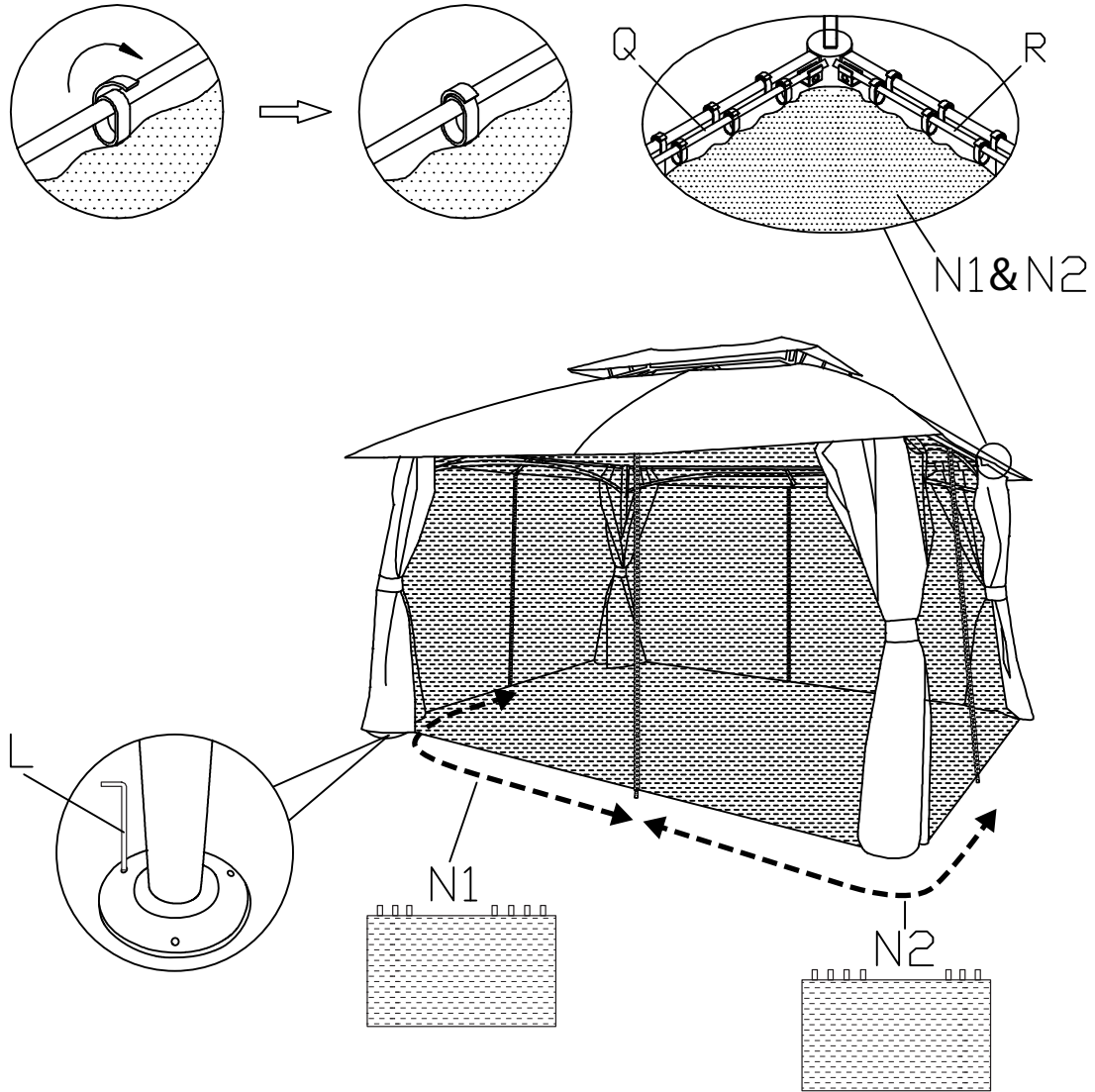

## **⚠️ WARNING!**

Manufacturer and seller expressly disclaim any and all liability from personal injury, property damage or loss, whether direct or indirect, or incidental, resulting from the incorrect attachment, improper use, inadequate maintenance, or neglect of this product.