



Owner's Manual

Original Instructions

Portable air conditioner

Models: GPA05AK
GPA06AK

Thank you for choosing our product.
Please read this Owner's Manual carefully before operation and
retain it for future reference.

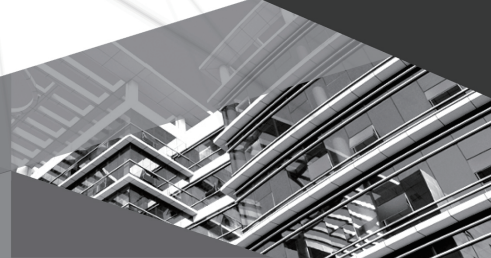

Content

Operation Notices

Operation Environment	1
Safety Warning	2
Part's Name	3

Operation Guide

Operation Introduction for Control Panel	4
Buttons on Remote Controller	6
Introduction for Icons on Display Screen	6
Introduction for Buttons on Remote Controller	7
Function Introduction for Combination Buttons	9
Operation Guide	10
Replacement of Batteries in Remote Controller	10

Maintenance

Clean and Maintenance	11
-----------------------------	----

Malfunction

Malfunction Analysis	13
----------------------------	----

Installation Notice

Installation Precaution	16
Preparation before Installation	17

Installation

Install Wire Hook	18
Removing Collected Water	19
Installation in a double-hung sash window	22
Installation in a sliding sash window	25
Installation and Disassembly of Heat Discharge Pipe	30

Attached Sheet

Operation Test	32
Electric Schematic Diagram	33

This appliance is not intended for use by persons (including children) with reduced physical, sensory or mental capabilities or lack of experience and knowledge, unless they have been given supervision or instruction concerning use of the appliance by a person responsible for their safety. Children should be supervised to ensure that they do not play with the appliance.

Explanation of Symbols



DANGER

Indicates a hazardous situation that, if not avoided, will result in death or serious injury.



WARNING

Indicates a hazardous situation that, if not avoided, could result in death or serious injury.



CAUTION

Indicates a hazardous situation that, if not avoided, may result in minor or moderate injury.

NOTICE

Indicates important but not hazard-related information, used to indicate risk of property damage.



Indicates a hazard that would be assigned a signal word **WARNING** or **CAUTION**.

Exception Clauses

Manufacturer will bear no responsibilities when personal injury or property loss is caused by the following reasons.

1. Damage the product due to improper use or misuse of the product;
2. Alter, change, maintain or use the product with other equipment without abiding by the instruction manual of manufacturer;
3. After verification, the defect of product is directly caused by corrosive gas;
4. After verification, the defects are due to improper operation during transportation of product;
5. Operate, repair, maintain the unit without abiding by instruction manual or related regulations;
6. After verification, the problem or dispute is caused by the quality specification or performance of parts and components that produced by other manufacturers;
7. The damage is caused by natural calamities, bad using environment or force majeure.

If it needs to install, move or maintain the air conditioner, please contact dealer or local service center to conduct it at first. Air conditioner must be installed, moved or maintained by appointed unit. Otherwise, it may cause serious damage or personal injury or death.

When refrigerant leaks or requires discharge during installation, maintenance, or disassembly, it should be handled by certified professionals or otherwise in compliance with local laws and regulations.

Operation Environment

- The air conditioner must be operated within the temperature range: 61°F~95°F(16°C ~ 35°C).
- The appliance is for indoor use only.
- The appliance must be positioned so that the plug is accessible.
- This air conditioner can only be used for family, not for commercial industry.
- Reserved space around the air conditioner should be 12"(30cm) at least.
- Do not operate the air conditioner at humid environment.
- Please keep air inlet and air outlet clean, no obstacles.
- During operation, close doors and windows to improve cooling effect.
- Please put the air conditioner at smooth and flat ground for operation to avoid noise and vibration.
- This air conditioner is equipped with castors. Castors should slide at smooth and flat ground.
- Prohibit inclining or turning over the air conditioner. If there's abnormality, please disconnect power immediately and contact dealer.
- Avoid direct sunshine.

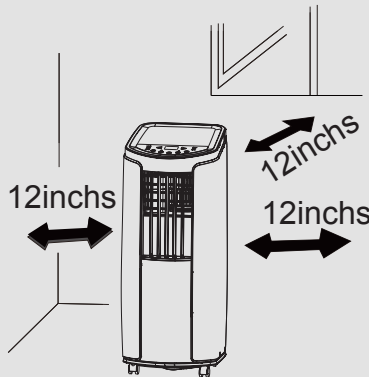

Safety Warning

- This appliance can be used by children aged from 8 years and above and persons with reduced physical, sensory or mental capabilities or lack of experience and knowledge if they have been given supervision or instruction concerning use of the appliance in a safe way and understand the hazards involved. Children shall not play with the appliance. Cleaning and user maintenance shall not be made by children without supervision.
- Before operation, please confirm whether power specification complies with that on nameplate.
- Before cleaning or maintaining the air conditioner, please turn off air conditioner and pull out the power plug.
- Make sure the power cord hasn't been pressed by hard objects.
- Do not pull or drag the power cord to pull out the power plug or move the air conditioner.
- Do not insert or pull out the power plug with wet hands.
- Please use the grounded power. Make sure the grounding is reliable.
- If the supply cord is damaged, it must be replaced by the manufacturer or its service agent or a similarly qualified person in order to avoid a hazard.
- If abnormal condition occurs (e.g. burned smell), please disconnect power at once and then contact local dealer.
- When nobody is taking care of the unit, please turn it off and remove the power plug or disconnect power.
- Do not splash or pour water on air conditioner. Otherwise, it may cause short circuit or damage to air conditioner.
- If drainage hose is used, ambient temperature can't be lower than 0°C. Otherwise, it will cause water leakage to air conditioner.
- Prohibit operating heating equipment around the air conditioner.
- Far away from fire source, inflammable and explosive objects.
- Children and disabled people are not allowed to use the portable room air conditioner without supervision.
- Keep children from playing or climbing on the air conditioner.
- Do not put or hang dripping objects above the air conditioner.
- Do not repair or disassemble the air conditioner by yourself.
- Prohibit inserting any objects into the air conditioner.
- Do not use an extension cord.
- Prohibit operating the unit in the bathroom or laundry room.

Part's Name

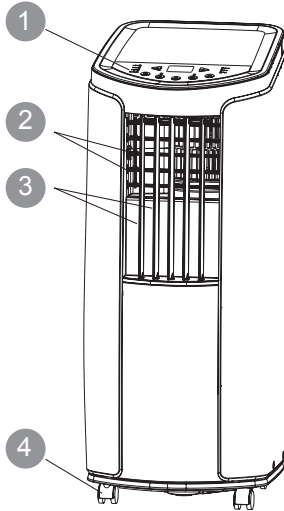

- 1 Controller panel
- 2 Guide louver
- 3 Swing louver
- 4 Castor
- 5 Wire-fixing hook
- 6 Plug of power cord
- 7 Filter
- 8 Air inlet
- 9 Joint A
- 10 Heat discharge pipe
- 11 Joint B+C

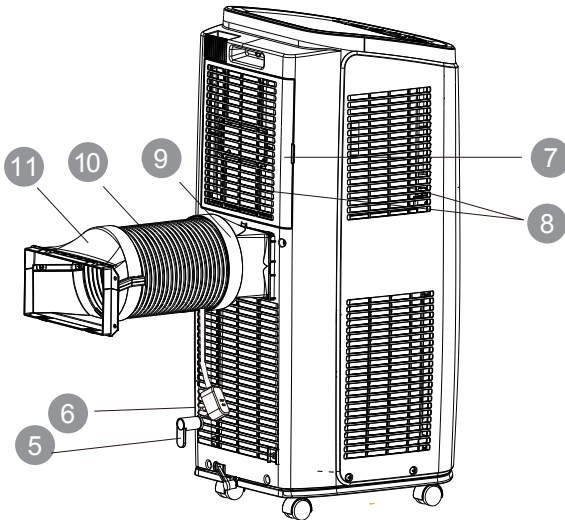

Remote controller

This picture is only for reference. Please refer to the actual product for the appearance.

NOTICE:

Heat discharge pipe and other installation accessories can't be discarded.

Operation Introduction for Control Panel

Name of control panel

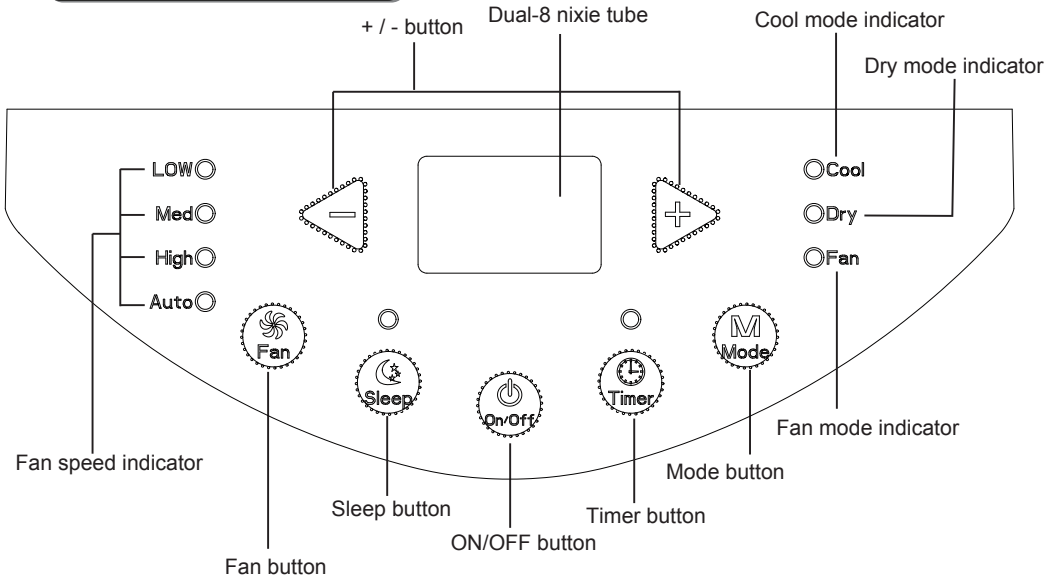

Operation of control panel

Note:

- After putting through the power, the air conditioner will give out a sound. After that, you can operate the air conditioner by the control panel.
- Under ON status, after each pressing of the button on control panel, the air conditioner will give out a sound. Meanwhile, corresponding indicator on control panel will be bright.
- Under OFF status, dual-8 nixie tube on control panel won't display. Under ON status, dual-8 nixie tube on control panel will display set temperature under cooling mode, while it won't display under other modes.

1 ON/OFF button

Pressing this button can turn on or turn off the air conditioner.

2 +/- button

Under cooling mode, press "+" or "-" button to increase or decrease set temperature by 1°F(°C). Set temperature range is 61°F(16°C)~86°F(30°C). Under auto, drying or fan mode, this button is invalid.

Operation Introduction for Control Panel

3 Mode button

Press this button and the mode will circulate according to below sequence:

COOL→DRY→FAN

COOL: Under this mode, cooling mode indicator is bright. Dual-8 nixie tube displays set temperature. Temperature setting range is 61°F(16°C)~86°F(30°C).

DRY: Under this mode, drying mode indicator is bright. Dual-8 nixie tube won't display.

FAN: Under this mode, the air conditioner only blow fan. Fan indicator is bright. Dual-8 nixie tube won't display.

4 Fan button

Press this button and the fan speed will circulate as "low speed→ medium speed → high speed→ auto fan→ low speed".

5 Timer button

Press timer button to enter into timer setting mode. Under this mode, press " + " or " - " button to adjust the timer setting. Timer setting will increase or decrease 0.5 hour by pressing " + " or " - " button within 10 hours, while timer setting will increase or decrease 1 hour by pressing " + " or " - " button beyond 10 hours. After timer setting is finished, the unit will display temperature if there's no operation for 5s. If timer function is started up, the upper indicator will keep the display status. Others, it won't be displayed. Under timer mode, press timer button again to cancel timer mode.

6 Sleep button

Press sleep button to enter into sleep mode. If the controller operates at cooling mode, after sleep mode is started up, preset temperature will increase by 2°F(1°C) within 1 hour ;preset temperature will increase by 4°F(2°C) within 2 hours and then the unit will operate at this temperature all the time; Sleep function is not available for fan mode, drying mode and auto mode. If sleep function is started up, the upper indicator will keep the display status. Others, it won't be displayed.

Buttons on remote controller

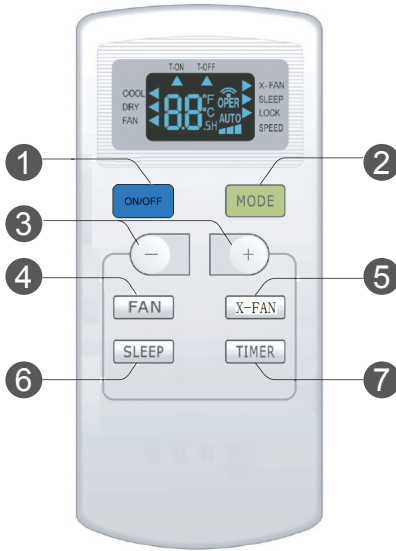

- ① ON/OFF button
- ② MODE button
- ③ +/- button
- ④ FAN button
- ⑤ X-FAN button
- ⑥ SLEEP button
- ⑦ TIMER button

Introduction for icons on display screen

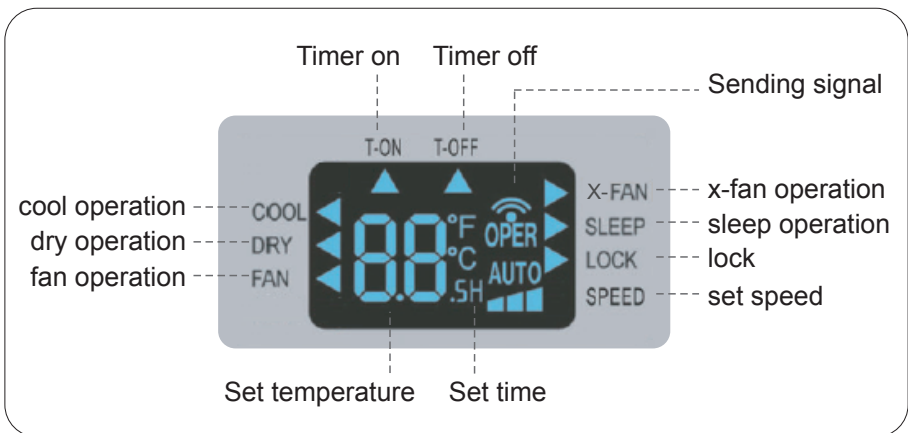

Introduction for buttons on remote controller

Note:

- When power is connected(stand by condition), you can operate the air conditioner through the remote controller.
- When unit is on, each time you press the button on remote controller, the sending signal icon "📶" on the display of remote controller will blink once. If the air conditioner gives out a beep sound, it means the signal has been sent.
- When unit is off, set temperature will be displayed on the remote controller (If the light of indoor unit display is turned on, the corresponding icon will be displayed); When unit is on, it will display the icon of the on-going function.

1 ON/OFF button

Press this button to turn unit on/off.

2 MODE button

Pressing this button once can select your required mode circularly as below (the corresponding icon "◀" will be lit up after the mode is selected):



- When selecting cool mode, air conditioner will operate under cool mode. Then press + or - button to adjust set temperature. Press FAN button to adjust fan speed.
- When selecting dry mode, air conditioner will operate at low fan speed under dry mode. In dry mode, fan speed can't be adjusted.
- When selecting fan mode, air conditioner will operate in fan mode only. Then press FAN button to adjust fan speed.

3 + / - button

- Pressing + or - button once will increase or decrease set temperature by 1°F(°C). Hold + or - button for 2s, set temperature on remote controller will change quickly. Release the button after your required set temperature is reached.
- When setting Timer On or Timer Off, press + or - button to adjust the time. (See TIMER Button for setting details)

4 FAN button

Pressing this button can select fan speed circularly as: AUTO, SPEED 1 (▲), SPEED 2 (▲▲), SPEED 3 (▲▲▲).

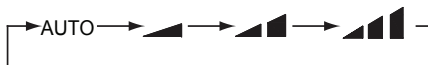

Introduction for buttons on remote controller

Note:

- Under Auto speed, air conditioner will select proper fan speed automatically according to ambient temperature.
- Fan speed can't be adjusted under Dry mode.

5 X-FAN button

Press this button under cool and dry mode to start up x-fan function, Press this button again to cancel x-fan function.

Note:

- When x-fan function is on, if the air conditioner is turned off, indoor fan will still operate at low speed for a while to blow the residual water inside the air duct.
- During x-fan operation, press X-FAN button to turn off x-fan function. Indoor fan will stop operation immediately.

6 SLEEP button

Under Cool and Dry mode, press this button to turn on Sleep function. Press this button to cancel Sleep function. Under Fan mode, this function is unavailable.

7 TIMER button

- When unit is on, press this button to set Timer Off. T-OFF and H icon will be blinking. Within 5s, press + or - button to adjust the time for Timer Off. Pressing + or - button once will increase or decrease the time by 0.5h. Hold + or - button for 2s, time will change quickly. Release the button after your required set time is reached. Then press TIMER button to confirm it. T-OFF and H icon will stop blinking.
- When unit is off, press this button to set Timer On. T-ON and H icon will be blinking. Within 5s, press + or - button to adjust the time for Timer On. Pressing + or - button once will increase or decrease the time by 0.5h. Hold + or - button for 2s, time will change quickly. Release the button after your required set time is reached. Then press TIMER button to confirm it. T-ON and H icon will stop blinking.
- Cancel Timer On/Off: If Timer function is set up, press TIMER button once to review the remaining time. Within 5s, press TIMER button again to cancel this function.

Introduction for buttons on remote controller

Note:

- Range of time setting is: 0.5~24h
- The interval between two motions can't exceed 5s, otherwise the remote controller will exit setting status.

Function introduction for combination buttons

Child lock function

Press “+” and “-” buttons simultaneously can turn on or turn off child lock function. When child lock function is started up, LOCK indicator on remote controller is ON. If you operate the remote controller, remote controller won't send signal.

Temperature display switchover function

Under OFF status, press “-” button and “MODE” button simultaneously can switch between °C and °F.

Light function

Under switch-on or switch-off state, you may hold "+" and "FAN" buttons simultaneously for 3 seconds to set the lamp on or off and send the code. After being energized the lamp is defaulted on.

Operation guide

1. After putting through the power, press "ON/OFF" button on remote controller to turn on the air conditioner.
2. Press "MODE" button to select your required mode: COOL, DRY, FAN.
3. Press "+" or "-" button to set your required temperature. (Temperature can't be adjusted under auto mode).
4. Press "FAN" button to set your required fan speed: auto, low, medium and high speed.

Replacement of batteries in remote controller

1. Press the back side of remote controller on the spot marked with "", and then push out the cover of battery box along the arrow direction.
2. Replace two No.7 (AAA 1.5V) dry batteries and make sure the positions of + and- polar are correct.
3. Reinstall the cover of battery box.

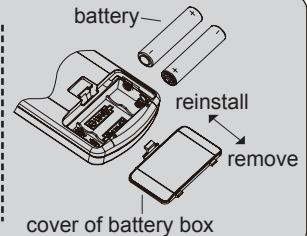

NOTICE

- During operation, point the remote control signal sender at the receiving window on indoor unit.
- The distance between signal sender and receiving window should be no more than 8m, and there should be no obstacles between them.
- Signal may be interfered easily in the room where there is fluorescent lamp or wireless telephone; remote controller should be close to indoor unit during operation.
- Replace new batteries of the same model when replacement is required.
- When you don't use remote controller for a long time, please take out the batteries.
- If the display on remote controller is fuzzy or there's no display, please replace batteries.

Clean and Maintenance

⚠ WARNING

- Before cleaning the air conditioner, please turn off the unit and disconnect power. Otherwise, it may cause electric shock.
- Do not wash air conditioner with water. Otherwise, it may cause electric shock.
- Do not use volatile liquid (such as thinner or gas) to clean the air conditioner. Otherwise, it may damage the appearance of air conditioner.
- Do not use liquid or corrosive detergent clean the appliance and do not splash water or other liquid onto it, otherwise, it may damage the plastic components, even cause electric shock.

Clean outer case and grille

Clean outer case:

If there's dust on the surface of outer case, please use soft towel to wipe it. If the outer case is very dirty (such as grease), please use neutral abluent to wipe it.

Clean grille: Use cleaner or soft brush to clean it.



Clean filter

1 Remove the filter

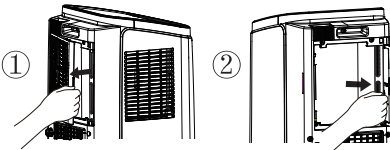

Install filter

3 After the filter is cleaned and dried, reinstall it well.

Clean filter

2 Use cleaner or water to clean the filter. If the filter is very dirty (such as grease), use warm water 104°F (40°C) melted with neutral abluent to clean it and then put at shady place to dry it.

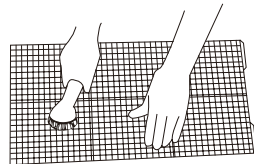

NOTICE

- The filter should be cleaned about once every three months. If there's much dust in the operation environment, you can increase clean frequency.
- Do not dry the filter with fire or hair drier. Otherwise, it may be deformed or catch fire.

Clean and Maintenance

Clean heat discharge pipe

Remove the heat discharge pipe from air conditioner, clean and dry it , and then reinstall it. (For the method of installation and removal , please refer to the instruction for "Installation and disassembly of heat discharge pipe").

Checking before use-season

1. Check whether air inlets and air outlets are blocked.
2. Check whether plug and socket are in good condition.
3. Check whether filter is clean.
4. Check whether batteries are installed in remote controller.
5. Check whether joint, window bracket and heat discharge pipe are installed tightly.
6. Check whether heat discharge pipe is damaged.

Checking after use-season

1. Disconnect power supply.
2. Clean filter and outer case.
3. Remove dust and sundries on the air conditioner.
4. Eliminate accumulated water in chassis (refer to the section of "Drainage way" for details).
5. Check whether window bracket is damaged or not. If yes, please contact dealer.

Long-time storage

If you don't use the air conditioner for a long time, please maintain it by following steps for good performance:

- Make sure there's no accumulated water in chassis and the heat discharge pipe is disassembled.
- Pull out the plug and wrap the power cord.
- Clean the air conditioner and pack it well to prevent dust.

Notice for recovery

- Many packing materials are recyclable materials. Please deal with them through local recycle bin.
- If you want to throw away the air conditioner, please contact local division or consultant service center for the correct disposal method.

Malfunction Analysis

Please check below items before asking for maintenance. If the malfunction still can't be eliminated, please contact local dealer or qualified professionals.

Phenomenon	Troubleshooting	Solution
Air conditioner can't operate	● Power failure?	● Wait after power recovery.
	● Is plug loose?	● Reinsert the plug.
	● Whether the air switch is tripped off or fuse is burnt?	● Ask professional person to replace air switch or fuse.
	● Is there's malfunction for the circuit?	● Ask professional person to replace circuit.
	● Whether the unit is restarted up after stopping immediately?	● Wait for 3min, and then turn on the unit again.
Poor cooling (heating)	● Is the power too low?	● Wait after voltage is resumed.
	● Whether the air filter is too dirty?	● Clean the air filter.
	● Whether the set temperature is proper?	● Adjust the temperature.
	● Whether door and window are closed?	● Close door and window.
Air conditioner can't receive signal from remote controller or remote controller is not sensible.	● Whether the unit is interfered seriously (such as static pressure, unstable voltage)?	● Please pull out the plug. Insert the plug after about 3min, and then turn on the unit.
	● Whether remote controller is within the receiving range?	● The receiving range of remote controller is 8m. Do not exceed this range.
	● Whether it's blocked by obstacles?	● Remove the obstacles.
	● Is sensitivity of remote controller low?	● Check the batteries of remote controller. If the power is low, please replace the batteries.
	● Whether there's fluorescence lamp in the room?	● Move the remote controller close to air conditioner. ● Turn off the fluorescence lamp and try it again.

Malfunction analysis

Phenomenon	Troubleshooting	Solution
No fan blowed out from air conditioner	<ul style="list-style-type: none"> • Whether air outlet or air inlet is blocked? 	<ul style="list-style-type: none"> • Eliminate the obstacles.
	<ul style="list-style-type: none"> • Under heating mode, whether indoor temperature reaches set temperature? 	<ul style="list-style-type: none"> • mobile unit will stop blowing fan after reaching set temperature.
	<ul style="list-style-type: none"> • Whether heating mode is started up just now? 	<ul style="list-style-type: none"> • In order to prevent cold air, air conditioner will delay for a while to be started up, which is the normal phenomenon.
	<ul style="list-style-type: none"> • Whether evaporator is defrosted? (observe it by pulling out the filter) 	<ul style="list-style-type: none"> • It's the normal phenomenon. Air conditioner is defrosting. After defrosting is finished, it will resume operation.
Set temperature can't be adjusted.	<ul style="list-style-type: none"> • Whether the unit operates under auto mode? 	<ul style="list-style-type: none"> • Temperature can't be adjusted under auto mode.
	<ul style="list-style-type: none"> • Whether the required temperature exceeds the temperature setting range? 	<ul style="list-style-type: none"> • Temperature setting range: 61°F(16°C)~86°F(30°C).
There's off flavour	<ul style="list-style-type: none"> • There's off-flavour source in the room, such as furniture, cigarette etc. 	<ul style="list-style-type: none"> • Eliminate the off-flavour source. • Clean the filter.
There's abnormal sound during operation	<ul style="list-style-type: none"> • Whether the unit is interfered by thunder, radio, etc? 	<ul style="list-style-type: none"> • Disconnect power, put through the power again, and then turn on the unit again.
You can heard water-flowing sound	<ul style="list-style-type: none"> • Whether the unit is turned on or turned off just now? 	<ul style="list-style-type: none"> • There's flowing sound of refrigerant inside the air conditioner, which is the normal phenomenon.
You can heard the sound of "PAPA"	<ul style="list-style-type: none"> • Whether the unit is turned on or turned off just now? 	<ul style="list-style-type: none"> • Heat expansion or shrinkage for the panel due to change of temperature, which cause friction sound.

Malfunction analysis

Malfunction code

H8	Chassis is full of water.	1. Pour out the water inside chassis. 2. If "H8" still exists, please contact professional person to maintain the unit.
F1	Malfunction of ambient temperature sensor.	Please contact professional person to deal with it.
F2	Malfunction of evaporator temperature sensor.	Please contact professional person to deal with it.
F0	1.Refrigerant is leaking 2.System is blocked	1. Re-energize the unit after turning off and pulling out the plug for 30min; 2. If there's still malfunction, please contact after-sales service.
H3	Overload protection for compressor	1.Check if the unit is under high-temperature and high-humidity environment; if ambient temperature is too high, power off the unit and then energize it for operation after the ambient temperature drops to 35℃below. 2. Check if the evaporator and condenser are blocked by some objects; if yes, take away the objects, power off the unit and then energize it for operation.
E8	Overload malfunction	3. If the malfunction still occur, please contact our after-sales service center.
F4	Outdoor tube temperature sensor is open/short-circuited.	Please contact after-sale service person to deal with it.



WARNING

- If there're following phenomenon, please turn off the air conditioner and disconnect the power immediately, and then contact dealer immediately.
 - Power cord is overheating or damaged.
 - Abnormal sound during operation.
 - Off-flavor.
 - Water leakage
- Do not repair or refit the air conditioner by yourself.
- If operate the air conditioner under abnormal condition, it may cause malfunction, electric shock or fire hazard.

Installation Precaution



WARNING

- Observe all governing codes and ordinances.
- Do not use damaged or non-standard power cord.
- Be caution during installation and maintenance. Prohibit incorrect operation to prevent electric shock, casualty and other accidents.

Selection of installation location

Basic requirement

Installing the unit in the following places may cause malfunction. If it is unavoidable, please consult the local dealer:

1. The place with strong heat sources, vapors, flammable or explosive gas, or volatile objects spread in the air.
2. The place with high-frequency devices (such as welding machine, medical equipment).
3. The place near coast area.
4. The place with oil or fumes in the air.
5. The place with sulfureted gas.
6. Other places with special circumstances.

Requirement of air conditioner

1. Air inlet should be far away from obstacles and do not put any objects near air outlet. Otherwise, it will affect the radiation of heat discharge pipe.
2. Select a location where the noise and outflow air emitted by the outdoor unit will not affect neighborhood.
3. Please try your best to keep far away from fluorescent lamp.
4. The appliance shall not be installed in the laundry.

Requirements for electric connection



WARNING:















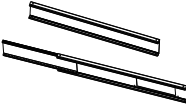



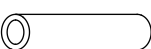



Safety precaution

1. Must follow the electric safety regulations when installing the unit.
2. According to the local safety regulations, use qualified power supply circuit.
3. For appliances with type Y attachment, the instructions shall contain the substance of the following. If the supply cord is damaged, it must be replaced by the manufacturer, its service agent or similarly qualified persons in order to avoid a hazard.
4. Properly connect the live wire, neutral wire and grounding wire of power socket.
5. Be sure to cut off the power supply before proceeding any work related to electricity and safety.
6. Do not put through the power before finishing installation.
7. The air conditioner is first class electric appliance. It must be properly grounding with specialized grounding device by a professional. Please make sure it is always grounded effectively, otherwise it may cause electric shock.
8. The yellow-green wire or green wire in air conditioner is grounding wire, which can't be used for other purposes.
9. The grounding resistance should comply with national electric safety regulations.
10. The appliance shall be installed in accordance with national wiring regulations.





Preparation before installation

Note: check if the accessories are available before installation.

Accessory list

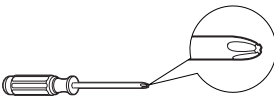
 joint A	 joint B	 joint C	 heat discharge pipe	 Adapter	
 window panel	 wire hook	 screw	 window fastener	 protective grille	
 drainage pipe	 pipe hoop	 rain shield	 pipe clip	 rubber plug	 nut
		 support	 bolt	 spring washer	 washer
 sponge A	 sponge B	 remote controller	 battery (AAA 1.5V)	 user's manual	

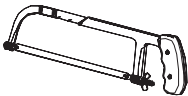
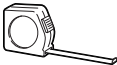
Tools needed for installation

 cross screwdriver	 straight screwdriver	 saw
 gauge	 scissors	 pencil

Install Wire Hook

- Assemble the wire hook at the back of the unit with screws (the direction of wire hook is as shown in following fig).

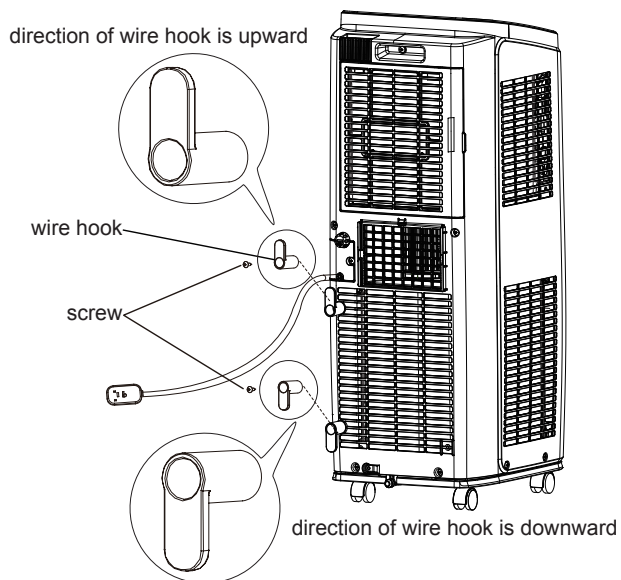

- Wind the power cord around the wire hook.

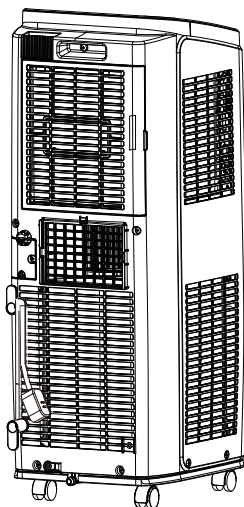

Removing Collected Water

There are 2 ways to remove collected water:

1 Use the continuous drainage option from the bottom hole.

Note: When using the continuous drainage option from the bottom hole, install drainage pipe before using, otherwise poor drainage will affect normal operation of the unit.

■ Instructions for drainage pipe installation as follows.

1. Remove the rubber plug at drainage port.

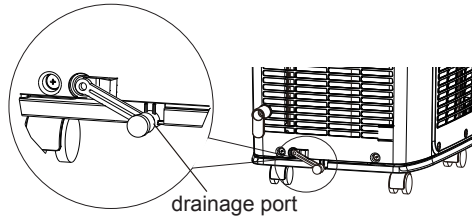

2. Fix the drainage pipe clip on the right of rear side plate near drainage port with a screw.

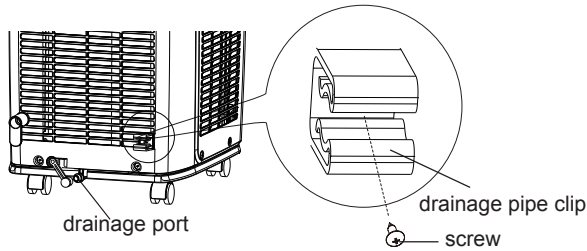

3. Put the drainage pipe into drainage port and screw it up, and then bind it with pipe hoop.

4. Put the rubber plug into the other side of drainage pipe, fix it with pipe hoop and then fix it in the drainage pipe clip.

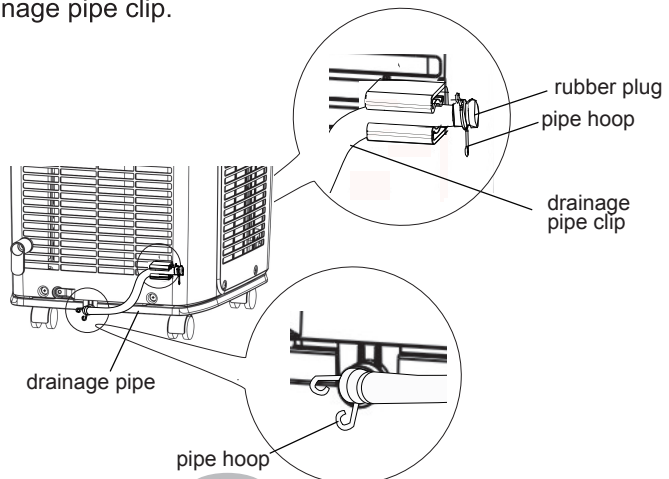

Removing Collected Water

■ Drainage way as follows.

1. In cooling or drying operation, the condensation water will be drained to the chassis and spattered by water-striking motor. As the temperature of condenser is high, most of the condensation water will be evaporated and drained to outdoor. So usually, only a little condensation water will be accumulated inside the chassis and you do not need to discharge the water frequently.
2. When the chassis is full with water, the buzzer will give out 8 sounds and "H8" is displayed to remind user to discharge water:
 - Move the unit to a suitable place for discharging water; do not tilt the unit and keep it horizontal during moving;
 - Take the drainage pipe from the clip and pull out the rubber plug on the drainage pipe to discharge water;
 - Put back the rubber plug onto drainage pipe after finishing discharging water and then fix the pipe on the clip;
 - After full water protection is eliminated and the compressor has been stopped for 3 minutes, the unit will resume operation.

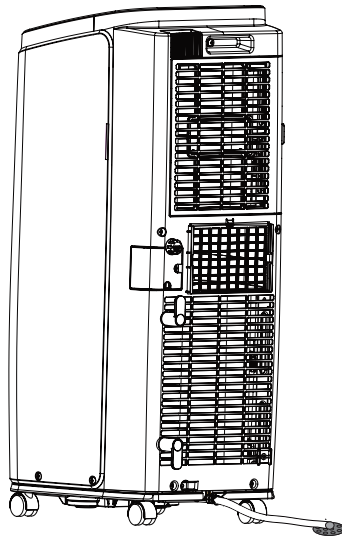

Removing Collected Water

2 Use the continuous drainage option from the middle hole.

Note: Water can be automatically emptied into a floor drain by attaching 14mm inner diameter hose (not included).

1. Remove the continuous drain cap 1 by turning it counter clockwise then remove the rubber stopper 2 from the spout.

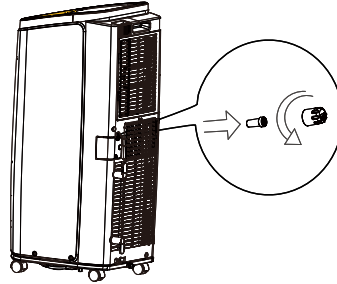

2. Screw the drain connector to (included in the package) the spout by turning clockwise.

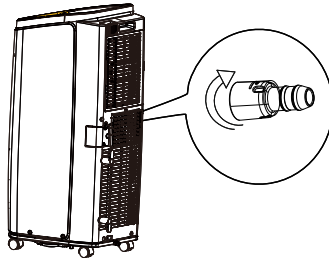

3. Insert the drainage hose into drain connector.

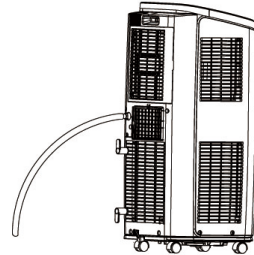

ATTENTION:

When using continuous drainage option from the middle hole, place portable on a level surface and make sure garden hose is clear of any obstructions and is directed downward. Placing portable on an uneven surface or improper hose installation may result in water filling up the chassis and causing the unit to shut off. Empty water in the chassis if shut off occurs, then check portable location and hose for proper setup.

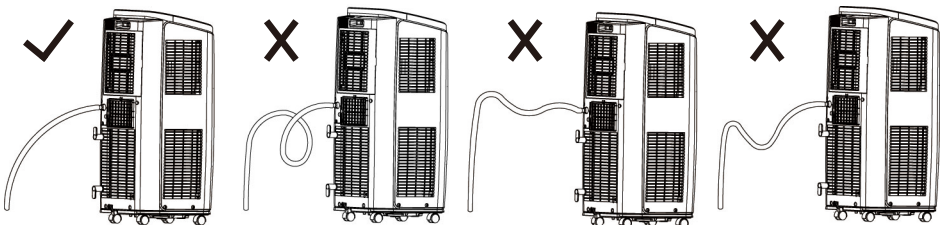

Installation in a double-hung sash window

(Note: If the inner width of window is below 20.5"(520mm), please remove the adjusting panel from window panel and then cut the window panel to make its width the same as the width of window.)

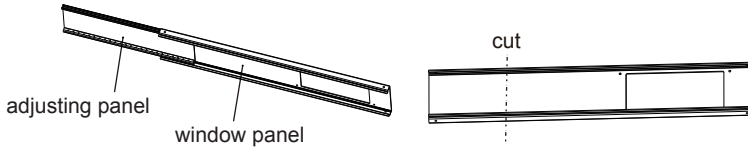

1. Install rear clip — aim the rear clip(upper) at the rear clip(lower),fix them together, press the clasp forcibly in to the groove.

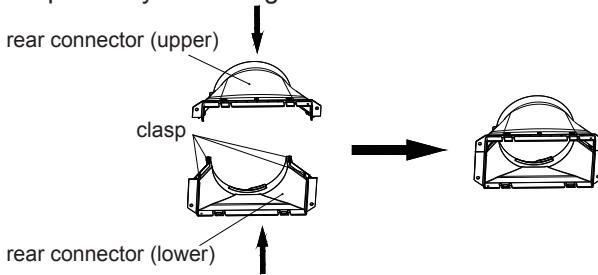

2. Clamp joint B+C into the inner side of window panel along the direction of arrow.

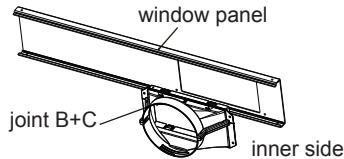

3. Fix the protective grille on joint B+C with screws.

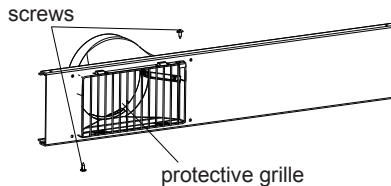

4. Fix the support on the outer side of window panel with nuts, spring washer, washer and bolt.

Installation in a double-hung sash window

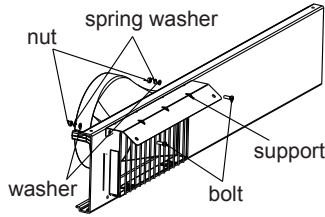

5. Fix the rain shield on the support with nuts, spring washer, washer and bolt.

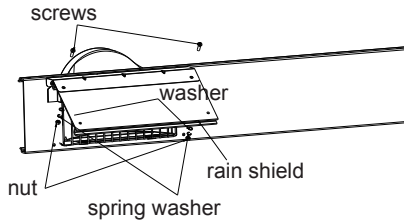

6. Cut the sponge B to a proper length and attach it to the window sash.

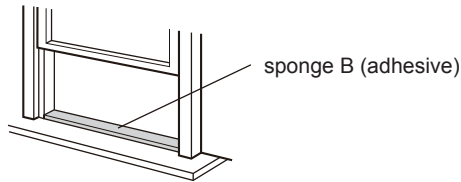

7. Attach the window panel to the window stool.

7.1 If the inner width of the window is less than 20.5"(520mm)

The window panel cannot be installed in windows less than 20.5"(520mm) wide.

- (1) Remove the adjustment panel from the window panel, and cut the window panel to the same width as the window.
- (2) Open the window sash and place the window panel on the window stool.
- (3) Secure the window panel to the window stool with screws.

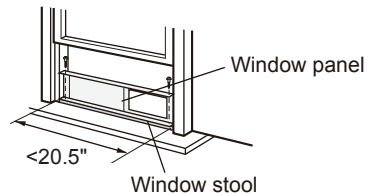
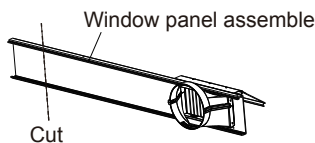
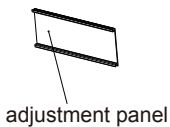

Installation in a double-hung sash window

7.2 If the inner width of the window is between 20.5"(520mm) and 37.4"(950mm) inclusive.

- (1) Open the window sash and place the window panel on the window stool.
- (2) Slide the adjustment panel to fit the window stool width.
- (3) Secure the window panel to the window stool with screws.

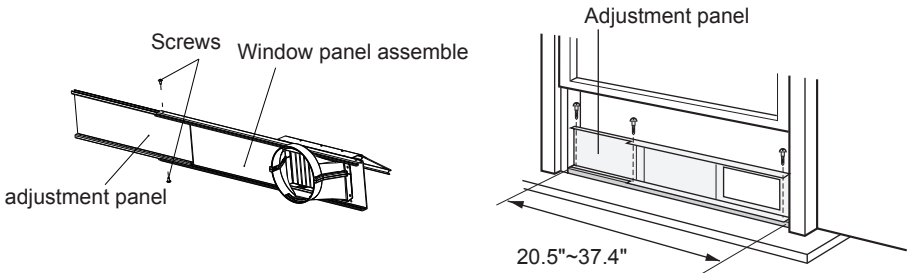

7.3 If the inner width of the window is between 37.4" (950mm) and 56.7" (1440mm) inclusive.

- (1) Attach the extension panel to the adjustment panel.
- (2) Open the window sash and place the window panel on the window stool.
- (3) Slide the adjustment and extension panels to fit the window stool width.
- (4) Secure the window panel to the window stool with screws.

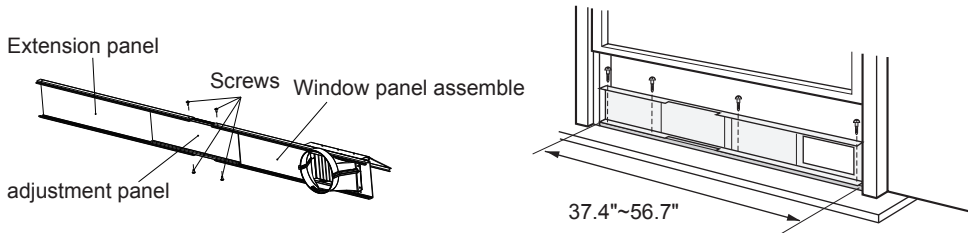

8. Cut the sponge B to a proper length and attach it to the window panel.

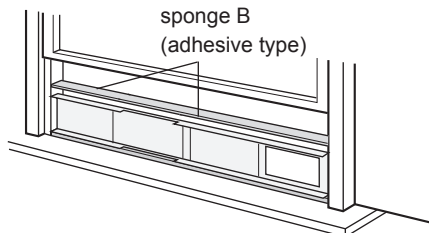

Installation in a double-hung sash window

9. Close the window sash securely against the Window panel.

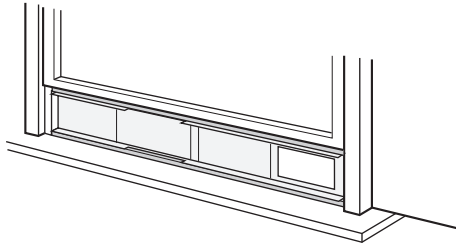

10. Cut the sponge A to a proper length and seal the gap between upper part of inner window sash and outer window sash.

11. Fix the inner window with window bracket and screw, so that it can not slide vertically.

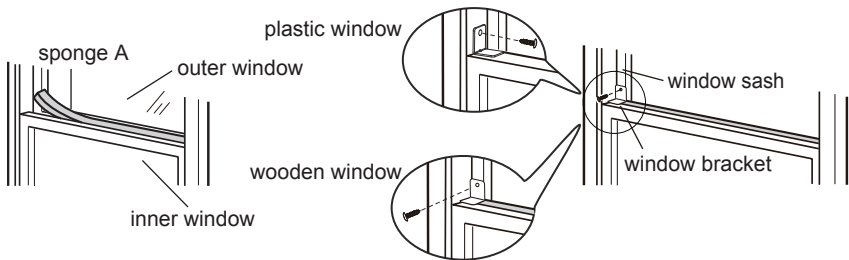

Installation in a sliding sash window

1. Install rear clip — aim the rear clip(upper) at the rear clip(lower),fix them together, press the clasp forcibly in to the groove.

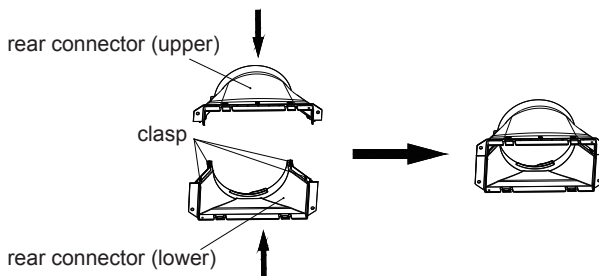

2. Clamp joint B+C into the inner side of window panel along the direction of arrow.

Installation in a sliding sash window

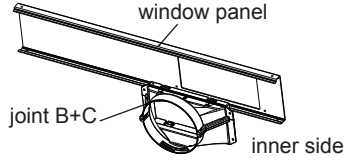

3. Fix the protective grille on joint B+C with screws.

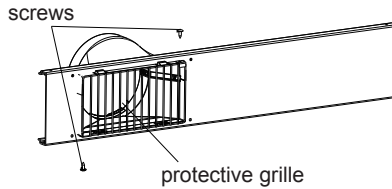

4. Fix the support on the outer side of window panel with nuts, spring washer, washer and bolt.

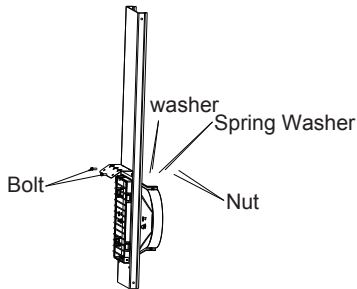

5. Fix the rain shield on the support with nuts, spring washer, washer and bolt.

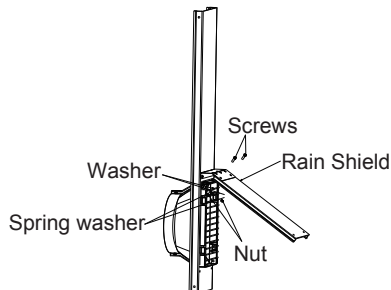

Installation in a sliding sash window

6. Cut the sponge B to a proper length and attach it to the window stool.

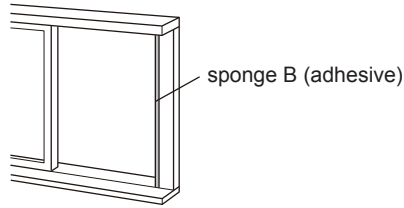

7. Install the window panel into the window stool.

7.1 If the height of the window is less than 20.5"(520mm).

The window panel cannot be installed in windows less than 20.5"(520mm) high.

- (1) Remove the adjustment panel from the window panel, and cut the window panel to the same width as the window.
- (2) Open the window sash and place the window panel on the window stool.
- (3) Secure the window panel to the window stool with screws.

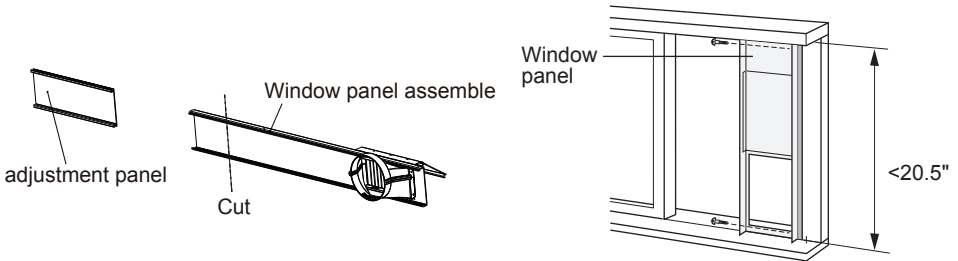

7.2 If the inner width of the window is between 20.5" (520mm) and 37.4"(950mm) inclusive.

- (1) Open the window sash and place the window panel on the window stool.
- (2) Slide the adjustment panel to fit the window stool height.
- (3) Secure the window panel to the window stool with screws.

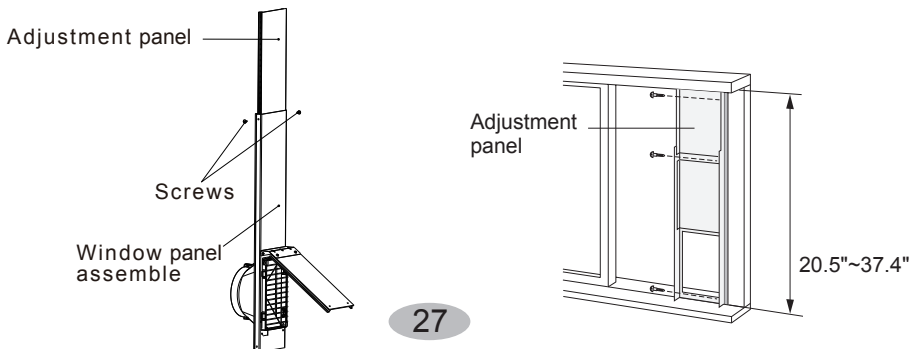

Installation in a sliding sash window

7.3 If the inner width of the window is between 37.4" (950mm) and 56.7" (1440mm) inclusive.

- (1) Attach the extension panel to the adjustment panel.
- (2) Open the window sash and place the window panel on the window stool.
- (3) Slide the adjustment and extension panels to fit the window stool height.
- (4) Secure the window panel to the window stool with screws.

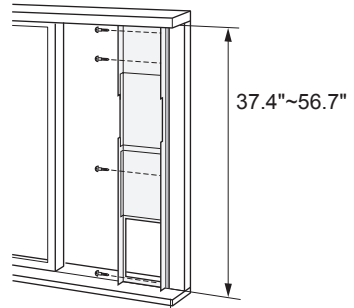
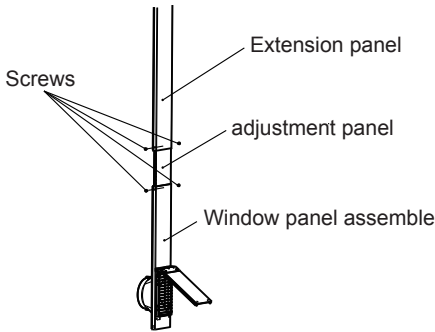

8. Cut the sponge B to a proper length and attach it to the window panel.

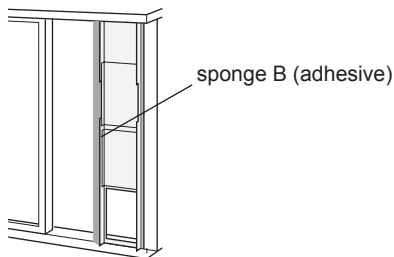

9. Close the window securely against the window panel.

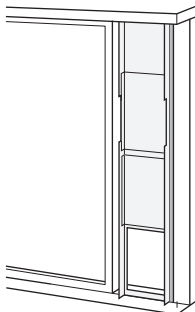

Installation in a sliding sash window

10. Cut the sponge A to a proper length and seal the gap between left side of inner window sash and outer window sash.
11. Fix the inner window with window bracket and screw, so that it can not slide horizontally.

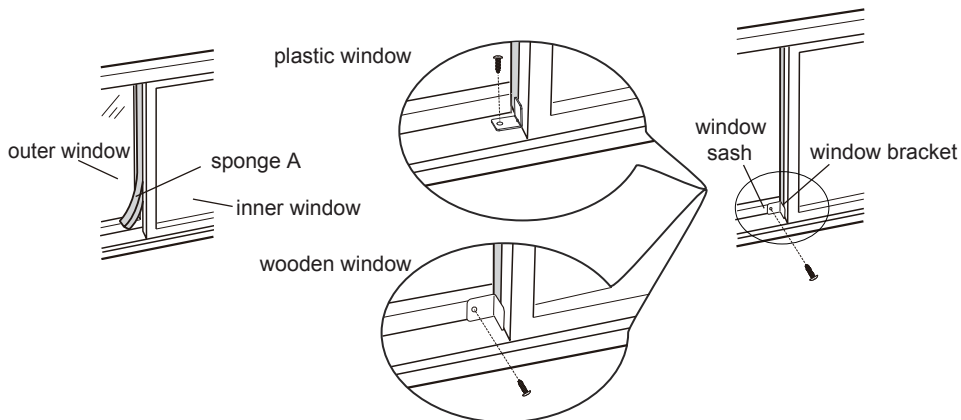

Installation and Disassembly of Heat Discharge Pipe

Install heat discharge pipe

1. Rotate joint A clockwise into the heat discharge pipe.

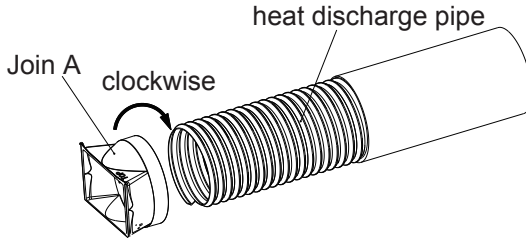

2. Install another side of heat discharge pipe clockwise into protective grille sub-assy.

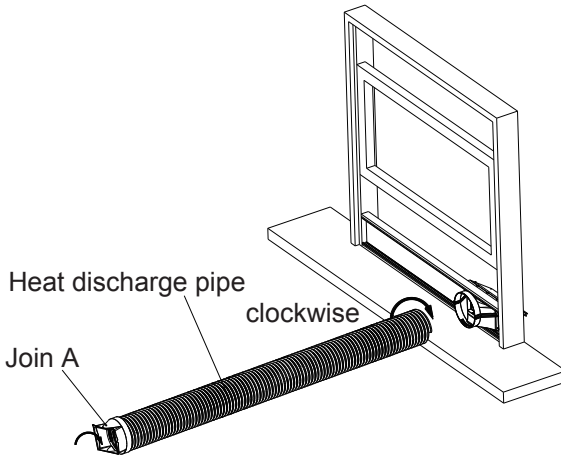

3. Insert joint A of heat discharge pipe (the side with "TOP" is upwards) into the groove until you hear a sound.

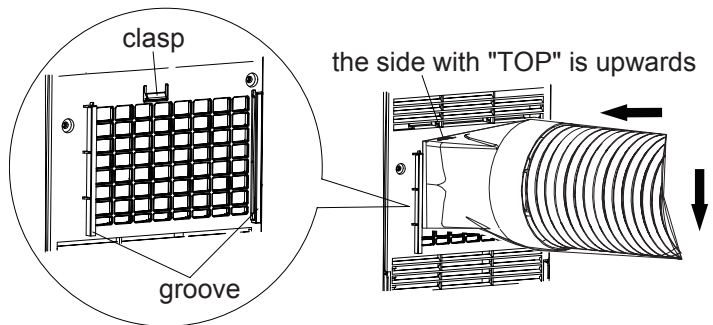

Installation and Disassembly of Heat Discharge Pipe

Note of Installing heat discharge pipe

In order to improve cooling efficiency, the heat discharge pipe should be as short as possible and flat without curve to ensure smooth heat discharge.

The discharge pipe is suggested to be installed according to below figure by the manufacturer.

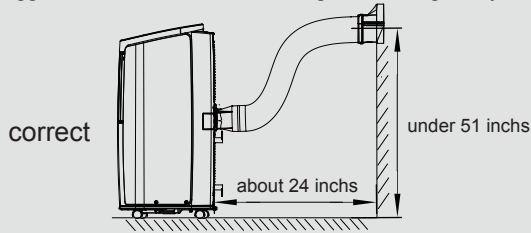

User can adjust the installation method of the discharge pipe basing on the requirement, while the similar installation methods as below which will lead to unsmoothly air-out are not allowed.

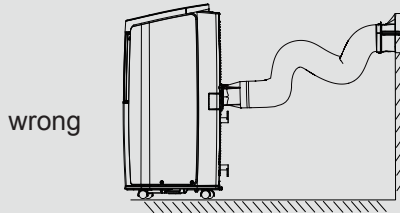

- The length of the heat discharge pipe is less than 40 inches. It is recommended to use it with shortest length.
- When installing, heat discharge pipe should be as flat as possible. Don't prolong the pipe or connect it with other heat discharge pipe.

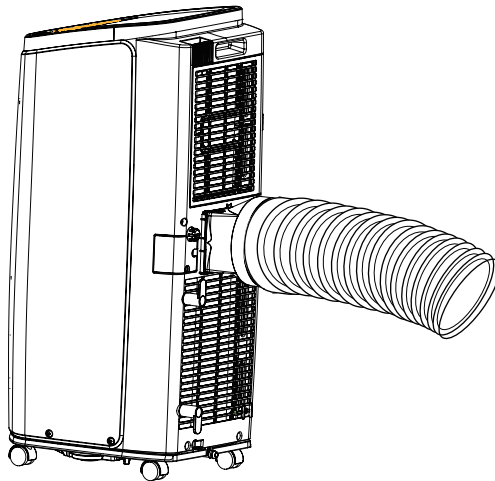

Installation and Disassembly of Heat Discharge Pipe

Disassemble heat discharge pipe

1. Remove joint A:
Press the clasp and lift joint A upwards to remove it.

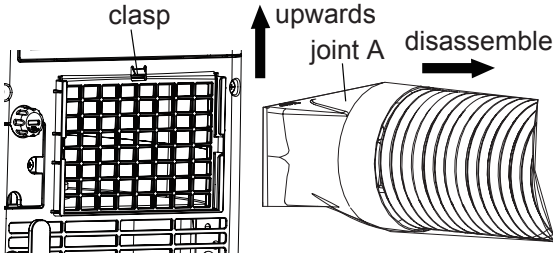

2. Remove heat discharge pipe from protective grille sub-assy.

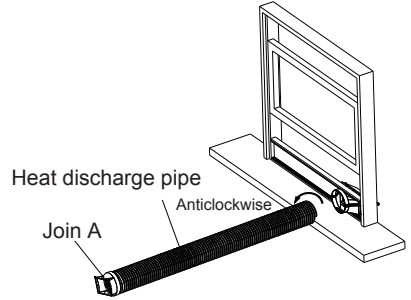

Operation Test

- Put through the power supply and then press ON/OFF button on remote controller to start the unit.
- Press mode button to select auto, cooling, drying, fan or heating function, and then check if the unit operates normally.
- If ambient temperature is below 61°F(16°C), the unit can't operate in cooling mode.

Electric Schematic Diagram

The Electric schematic diagram are subject to change without notice. Please refer to which one on the unit,

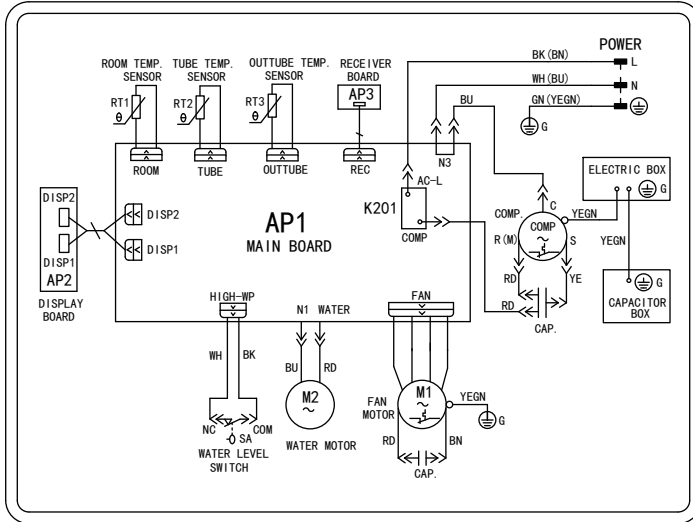

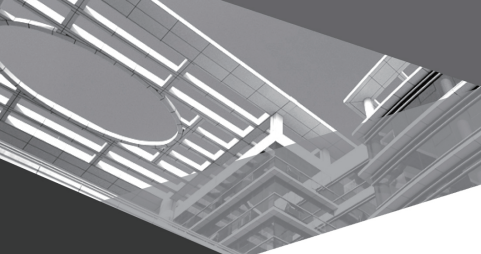

 **GREE**



66129936921