

**ITEM # GCS522014**  
**20 INCH CHAIN + 14 INCH CHAIN**  
**2-CYCLE CHAINSAW**  
**INSTRUCTION MANUAL**



**READ ALL INSTRUCTIONS AND WARNINGS BEFORE USING THIS PRODUCT.**

This manual provides important information on proper operation & maintenance. Every effort has been made to ensure the accuracy of this manual. These instructions are not meant to cover every possible condition and situation that may occur. We reserve the right to change this product at any time without prior notice.

**IF THERE IS ANY QUESTION ABOUT A CONDITION BEING SAFE OR UNSAFE,  
DO NOT OPERATE THIS PRODUCT!**

**ATTENTION: 2-CYCLE OIL AND GASOLINE IS NOT INCLUDED  
WITH THE TOOL AND MUST BE ADDED BEFORE FIRST USE.**

**QUESTIONS OR PROBLEMS? CALL CUSTOMER SERVICE**

If you experience a problem, have questions or need parts for this product, call Customer Service at 1-866-460-9436, Monday-Friday, 8 AM - 4 PM Central Time. A copy of the sales receipt is required.

**FOR CONSUMER USE ONLY – NOT FOR PROFESSIONAL USE. KEEP THIS MANUAL,  
SALES RECEIPT & APPLICABLE WARRANTY FOR FUTURE REFERENCE.**

## FEATURES:

- Chain Pitch: 0.325"
- Chain Length: 20"
- 20 Inch= Number of Drive Links: 76
- Chain Length: 14"
- 14 Inch = Number of Drive Links: 60
- Gauge: 0.058"
- Torque Maximum (Nm): 2.4
- Idle Speed: 2,700-3,400 RPM
- 8,500 RPM
- 52cc
- Fuel mixture: 40:1 (Gasoline / 2-cycle oil) (Mix 18 ounces gasoline together with 0.448 oz of 2-cycle oil)
- Fuel tank capacity (ounces): 18 total ounces
- Safety chain brake is built-in. It stops the chain in seconds to protect the operator
- EPA Approved
- High Altitude Use: This chain saw is not recommended for high altitude use above 3,000 feet.
- If you are using a chain saw above sea level, it may not function properly because of air flow getting through the carburetor.



## SYMBOLS ON THE MACHINE

For safe operation and maintenance, symbols are carved on the chainsaw. Find and identify these symbols:

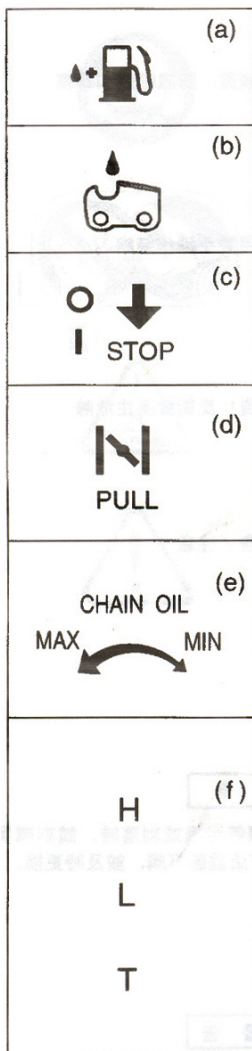

- a. The port to add the "GASOLINE / 2-CYCLE OIL MIXTURE"
- b. The port to add the "CHAIN OIL"
- c. Flip the engine switch to the "I" (stop) direction to stop the engine.
- d. Pull out the choke knob to close the choke
- e. Disregard, as this does not apply to this model.
- f. The position of H-needle  
The position of L-needle  
The position of idle adjusting

## **THIS ENGINE MEETS U.S. EPA EMISSION STANDARDS UNDER 40 CFR 1054.625 .**

### **2 YEAR LIMITED EMISSION-RELATED WARRANTY**

THIS ENGINE MEETS U.S. EPA EMISSION STANDARDS UNDER 40 CFR 1054.625 .The emission-related limited warranty is valid for two (2) years. Keep the purchase receipt and mail in the product registration card for proof of purchase. Buffalo Corp limits emission-related warranty repairs to authorized service centers for owners located within 100 miles of an authorized service center. For owners located more than 100 miles from an authorized service center, Buffalo Corp will, in its sole discretion, either pay for shipping costs to and from an authorized service center, provide for a service technician to come to the owner to make the warranty repair, or pay for the repair to be made at a local non-authorized service center. The provisions of this paragraph apply only for the contiguous states, excluding the states with high-altitude areas identified in 40 CFR part 1068, Appendix III.

To exercise this warranty, DO NOT RETURN TO RETAILER. Instead, call Customer Service toll free at 1-866-460-9436 (email address [info@buffalotools.com](mailto:info@buffalotools.com)) and you will be instructed on where to take the engine for warranty service. Take the chainsaw and proof of purchase (your receipt) to the repair facility recommended by the Customer Service Representative. The warranty does not extend to chainsaws damaged or affected by fuel contamination, accidents, neglect, misuse, unauthorized alterations, use in an application for which the product was not designed and any other modifications or abuse.

### **1 YEAR LIMITED WARRANTY (30 Day Limited Warranty for Commercial and Rental Purpose)**

Chainsaws are warranted to be free from defects in materials and workmanship for a period of 1 YEAR from date of original purchase. Buffalo Corp. is not liable for any indirect, incidental or consequential damages from the sale or use of this product. Any implied warranties are limited to 1 YEAR as stated, or as otherwise stated, in this written limited warranty. Some states do not allow the exclusion or limitation of incidental or consequential damages. Some states do not allow limitation on the length of an implied warranty. Buffalo Corp will repair or replace, at its discretion, any part that is proven to be defective in materials or workmanship under normal use during the 1 YEAR warranty period. Warranty repairs or replacements will be made without charge for parts or labor. Parts replaced during warranty repairs will be considered as part of the original product and will have the same warranty period as the original product. This warranty gives you specific legal rights, and you may have other rights that vary state to state.

# RECOGNIZE SAFETY SYMBOLS, WORDS AND LABELS

## What You Need to Know About Safety Instructions

Warning and Important Safety Instructions appearing in this manual are not meant to cover all possible conditions and situations that may occur. Common sense, caution and care must be exercised when operating or cleaning tools and equipment.

Always contact your dealer, distributor, service agent or manufacturer about problems or conditions you do not understand.



This is the safety alert symbol. It is used to alert you to potential personal injury hazards. Obey all safety messages that follow this symbol to avoid possible injury or death.



DANGER indicates an imminently hazardous situation which, if not avoided, will result in death or serious injury.



WARNING indicates a potentially hazardous situation which, if not avoided, could result in death or serious injury.



CAUTION indicates a potentially hazardous situation which, if not avoided, may result in minor or moderate injury.



CAUTION used without the safety alert symbol indicates a potentially hazardous situation which, if not avoided, may result in property damage.

### **WARNING**

*GASOLINE IS HIGHLY FLAMMABLE AND EXPLOSIVE. YOU COULD BE BURNED OR SERIOUSLY INJURED IF THE GASOLINE IS IGNITED. Before refueling, stop the engine and keep heat, sparks and flame away. Handle fuel only outdoors. Do not fill the fuel tank above the upper limit line. Wipe up spills immediately.*

### **DANGER**

*EXHAUST CONTAINS POISONOUS CARBON MONOXIDE GAS THAT CAN BUILD UP TO DANGEROUS LEVELS IN CLOSED AREAS. BREATHING CARBON MONOXIDE CAN CAUSE UNCONSCIOUSNESS OR DEATH. Never run the generator in a closed or even partly closed area where people may be present.*

### Notice Regarding Emissions:

Engines certified to comply with California and U.S. EPA emission regulations for SORE (Small Off Road Equipment) are certified to operate on regular unleaded gasoline and may include the following emission control systems: Three-Way Catalyst (TWC) (if equipped).

### Legal Requirements:

Federal and/or State Occupational Safety and Health Administration (OSHA) regulations, local codes, and/or ordinances may apply to the intended use of this chainsaw. Consult a qualified electrician, electrical inspector, and/or the local agency having jurisdiction. Some areas require chainsaws to be registered with local utility companies. Additional regulations may apply if this chainsaw will be used at a construction site.

## IMPORTANT SAFETY INSTRUCTIONS

# STOP!

Before using this chainsaw and if you have any questions regarding the hazard and safety notices listed in this manual and/or on this chainsaw, call 1-866-460-9436, Monday - Friday, 8 AM - 4 PM Central Time.

### DANGER

**Carbon Monoxide Gas:** When in operation, the exhaust from this chainsaw contains poisonous carbon monoxide gas. Carbon monoxide gas is both odorless and colorless AND may be present even if you do not see or smell gas. Breathing this poison gas can lead to headaches, dizziness, drowsiness, loss of consciousness and eventually death.

- USE THIS ONLY OUTDOORS IN NON-CONFINED AREAS. DO NOT SECURE THE CHAINSAW WITH A CHAIN OR ROPE, AS THIS WILL MAKE IT DIFFICULT TO MOVE IN AN EMERGENCY.
- Keep at least several feet of clearance on all sides to allow proper ventilation for this chainsaw.

### WARNING

**Flammable Gasoline:** This chainsaw may emit highly flammable and explosive gasoline vapors, which can cause severe burns or even death. A nearby open flame can lead to an explosion even if not directly in contact with gasoline.

- Do not operate this chainsaw near open flame.
- Do not smoke near this chainsaw.
- Always operate this chainsaw on a firm, level surface.

**Gasoline is highly flammable and explosive. Handling fuel can result in serious injury or burns.**

- Always shut down this chainsaw before refueling. Refuel in a well-ventilated area. Keep heat, sparks and flame away while refueling and away from the location where gasoline is stored. Never refuel indoors where gasoline fumes may reach flames and/or sparks.
- Allow this chainsaw to cool for at least 2 minutes before removing the fuel tank cap. Loosen the cap slowly to relieve pressure in the fuel tank. Avoid spilling fuel.
- Do not fill the fuel tank above the upper limit line. Gasoline may expand during operation. Do not fill to the top of the tank.
- Always check for spilled gasoline and immediately wipe it up before starting this chainsaw.
- Empty the fuel tank before storing or transporting this chainsaw.
- Always handle fuel outdoors.
- Before transporting, turn the fuel valve to the "OFF" position and disconnect the spark plug.

### WARNING

**THIS IS NOT A TOY. DO NOT ALLOW CHILDREN TO USE OR PLAY WITH THIS EQUIPMENT.**

### CAUTION

**Usage:** Prolonged exposure to high noise levels can be hazardous to hearing. Always wear ANSI-approved hearing protection when operating or working around the chainsaw when it is running.

**⚠ DANGER**

**High Temperatures:** This chainsaw produces heat when in operation. Temperatures near the exhaust can exceed 150 Degrees Fahrenheit (65 Degrees Celsius).

- Do not touch hot surfaces. Observe all warning placards on this chainsaw denoting hot surfaces.
- Allow this chainsaw to cool for several minutes after use before touching the engine, muffler or other areas that are hot during operation and before storing indoors.
- Hot exhaust may ignite some materials. Keep flammable materials away from this chainsaw.
- Keep at least several feet of clearance on all sides of this chainsaw during operation. Do not enclose this chainsaw in any structure.

Never use the product under circumstances like those described below:

1. When the ground is slippery or when other conditions exist which might make it not possible to maintain a steady posture.
2. At night, at times of heavy fog, or other times when your field of vision might be limited and it would be difficult to gain a clear view of the area.
3. During rain storms, during lightning storms, at times of strong or gale-force winds, or at any other times when weather conditions might make it unsafe to use this products.
- d. Lack of sleep, tiredness, or physical exhaustion results in lower attention spans, and this in turn leads to accidents and injury. Limit the amount of time of using the machine continuously to somewhere around 10 minutes per session, and take 10~20 minutes of rest between work sessions. Also try to keep the total amount of work performed in a single day under 2 hours or less.

# PACKAGE CONTENTS

The following items are supplied with this Portable Chainsaw. Verify that all items are included.

# STOP!

If there are missing items, call 1-866-460-9436, Monday - Friday, 8 AM - 4 PM Central Time for customer service.

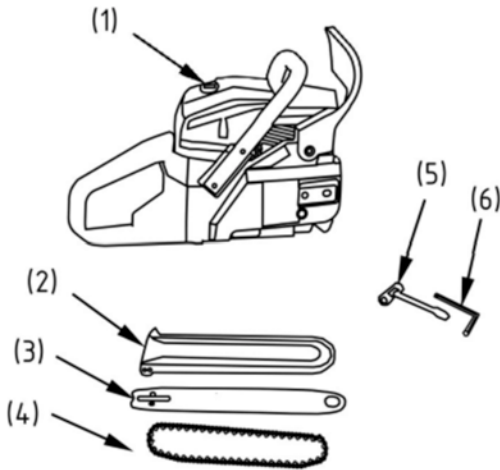

- 1) Chain Saw
- 2) Bar protector
- 3) Guide bar
- 4) Chain
- 5) Spark Plug Wrench
- 6) Hexagon Wrench

## GUIDE BAR INSTALLATION

NOTE: BEFORE REMOVING CHAIN COVER, YOU MUST UNLOCK THE CHAIN.

To unlock chain brake, pull up the front guard toward the front handle until a "click" sound is heard.

- (1) Brake
- (2) Unlocked
- (3) Locked

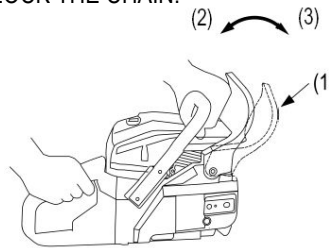

Install the guide bar and the saw chain on the unit as follows:

- a. Loosen the nuts and remove the chain cover.
- b. While fitting the saw chain around the guide bar, mount the guide bar to the unit. Adjust the position of chain tensioner nut on the chain cover to the lower hole of guide bar.

- (1) Tensioner nut
- (2) Chain cover

NOTE: Pay attention to the correct direction of the saw chain (See image A "Direction")

- a. Mount the bar to the studs of the unit, and fit the saw chain around the guide bar, adjust the position of chain tensioner nut on the chain

- b. Tighten the tensioner screw. (See image "Style 2")

- (1) Tighten
- (2) Loosen
- (3) Tensioner screw

NOTE: A new chain will expand its length at the beginning of use. Check and readjust the tension frequently, as a loose chain can easily derail or cause rapid wear of itself and the guide bar.

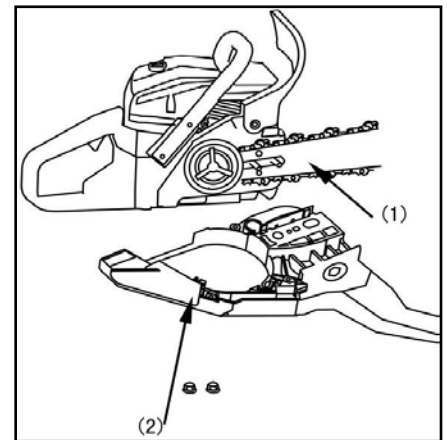

(A) Direction

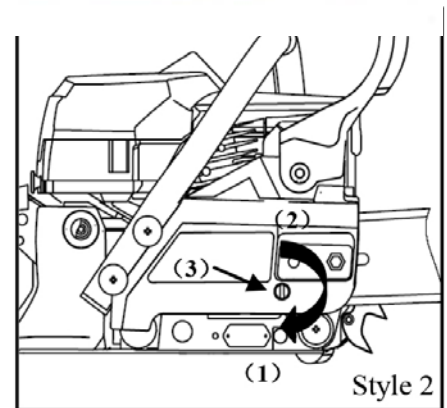

Style 2

## HOW TO MIX FUEL

This chainsaw is equipped with a two-stroke engine and is powered by a fuel mixture. Use only a mix of unleaded gasoline and two-stroke oil in a ratio of 40:1. The chainsaw is delivered without fuel mixture and must be filled prior to start-up operation. **Attention!** Always add fuel mixture when the chainsaw is switched off. Ensure that the fuel switch is in the "OFF" position. Open the tank cover and fill it with max. 18 ounces of the combined fuel mixture. Do not overfill the tank. Close the tank lid carefully.

**ADD OIL/GASS MIXTURE BEFORE USE:** Mix 18 ounces gasoline with 0.448 oz. 2-cycle engine oil (this is the 40:1 ratio) in a separate container, then pour into fuel tank.

## WARNING

**Gas and gas fumes are flammable and explosive. Handling fuel can result in serious injury or burns.**

- Do not fill the fuel tank near heat, sparks or an open flame.
- Always allow several minutes for the engine to cool before refueling.
- Do not overfill the fuel tank. Check for fuel spills and immediately wipe them up. Spilled fuel is a fire hazard.
- Make sure to use gasoline with a minimum octane number of 87 .
- Move at least 10 feet away from the fueling point before starting the engine.

### FUELING THE UNIT

- a. Remove the fuel cap.
- b. Put fuel into the fuel tank to 80% of the full capacity.
- c. Fasten the fuel cap securely and wipe up any fuel spillage around the unit.

### CHAIN OIL

Use Bar and Chain Oil.

## 6. OPERATING THE ENGINE

### ■ STARTING ENGINE

- A. Be certain the fuel and chain oil tanks have been filled and caps tightened. (IMAGE A, #1 and #2)
- B. Put the switch to "ON" position. (IMAGE B)
- C. Pull out the choke knob to the second-stage position. The choke will close and the throttle lever will then be set in the starting position.
- D. Press the Primer Bulb 8-10 times. (IMAGE D)
- E. While holding the saw unit securely on the ground, pull the starter rope vigorously. (IMAGE E)

**DANGER! Do not start the engine while holding the chain saw with your hand.**

- F. Allow the engine to warm-up with the throttle lever pulled slightly. When the throttle levels out, return the choke knob to the run position. (IMAGE F)
- G. Only when you are prepared to begin cutting wood, grip the throttle trigger and the trigger release at the same time to engage the chain. (IMAGE G)

**Keep clear of the saw chain, as it will immediately start rotating upon starting of engine.**

### ■ CHECK CHAIN OIL LEVEL

After starting the engine, run the chain at medium speed and see if chain oil is scattered off as shown (IMAGE H).

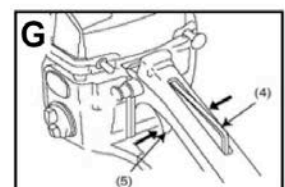
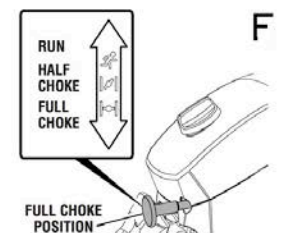
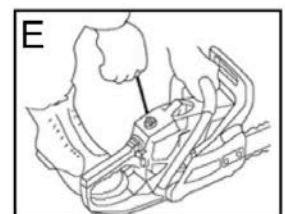
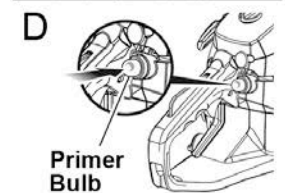
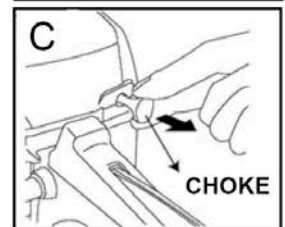
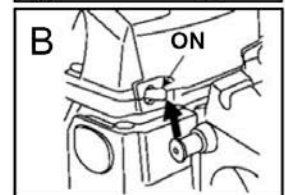
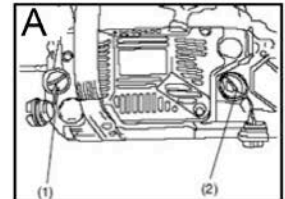
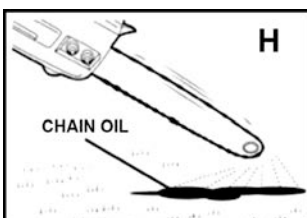



## ■ CHAIN BRAKE

To release brake, pull front guard up toward the front handle until a “click” sound is heard. (IMAGE J)

- (1) Break
- (2) Released
- (3) Operated

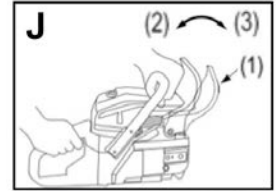

## ■ STOPPING THE ENGINE

1. Release the throttle lever to allow the engine idling for a few minutes.
2. Put the switch to the “0” (stop) position.

## 7. SAWING

- It is not necessary to force the saw into the cut. Apply only light pressure while running the engine at full throttle.
- When the saw chain is caught in the cut, do not attempt to pull it out by force, but use a wedge or a lever to open the way.

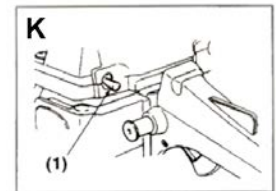

## ■ GUARD AGAINST KICKBACK

This saw is equipped with a chain brake that will stop the chain in the event of kickback if operating properly. You must check the chain break operation before each usage by running the saw at full throttle for 1-2 seconds and pushing the front hand guard forward. (IMAGE L)

The chain should stop immediately with the engine at full speed. If the chain is slow to stop or does not stop, replace the brake band and clutch drum before use.

It is extremely important that the chain brake be checked for proper operation before each use and that the chain be sharp in order to maintain the kickback safety leveled the saw. Removal of the safety devices, inadequate maintenance, or incorrect replacement of the bar or chain may increase the risk of serious personal injury due to kickback.

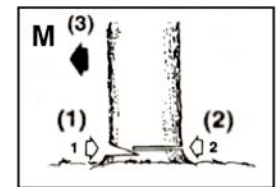
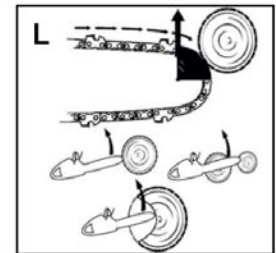

## ■ FELLING A TREE

- a. Decide the felling direction considering the wind, lean of the tree, location of heavy branches, ease of job after felling and other factors.
- b. While cleaning the area around the tree, arrange a good foothold and retreat path.
- c. Make a notch cut the one-third of the wood into the tree on the felling side.
- d. Make a felling cut from the opposite side of the notch and at a level slightly higher than the bottom of the notch. (IMAGE M)

When you fell a tree, warn all coworkers and neighbors of the danger.

- (1) Notch cut
- (2) Felling cut
- (3) Felling direction

## ■ Bucking and Limbing

- Always ensure your foothold. Do not stand on the log.
- Be alert to the rolling over of a cut log. When working on a slope, stand on the uphill side of the log.
- Follow the instructions in “**For Safe Operation**” to avoid kickback of the saw.

### ○ A log lying on the ground (IMAGE N)

Saw down halfway, then roll the log over and cut from the opposite side.

### ○ A log hanging off the ground (IMAGE O)

In area A, saw up from the bottom one-third and finish by sawing down from the top. In area B, saw down from the top one-third and finish by sawing up from the bottom.

### ○ Cutting limb of Fallen Tree (IMAGE P)

First check to see which side of the limb is bent. Then make the initial cut from the bent side and finish by sawing from the opposite side.

### ○ Pruning of Standing Tree (IMAGE Q)

Cut up from the bottom (1), finish down from the top (2).

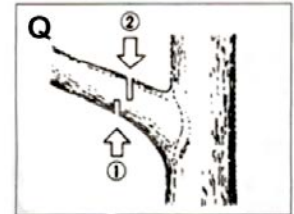
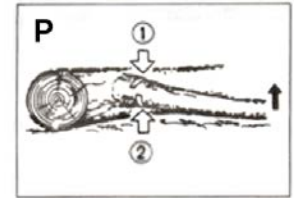
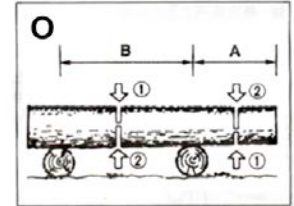
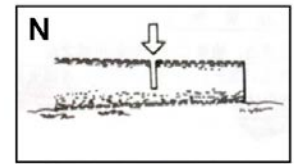

## MAINTENANCE/CARE

Proper routine maintenance of this chainsaw is essential for safe, economical, and trouble-free operation. It will help prolong the life of this chainsaw as well as help reduce air pollution.

### **CAUTION**

**Never perform maintenance procedures while this chainsaw is running. Allow this chainsaw to cool before commencing any maintenance procedures. Keep heat, sparks and flame away.**

### **WARNING**

**Improper maintenance and/or failure to correct any problems prior to operating this chainsaw can cause a malfunction which could cause death or serious injury. Always follow the inspection and maintenance recommendations and schedules in this manual.**

Before cleaning or repairing your unit, make sure that engine has stopped and is cool. Disconnect the spark plug to prevent accidental starting.

#### a. Air Filter

**To clean dirt in the meshes, split the cleaner in half using a screwdriver.**

#### b. Oiling port (IMAGE R)

**Dismount the guide bar and check the oiling port for clogging.**

##### (1) Oiling port

##### c. Guide bar

**When the guide bar is dismantled, remove sawdust in the bar groove and the oiling port. Grease the nose sprocket from the feeding port on the tip of the bar.**

##### (1) Oiling port

##### (2) Grease port

##### (3) Sprocket

#### a. Cylinder fins

Dust clogging between the cylinder fins will cause over heating of the engine. Periodically check and clean the cylinder fins after removing the air cleaner and the cylinder cover. Be sure to block the air intake hole.

#### b. Fuel filter

a. Using a wire hook, take out the filter from the filler port.

b. Disassemble the filter and wash with gasoline.

##### (1) Fuel filter

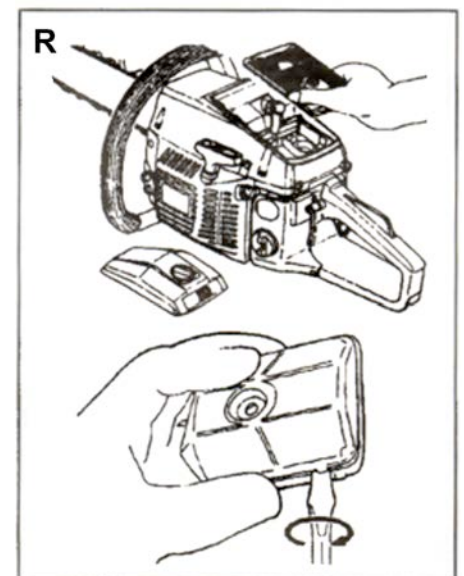

c. Oil tank

With a wire hook, take out the oil filter through the filler port and clean in gasoline. When putting the filter back into the tank, make sure that it comes to the front right corner. Also clean off dirt in the tank. (IMAGE S)

d. Spark plug

Clean the electrodes with a wire brush (IMAGE T) and reset the spark plug gap to 0.6~0.7 mm as necessary. (IMAGE U)

e. Sprocket

Check for cracks and for excessive wear interfering with the chain drive. If the wearing is found, replace it with new one. Never fit a new chain on worn sprocket, or a worn chain on a new sprocket.

It is very important for smooth and safe operation to keep the cutters sharp.

a. Your cutters need to be sharpened when:

- Sawdust become powder-like.
- You need extra force to saw in.
- The cut way does not go straight.
- Vibration increases.
- Fuel consumption increases.

b. Cutter setting standards:

- Make sure the saw chain is held securely.
  - Make sure the engine is stopped.
  - Use a round file of proper size for your chain.
- Place your file on the cutter and push straight forward.  
Keep the file position as illustrated.

After every cutter has been set, check the depth gauge and file it to the proper level as illustrated.

Round off the front edge to reduce the chance of kickback or tie-strap breakage (IMAGE V).

- (1) Appropriate gauge checker
- (2) Make the shoulder round
- (3) Depth gauge standard

Make sure every cutter has the same length and edge angles. (IMAGE W)

- (4) Cutter length
- (5) Filing angle
- (6) Side plate angle
- (7) Top plate cutting angle

■ GUIDE BAR

Reverse the bar occasionally to prevent partial wear.

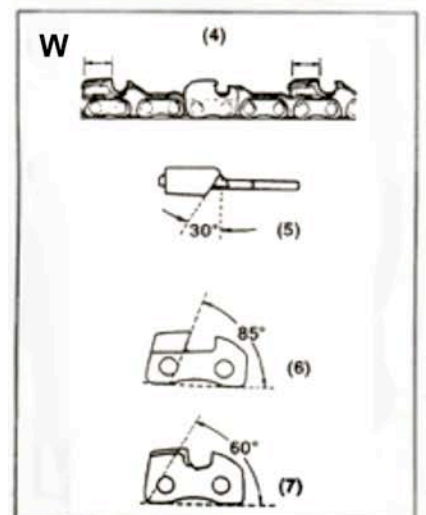
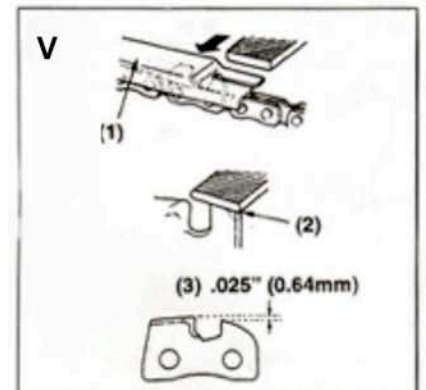
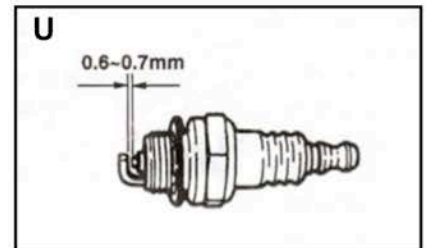
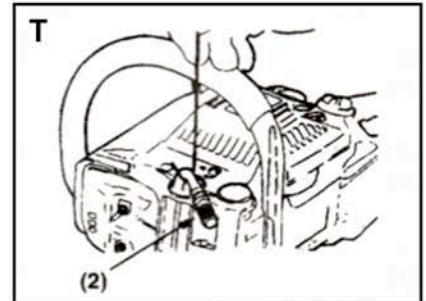
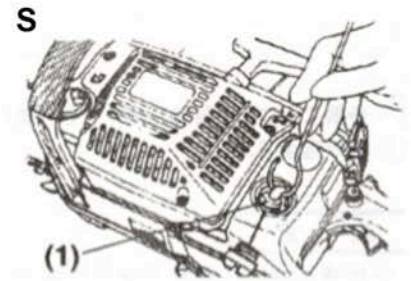

## Spark Plug Maintenance

The spark plug is essential for proper engine operation. The spark plug should be intact, free of deposits, and properly gapped. A bad or incorrectly installed spark plug can cause engine damage. To inspect the spark plug:

1. Remove the spark plug by pulling on the spark plug cap.
2. Unscrew the spark plug from this chainsaw by using the included spark plug wrench.
3. Inspect the spark plug. If it is cracked and/or chipped, install a new spark plug. A RCJ6Y spark plug is recommended.
4. Measure the spark plug electrode gap with a gauge. The gap should be (0.023 - 0.027 inches) (0.6~0.7 mm).
5. If re-using the spark plug, use a wire brush to clean any dirt from around the spark plug base and then re-gap the spark plug.
6. Screw the spark plug back into place on this chainsaw by using the included spark plug wrench.
7. Replace the spark plug cap.

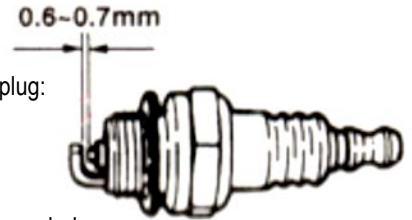

## Cleaning the Air Filter

Routine maintenance of the air filter helps maintain proper airflow to the carburetor. Occasionally verify that the air filter is free of excessive dirt. The air filter will require more frequent cleaning when operating this chainsaw in extremely dusty areas.

To clean the air filter, remove the foam filter element from the chainsaw and wash it in warm water and household dish detergent. Thoroughly rinse and dry. Pour a small amount of motor oil onto the filter, ring out ALL excess oil, and reinstall the foam filter element in the chainsaw.

To locate the air filter, unscrew the two bolts attaching the bottom air filter cover, located below the choke lever, to access the foam filter element.

## Emptying the Carburetor

To store this chainsaw for extended time, the fuel needs to be drained from the carburetor.

## Modifying the Carburetor

The carburetor is factory set and CANNOT be modified.

To drain the fuel from the carburetor, turn the fuel valve to the "off" position while the engine is running. The chainsaw will shut down when all the gasoline in the carburetor has been used.

### **⚠ CAUTION**

Do not store gasoline for more than 3 months.

## STORAGE/TRANSPORT PROCEDURES

### **⚠ CAUTION**

Never place any type of storage cover on this chainsaw while it is still hot.

When transporting or storing this chainsaw for extended time:

- Allow chainsaw to fully cool before moving it. A hot engine and exhaust system can burn you and ignite some materials.
- Empty the fuel tank. (See "Emptying the Fuel Tank" in the "Maintenance/Care" section.)
- Turn the fuel valve to the "off" position.
- Disconnect the spark plug.
- Do not obstruct any ventilation openings.
- Do not drop or strike this chainsaw while moving it.
- Store this chainsaw in a cool dry area, free of excessive dust.

Storage Time	Recommended Storage Procedure (which will help prevent difficult starts)
Less than 1 month	No storage procedure required.
1 to 2 months	Fill with fresh gasoline and add gasoline conditioner
2 months to 1 year	Empty the fuel tank. (See "Emptying the Fuel Tank" in the "Maintenance/Care" section.)
1 year or more	Empty the fuel tank. (See "Emptying the Fuel Tank" in the "Maintenance/Care" section.) Disconnect the spark plug.

# PARTS DIAGRAM

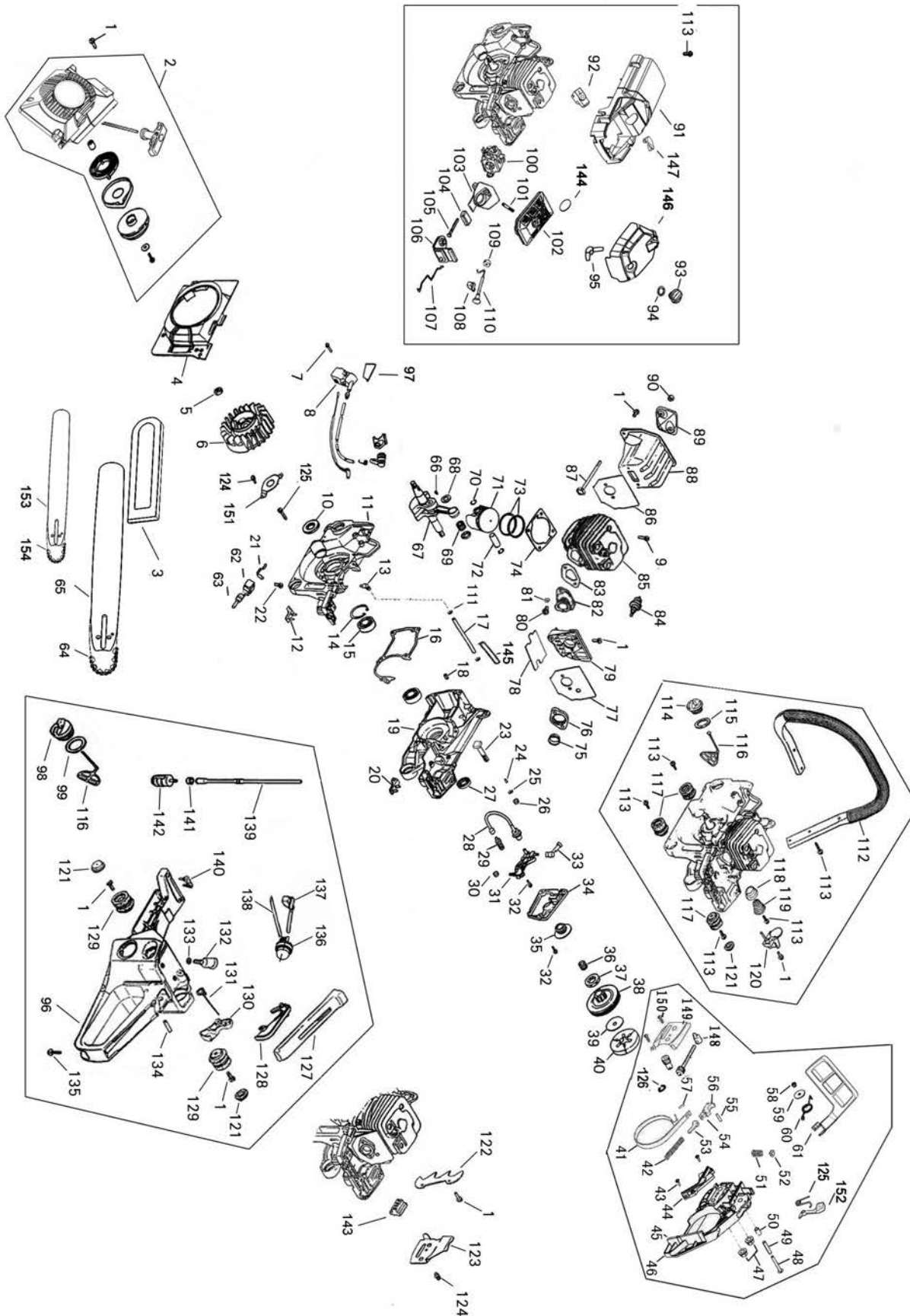

## PARTS LIST

NO	Part No	name	Qty
1	03010110073	screw M5X16	18
2	70080100063	Starter	1
3	70030030892	chain cover	1
4	70030140064	inner cover	1
5	03030050012	nut M8X1	1
6	02050030360	rotor	1
7	03010010061	screw M5X20	2
8	02050030361	stator	1
9	03010080023	screw M5X25	4
10	03100010021	oil seal 15*35*4.5	1
11	70070050139	left crankcase	1
12	02080020158	rubber gasket 4	1
13	02020160263	connector	1
14	03120020004	stop ring $\phi$ 35	1
15	03090010016	bearing	2
16	02070010132	crankcase gasket	1
17	02080020141	pipe	1
18	03060010009	pin 6X12	2
19	70070050095	right crankcase	1
20	02080020148	rubber gasket 2	1
21	02050050366	plate	1
22	03020020017	screw M5X10	1
23	03010050012	bolt M8X25	2
24	02080040014	inlet valve	1
25	02020030016	stop ring	1
26	02090010038	small sponge	1
27	03100010026	oil seal 12*28*4.5	1
28	02080060007	inlet oil pipe	1
29	02050120015	chain oil cleaner	1
30	02090010039	big sponge	1
31	02050130007	oil pump	1
32	03020020028	screw M4X16	5
33	02080060006	outlet oil pipe	1
34	70030030365	pump cover	1
35	70030180529	screw plug	1
36	03090020016	needle bearing	1
37	02050110045	chain wheel	1
38	02020050054	clutch	1
39	02020160782	gasket	1
40	02050230009	expander	1
41	02020110091	brake plate	1
42	02020110075	long spring	1
43	03010040051	screw ST4. 2X12	2
44	70030030092	spring cover	1
45	02080050049	baffler	1

NO	Part No	name	Qty
46	70030031142	clutch cover	1
47	03030050009	NUT M8X1	2
48	03020020037	screw	1
49	02020160348	steel bushing	1
50	70030180127	plastic bushing	1
51	02020110074	press spring	1
52	02020160381	gasket	1
53	02020160382	push rod	1
54	70030180007	lever 1	1
55	03060010008	pin	1
56	70030180009	lever 2	1
57	03060010012	pin	3
58	03030060007	nut	1
59	03040050065	big washer	1
60	02020110133	spring	1
61	70030160153	brake handle	1
62	02080020131	rubber cover	1
63	02050050365	stop switch	1
64	02050110052	chain	1
65	02050110171	guide plate	1
66	03070010003	key 3*3.7*10	1
67	02020120133	crankshaft	1
68	02020150005	stop ring	2
69	03090020027	needle bearing	1
70	02020030015	snap ring	2
71	02010020060	piston	1
72	02020010016	piston pin	1
73	02020020036	piston ring	2
74	02070010276	cylinder gasket	1
75	02020160521	washer	1
76	70030020017	connector pipe	1
77	02500010076	plate 1	1
78	02500010075	plate 2	1
79	70030180204	carburetor gasket	1
80	03010060066	screw M5X14	2
81	03040020019	washer 5	2
82	02080060011	inlet pipe	1
83	02070010094	inlet pipe gasket	1
84	03130010013	spark plug	1
85	70070130082	cylinder	1
86	02070010275	muffler gasket	1
87	03010110192	screw M5X82	2
88	02050010266	muffler	1
89	02050010267	muffler plate	1
90	03030070059	nut M5	2



## PARTS LIST

NO	Part No	name	Qty
91	70030031557	cylinder cover	1
92	02080020164	rubber cover	1
93	70030180130	knob 1	1
94	70030180545	washer	1
95	70030180553	knob 2	1
96	70080120512	frame	1
97	02080020031	washer	1
98	70030060029	fuel tank lid	1
99	02070020047	lid washer	1
100	02050020373	carburetor	1
101	03010050017	bolt	1
102	70030180554	air filter assy	1
103	70070090007	connector	1
104	02070020010	rubber gasket	1
105	03020020046	screw M5X50	2
106	02080050031	rubber gasket 1	1
107	02020160765	throttle rod	1
108	02080050024	gasket	1
109	02070020008	rubber gasket	1
110	70030180068	choker rod	1
111	02020110132	spring	2
112	02020160859	left handle	1
113	03010040047	screw NST5X16	8
114	70030060005	oil tank lid	1
115	02070020016	gasket	1
116	70030180064	anti-chain	2
117	02080030030	rubber plug	3
118	70030180019	spring washer	1
119	02020110137	spring	1
120	70030180681	spring plate	1
121	70030060008	plastic cover 2	5
122	02020070914	teeth	1
123	02020160783	chain baffle	1
124	03010060058	screw M4X10	3
125	02020110069	spring	5
126	02020030022	snap ring	1
127	70030160098	right handle upper cover	1
128	70030180092	connecting rod	1
129	02080030021	rubber plug 2	2
130	70030180083	refuel handgrip	1
131	02020110135	spring	1
132	02110030281	screw 4.2X15	1
133	02070020051	washer	1
134	03060030015	pin shaft	1
135	03010040056	screw NST5X20	1
136	02050020127	prim pump	1
137	01040010058	fuel pipe	0.15

NO	Part No	name	Qty
138	01040010014	oil pipe	1
139	01040010062	oil pipe	1
140	02080050027	rubber gasket	1
141	02020160526	steel bushing	1
142	02050120004	fuel cleaner	1
143	70030180125	plastic gasket	1
144	03110020009	O ring	1
145	01040020009	insulator	1
146	70030031558	air cleaner cover	1
147	02080020138	rubber gasket	1
148	02020090149	adjusting assy	1
149	02020160789	baffler	1
150	03010040008	screw	2
151	02020160399	washer	1
152	70030180144	The weight	1
153	02050110176	guide plate 14 inch	1
154	2050110177	chain 14 inch	1

## EMISSIONS CONTROL WARRANTY STATEMENT

### YOUR WARRANTY RIGHTS AND OBLIGATIONS

United States Environmental Protection Agency (EPA), and Buffalo Corp are pleased to explain the emissions control system warranty on your 2020 small off road engine (SORE). Buffalo Corp must warrant the emissions control system on your SOREs for the periods of time listed below provided there has been no abuse, neglect or improper maintenance of your SOREs. Your emission control system may include parts such as the carburetor, fuel tanks, fuel caps, fuel lines, the ignition system, and catalytic converter. Also included may be hoses, belts, clamps, connectors and other emission related assemblies. Where a warrantable condition exists, Buffalo Corp. will repair your small off-road engine at no cost to you including diagnosis, parts and labor.

### MANUFACTURER'S WARRANTY COVERAGE:

The emissions control system is warranted for two years. If any emissions related part on your engine is defective, the part will be repaired or replaced by Buffalo Corp.

### OWNER'S WARRANTY RESPONSIBILITIES:

As the SORE owner, you are responsible for the performance of the required maintenance listed in your owner's manual. Buffalo Corp. recommends that you retain all receipts covering maintenance on your SORE, but Buffalo Corp. can not deny warranty solely for the lack of receipts or for your failure to ensure the performance of all scheduled maintenance. As the SORE owner, you should however be aware that Buffalo Corp. may deny your warranty coverage if your SORE or a part has failed due to abuse, neglect, improper maintenance or unapproved modifications.

You are responsible for presenting your SORE to distribution center or service center authorized by Buffalo Corp. as soon as the problem exists. The warranty repairs should be completed in a reasonable amount of time, not to exceed 30 days. If you have any questions regarding your warranty coverage, you should contact Buffalo Corp. customer service representative at:

Tell : 1-866-460-9436

Email : [info@buffalotools.com](mailto:info@buffalotools.com)

### DEFECTS WARRANTY COVERAGE

Adopted by the Air Resources Board, Buffalo Corp. warrants to the ultimate purchaser and each subsequent purchaser that the small off-road engine (SORE) (1) has been designed, built and equipped so as to conform with all applicable regulations; and (2) is free from defects in materials and workmanship that cause the failure of a warranted part to conform with those regulations as may be applicable to the terms and conditions stated below.

(A) The warranty period begins on the date the engine is delivered to an ultimate purchaser. The warranty period is two years.

(B) Subject to certain conditions and exclusions as stated below, the warranty on emissions related parts is as follows:

(1) Any warranted part that is not scheduled for replacement as required maintenance in your Owner's Manual is warranted for the warranty period stated above. If the part fails during the period of warranty coverage, the part will be repaired or replaced by Buffalo Corp. according to Subsection (4) below. Any such part repaired or replaced under warranty will be warranted for the remainder of the period.

(2) Any warranted part that is scheduled only for regular inspection in your Owner's Manual is warranted for the warranty period stated above. Any such part repaired or replaced under warranty will be warranted for the remaining warranty period.

(3) Any warranted part that is scheduled for replacement as required maintenance in your Owner's Manual is warranted for the period of time before the first scheduled replacement date for that part. If the part fails before the first scheduled replacement, the part will be repaired or replaced by Buffalo Corp., according to Subsection (4) below. Any such part repaired or replaced under warranty will be warranted for the remainder of the period prior to the first scheduled replacement point for the part.

(4) Repair or replacement of any warranted part under the warranty provisions herein must be performed at a warranty station at no charge to the owner.

(5) Notwithstanding the provisions herein, warranty services or repair will be provided at all of our distribution centers that are franchised to service the subject engines.



- (6) The engine owner must not be charged for diagnostic labor that leads to the determination that a warranted part is in fact defective, provided that such diagnostic work is performed at a warranty station.
- (7) Buffalo Corp. is liable for damages to other engine components proximately caused by a failure under warranty of any warranted part.
- (8) Throughout the engine warranty period stated above, Buffalo Corp. will maintain a supply of warranted parts sufficient to meet the expected demand for such parts.
- (9) Any replacement part may be used in the performance of any warranty maintenance or repairs and must be provided without charge to the owner. Such use will not reduce the warranty obligations of Buffalo Corp.
- (10) Add-on or modified parts that are not exempted by the Air Resources Board may not be used. The use of any non-exempted add-on or modified parts by the ultimate purchaser will be grounds for disallowing a warranty claims. Buffalo Corp. will not be liable to warrant failures of warranted parts caused by the use of a non-exempted add-on or modified part.
- (11) The manufacturer issuing the warranty shall provide any documents that describe that manufacturer's warranty procedures or policies within five working days of request by the Air Resources Board.

### **EMISSION WARRANTY PARTS LIST**

The repair or replacement of any warranted part otherwise eligible for warranty coverage may be excluded from such warranty coverage if Buffalo Corp. demonstrates that the engine has been abused, neglected, or improperly maintained, and that such abuse, neglect, or improper maintenance was the direct cause of the need for repair or replacement of the part. That notwithstanding, any adjustment of a component that has a factory installed, and properly operating, adjustment limiting device is still eligible for warranty coverage. The following emissions warranty parts for each engine family list is covered.

For engine family:

- (1) Fuel Metering System:
  - (a) Gasoline carburetor assembly and its internal components
  - (b) Carburetor gaskets
  - (c) Fuel tank
  - (d) Fuel Line
  - (e) Fuel Line Fittings
  - (f) Clamps
- (2) Air Induction System including:
  - (a) Intake pipe/manifold
  - (b) Air cleaner
- (3) Ignition System including:
  - (a) Spark plug
  - (b) Ignition coil
- (4) Catalytic Muffler Assembly (if so equipped) including:
  - (a) Muffler gasket
  - (b) Exhaust manifold
  - (c) Catalytic converter
- (5) Crankcase Breather Assembly including:
  - (a) Breather connection tube.
- (6) Fuel tank evaporative emissions control system including:
  - (a) Purge Valves
  - (b) Carbon Canister (if equipped)
  - (c) Canister Mounting Brackets (if equipped)
  - (d) Fuel Cap
  - (e) Fuel Tank
- (7) Miscellaneous items Used in Above Systems including:
  - (a) Switches
  - (b) Hoses, belts, connectors, and assemblies.
- (8) Air injection system (if equipped)
  - (a) Pulse valve

# FOR SAFE OPERATION

## Chain Saw Safety

Operating a chain saw is inherently hazardous. Potential injuries can be minimized by using proper personal protective equipment and safe operating procedures.

### Before Starting a Chain Saw

- Check controls, chain tension, and all bolts and handles to ensure that they are functioning properly and that they are adjusted according to the manufacturer's instructions.
- Make sure that the chain is always sharp and the lubrication reservoir is full.
- Start the saw on the ground or on another firm support. Drop starting is never allowed.
- Start the saw at least 10 feet from the fueling area, with the chain's brake engaged.

### Fueling a Chain Saw

- Use approved containers for transporting fuel to the saw.
- Dispense fuel at least 10 feet away from any sources of ignition when performing construction activities.  
**No smoking during fueling.**
- Use a funnel or a flexible hose when pouring fuel into the saw.
- Never attempt to fuel a running or HOT saw.

### Chain Saw Safety

- Clear away dirt, debris, small tree limbs and rocks from the saw's chain path. Look for nails, spikes or other metal in the tree before cutting.
- Shut off the saw or engage its chain brake when carrying the saw on rough or uneven terrain.
- Keep your hands on the saw's handles, and maintain secure footing while operating the saw.
- Proper personal protective equipment must be worn when operating the saw, which includes hand, foot, leg, eye, face, hearing and head protection.
- Do not wear loose-fitting clothing.
- Be careful that the trunk or tree limbs will not bind against the saw.
- Watch for branches under tension, they may spring out when cut.
- Gasoline-powered chain saws must be equipped with a protective device that minimizes chain saw kickback.
- Be cautious of saw kickback. To avoid kickback, do not saw with the tip. If equipped, keep tip guard in place.

# FOR SAFE OPERATION

**DO NOT** use this machine unless appropriately instructed in its safe use and operation permission to operate has been given.



## PRE-OPERATIONAL SAFETY CHECKS

1. DO NOT OPERATE THIS CHAINSAW UNLESS YOU HAVE READ THE OPERATOR MANUAL. USE THE CHAINSAW AS RECOMMENDED IN THE OPERATOR MANUAL AT ALL TIMES.
2. Ensure the machine is clean to help identify loose, worn or defective parts and other safety hazards.
3. Inspect fuel lines, tank, and area around carburetor for fuel leaks. Do not use the chainsaw if leaks are found.
4. Check the effectiveness of chain brakes and operating controls.
5. Ensure safety guards and other fitted safety features are secure and functioning.
6. Check condition of the anti-vibration mountings of the handles.
7. Ensure that the chain is sharp and correctly tensioned.
8. Faulty equipment must not be used. Report suspect machinery immediately.
9. DO NOT PROCEED if you have not been trained and Assessed as competent to use a chainsaw. You should be in good physical condition to operate the chainsaw.
10. DO NOT PROCEED to use a Chainsaw to Fell Trees.

## OPERATIONAL SAFETY CHECKS

1. Follow all safety precautions in the Manufacturer's Safety Manual - improper use can cause serious or fatal injury.
2. When starting the chainsaw:
3. Start the chainsaw resting on the ground:
  - a. Ensure no obstructions are present particularly near the tip of the guide bar.
  - b. Place the right foot through the rear handle and place the left hand on the front handle.
  - c. Operate the starter with the right hand.
  - d. Keep a firm grip on the chainsaw with both hands, with the thumb of the hand holding the front handle wrapped around the handle.
4. Maintain a proper balance and secure footing when operating the chainsaw.
5. Start the cut with the saw chain rotating at full speed and the spiked bumper in contact with the wood.
6. Be aware of the position of the guide-bar nose at all times when the saw chain is in motion.
7. Pay full attention to the operation and be alert for movement of the material being cut.
8. Be alert to situations that may cause material to pinch the top of the saw chain.
9. Apply chain brake when the saw is at rest.
10. Avoid the accumulation of debris and keep the chainsaw clean.
11. Never use a chainsaw over or above shoulder height.
12. Allow a hot chainsaw to cool before refilling the fuel tank.

## HOUSEKEEPING

1. Remove any foreign material from the motor and guards.
2. Clean entire chainsaw at completion of task.
3. Sharpen saw chain as per manufacturer's recommendation and as required.
4. Service motor as per manufacturer's recommendation.
5. Keep the work area and implement shed in a clean and tidy condition.

## POTENTIAL HAZARDS

1. Crush injury - Use recommended cutting techniques and stand away from fall zones when operating chainsaw.
2. Cuts and lacerations - Use chain lock when motor running and not cutting. Avoid moving chain and avoid kickback as per operator manual. Wear PPE (Chaps and Gloves) as recommended by the Manufacturer
3. Hearing injury - Use recommended PPE for noise reduction. Ensure chainsaw muffler is in good condition.
4. Flying debris - Use recommended PPE and move bystanders away from operation worksite.
5. Eye injury - Wear eye protection as recommended PPE at all times.
6. Loose clothing, entanglement - Remove jewelry and loose clothing. Wear recommended overalls or Protective Clothing including Chaps and Gloves.