

ITEM# GPBENCH-TL

200 LB MAX CAPACITY MULTI-USE GALVANIZED STEEL BENCH INSTRUCTION MANUAL



READ ALL INSTRUCTIONS AND WARNINGS BEFORE USING THIS PRODUCT.

This manual provides important information on proper operation & maintenance. Every effort has been made to ensure the accuracy of this manual. These instructions are not meant to cover every possible condition and situation that may occur. We reserve the right to change this product at any time without prior notice.

IF THERE IS ANY QUESTION ABOUT A CONDITION BEING SAFE OR UNSAFE, DO NOT OPERATE THIS PRODUCT!

CONTACT CUSTOMER SERVICE IF YOU HAVE ANY QUESTIONS.

If you experience a problem, have questions or need parts for this product, visit our website at <http://www.amerihomebrand.com>, or call Customer Service at 1-636-532-9888, Monday-Friday, 8 AM - 4 PM Central Time. A copy of the sales receipt is required.









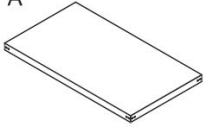
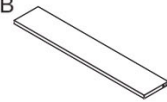

FOR CONSUMER USE ONLY – NOT FOR PROFESSIONAL USE.

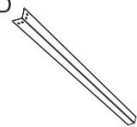
KEEP THIS MANUAL, SALES RECEIPT & APPLICABLE WARRANTY FOR FUTURE REFERENCE.

⚠ WARNING

- Do not climb, sit on, or use this product as a ladder. Injuries may occur.
- **DO NOT PLACE ANY OBJECT HEAVIER THAN 200 LB MAX CAPACITY.**
- Do not place or install electrical items on this product. Electrical shock may occur if wet conditions are introduced.

PARTS LIST

<p>A</p>  <p>Bench Top 1 pc</p>	<p>B</p>  <p>Shelf 1 pc</p>	<p>C</p>  <p>Back Legs 2 pcs</p>	<p>D</p>  <p>Front Legs 2 pcs</p>	<p>E</p>  <p>Corner Brackets 4 pcs</p>	
<p>F</p>  <p>Plastic Feet 4 pcs</p>	<p>G</p>  <p>Bolts 24 pcs</p>	<p>H</p>  <p>Nuts 24 pcs</p>	<p>I</p>  <p>Washer 24 pcs</p>	<p>J</p>  <p>Washer 24 pcs</p>	<p>K</p>  <p>Hex wrench 1 pc</p>

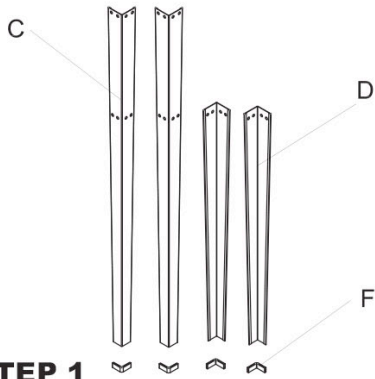

STEP 1

Slide the Plastic Feet (F) onto the ends of the legs (C & D).

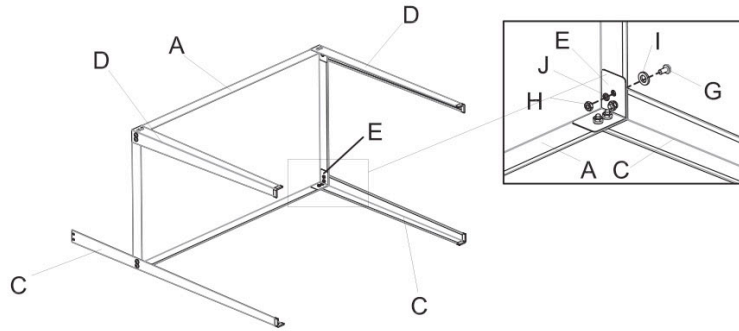

STEP 2

Line up the holes at the two corners of the bench top (long edge) with the holes in the middle part of two back legs (C). Connect them with Bolts (G) and Nuts (H). Please remember to put two kinds of washers between, Use Hex Wrench (K) to place two kinds of washers in between. Then connect the left two Front Legs (D) with the left two corners of the bench top. Attach four corner brackets (E) using Bolts (G), Nuts (H) and Washer (I & J).

STEP 3

Connect the shelf (B) horizontally front the two ends with Bolts (G), Nuts (H) and Washer (I & J) between. Washer (I) is for outside and (J) is for inside.

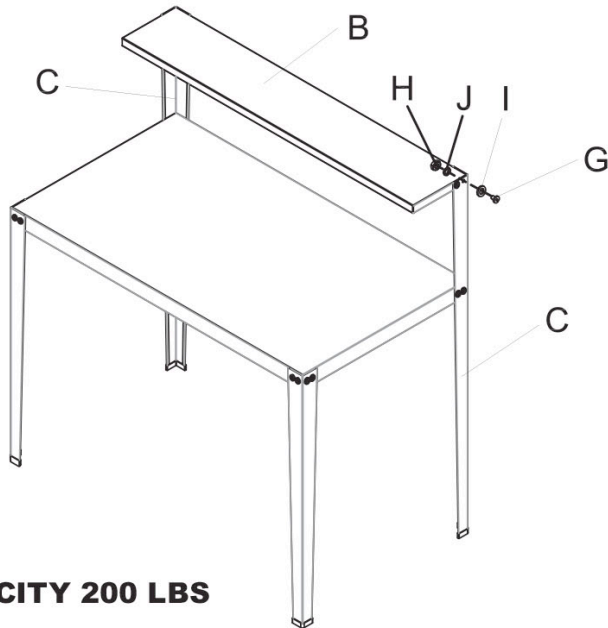

WARNING!

DO NOT EXCEED MAX WEIGHT CAPACITY 200 LBS