

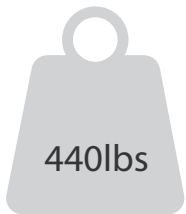

HANGOUT POD

Hangout Pod Stand

*Important - Please read and retain instructions to ensure safe use and



MAX!
440lbs

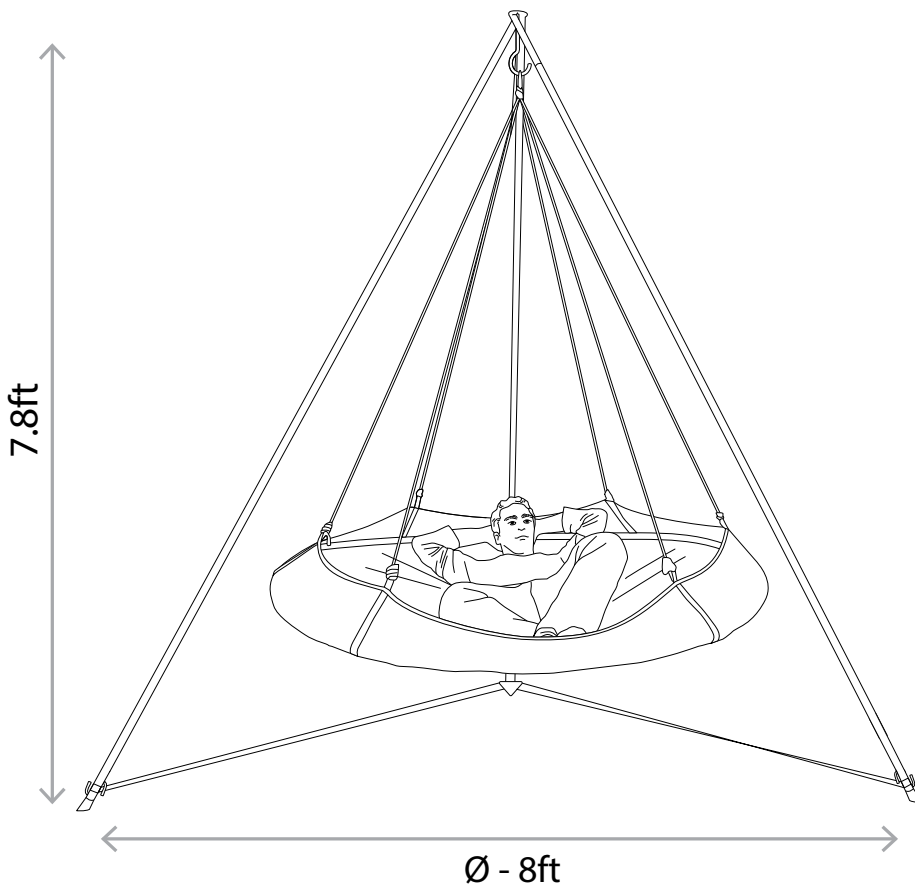
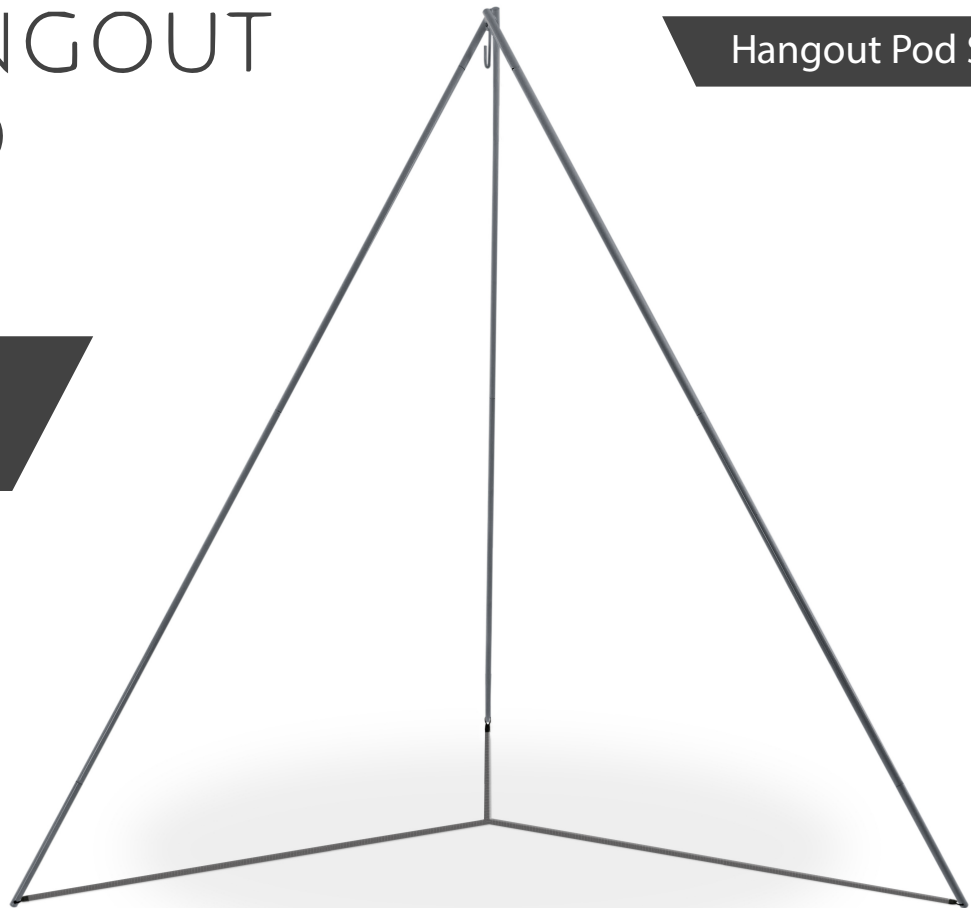

CONTENTS

1 x Peak Top Connector



3 x Top Poles

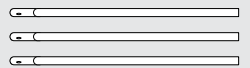

3 x Foot Poles

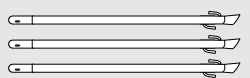

1 x Strap Base Connector

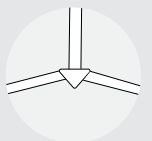

1 x Carry Bag



6x Nuts & Bolts
and 1x Allen Key

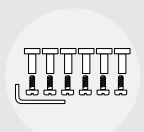

ASSEMBLY INSTRUCTIONS

- 1 Separate the 3 'Foot' poles (with feet) from the 3 'Top' poles (attaches to the 'Peak Top Connector').

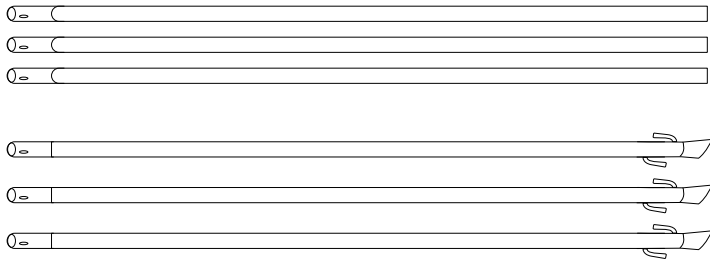

- 2 Attach the male end of the 'Foot Poles' to the female end of the 'Top Poles'.

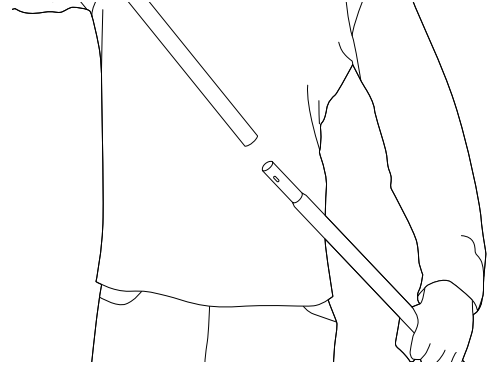

- 3 Repeat for all 3 sets of poles, ensuring all 3 connections are securely attached together.
***Important - Always use a nut and bolt on each pole to lock together.**

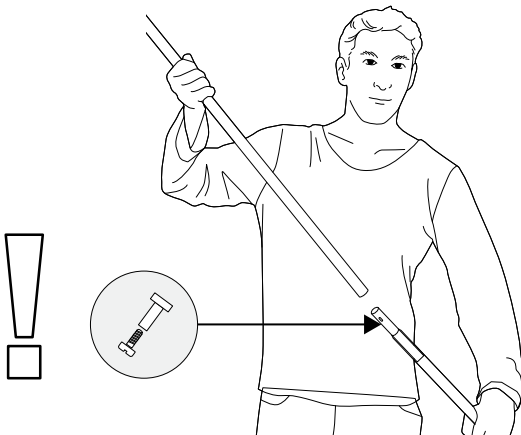

- 4 Attach the 'Peak Top Connector' to the male part of the 'Top Pole'.
***Important - Always use a nut and bolt on each pole to lock together.**

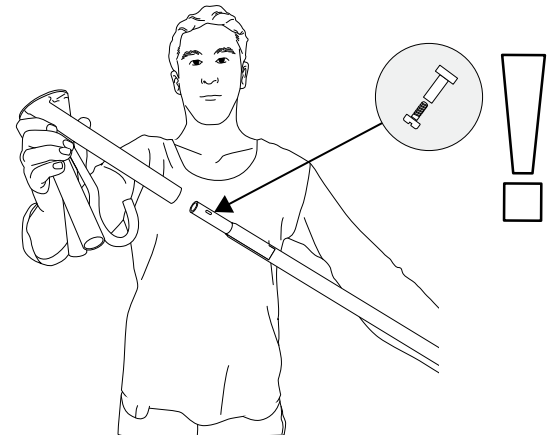

- 5 Repeat for all 3 'Top Poles' and erect upright to create a pyramid. Ensure all connections are attached and secure.

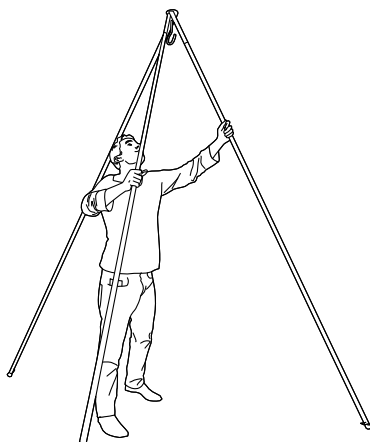

- 6 Lay the Strap Base Connector flat on the ground and feed the foot of each pole through the adjoining strap loop. Position the loop directly under the metal stopper.
***Important - Ensure the loops are hooked on to the poles, not the stoppers.**

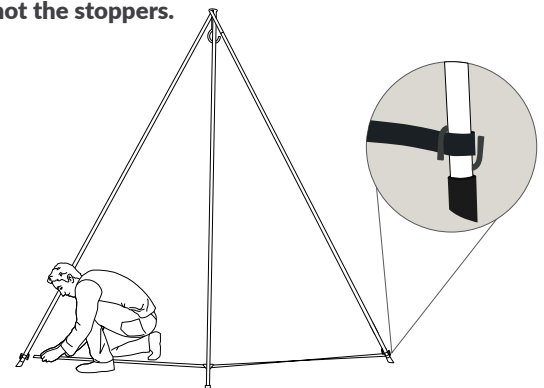

ASSEMBLY INSTRUCTIONS

7

Ensure poles are evenly spaced at 8ft apart, & connected to the base straps firmly.
*Warning - Straps should never slide above the metal stoppers or the Stand will become unsafe.

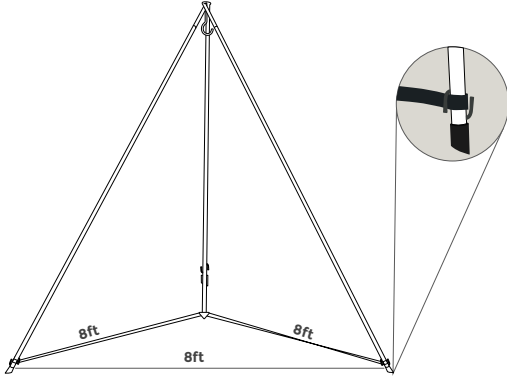

8

Attach the metal loop of the Hangout Pod to the hook on the underside of the 'Peak Top Connector'.

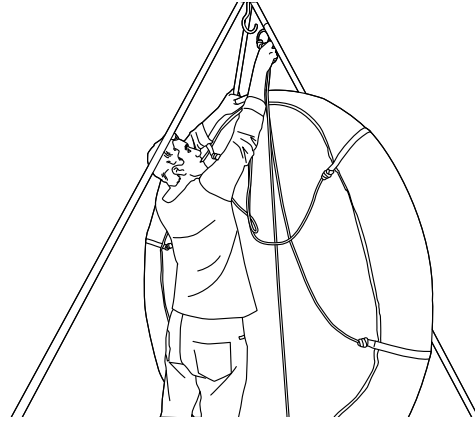

9

*Warning - Never use the Hangout Pod Stand without the Strap Base Connector securely connected to all of the 3 pole legs, check before each and every use.

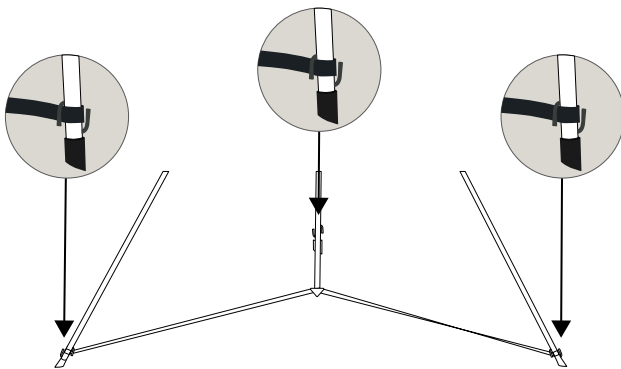

10

Check the Hangout Pod is hanging evenly within the center of the poles & is securely hooked onto the Stand with no twisted ropes or obstructions.

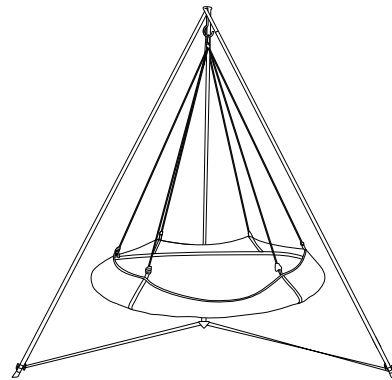

11

To enter, slowly sit bottom first facing away from the Pod. Hold onto the walls or ropes of the Pod for added balance & support.

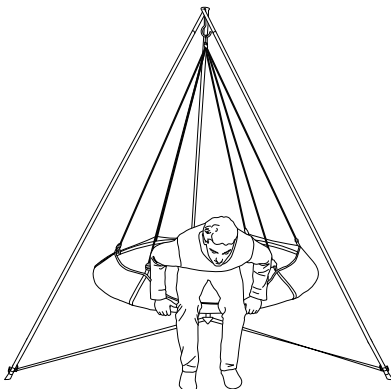

12

Gently shuffle yourself back into a comfortable position, centering yourself so the Pod falls naturally in the middle of the Stand.

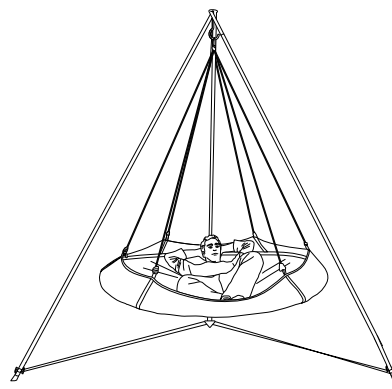

SAFETY INSTRUCTIONS

1

For use by children 4+ only, not for use by infants or young children.

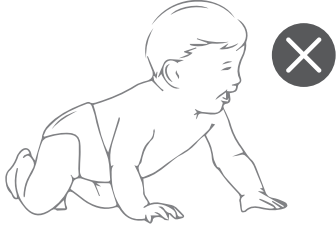

2

Never leave a child of any age unattended.

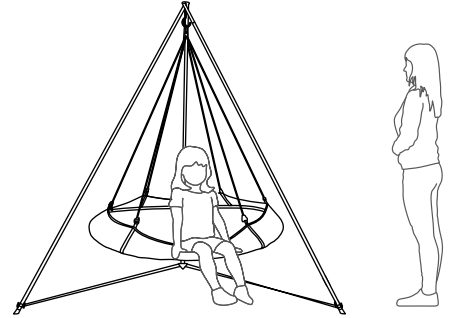

3

Never exceed maximum load limit of 440lbs.



4

Before each use, check that all connections are attached securely and inserted fully within one another.

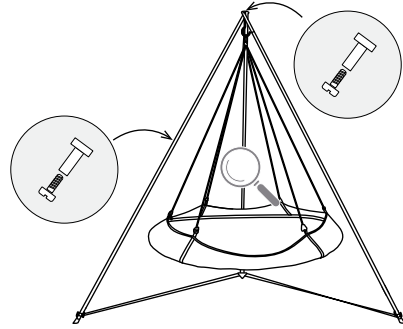

5

Never stand, swing or jump inside as this could cause injury.

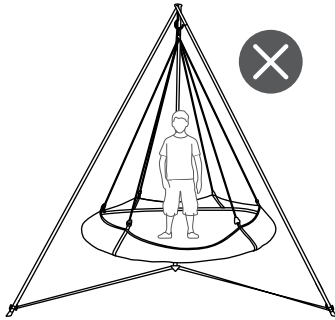

6

Smoking and naked flames of any type is forbidden.

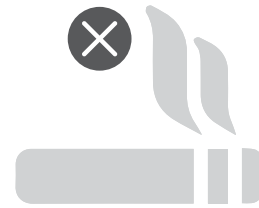

7

Double check that your desired spot is free from unwanted objects, sharp items, flames and obstructions of all kinds.

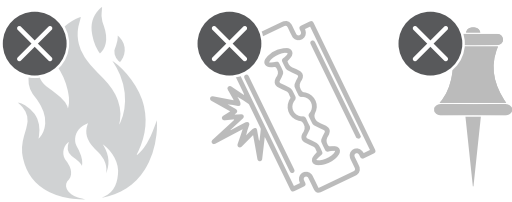

8

Always refer to the "Hangout Pod Safety & Care sections" prior to each use.

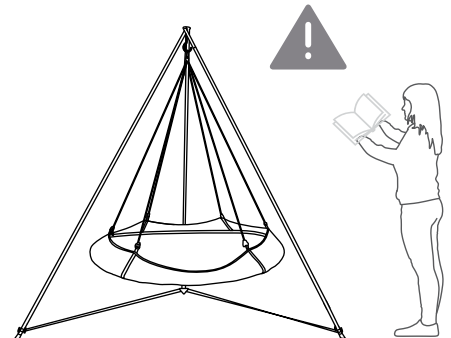

SAFETY INSTRUCTIONS

9

***Warning - Keep fingers and hands entirely clear of the ends of poles whilst connecting and disconnecting together to avoid injury.**

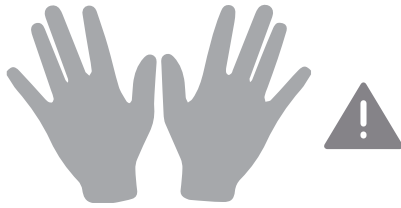

10

Never use a Stand on a sloping, uneven or soft ground as this can result in serious injury.

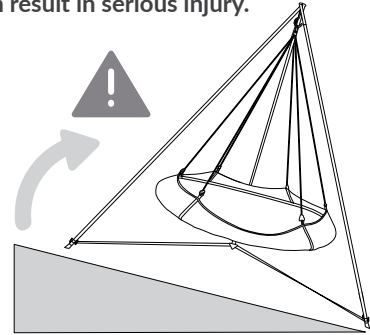

11

Never dive or climb in one foot at a time.



12

***Warning - Contains small parts! Choking hazard!**



13

Always ensure that the Stand is positioned on a dry, flat and horizontal surface.

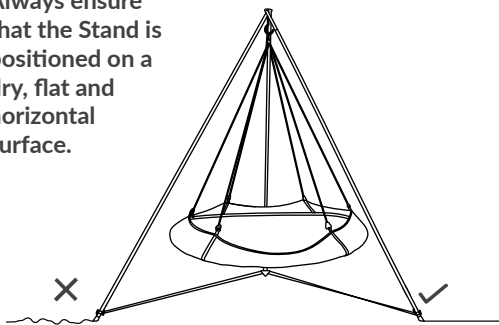

14

Never leave the Stand or any Hangout Pod product set up in undesired weather. Never use or leave out in storms or high winds. Pack away in advance of inclement weather. Failure to do so could result in serious damage or injury.



15

Never to be used as a climbing apparatus or toy.

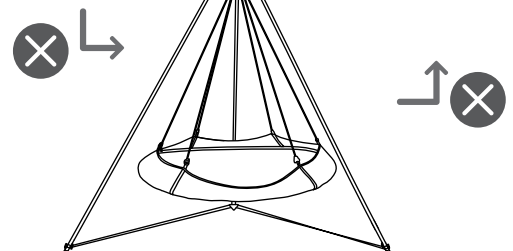
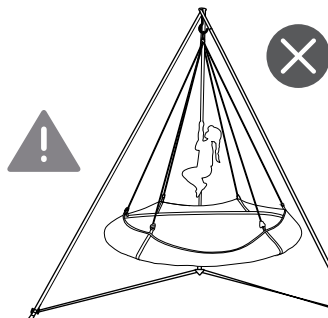

SAFETY INSTRUCTIONS

16

Do not use if the Stand has become damaged or if the metal has become compromised that would impair safe use.

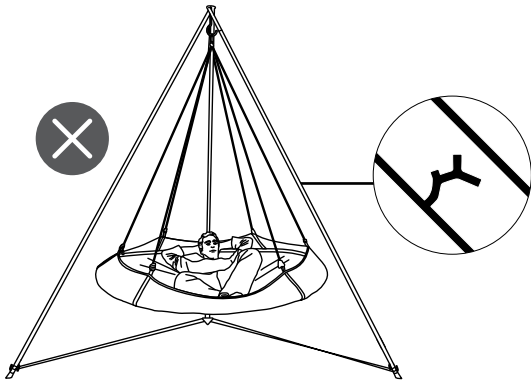

17

Refer to the 'Hangout Pod Safety' section in the Hangout Pod manual before using the Stand and Pod together.

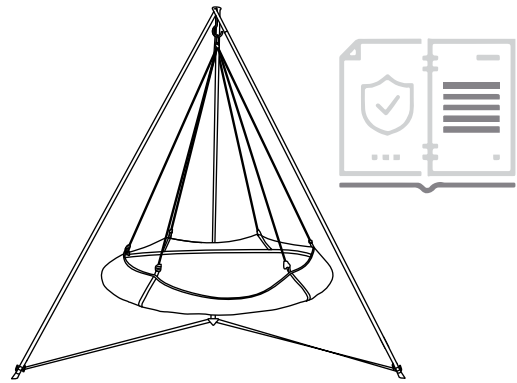

18

If the Hangout Stand is used with an alternative product other than the Hangout Pod, it is solely the responsibility of the user to ensure it is safe, appropriate and fitting to do so.

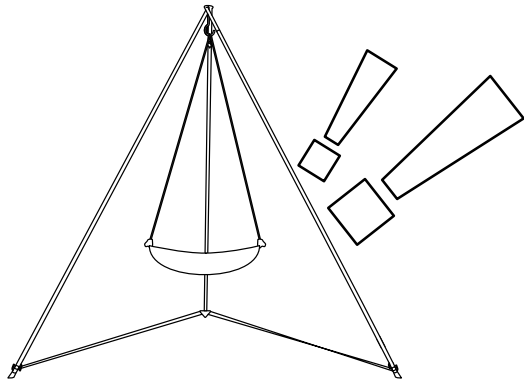

19

Children to be supervised at all times - never leave a child unattended. 4+ only.

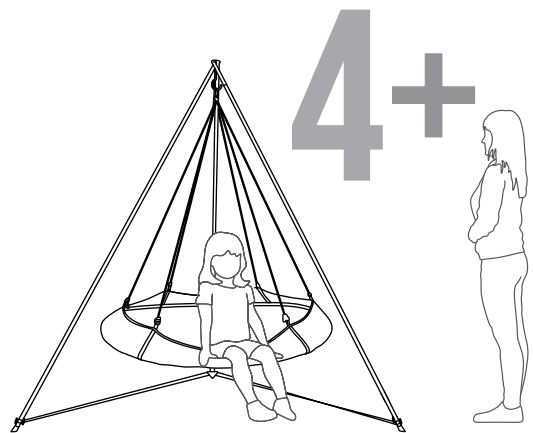

20

Tareo UK Ltd / Hangout Pod LLC & Tareo Pty Ltd take no responsibility for injury, loss or damage incurred if using this Stand for any other purpose not expressly intended by the manufacturer, or if used alongside other products outside of the Hangout Pod range.

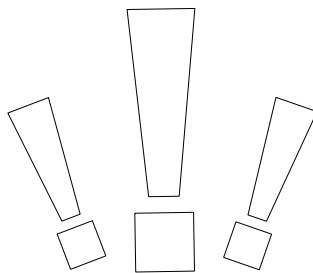

CARE & CLEANING

1

Not designed to be set up outdoors permanently. Store or pack away when not in use.

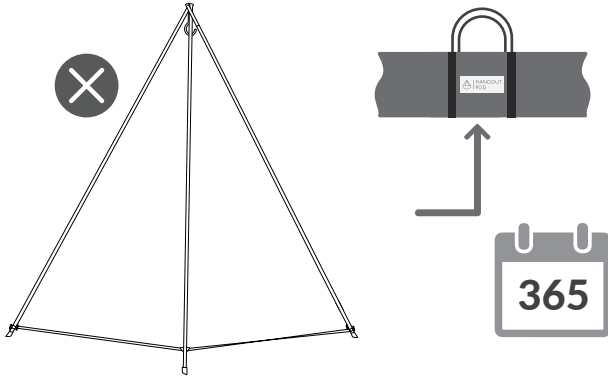

2

Recommended for use in fair weather only.

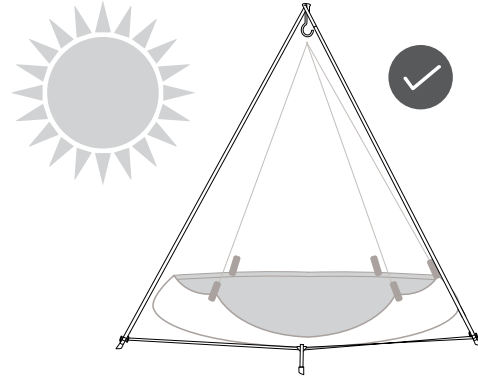

3

Failure to clean, dry and stow away will compromise lifespan & void warranty.

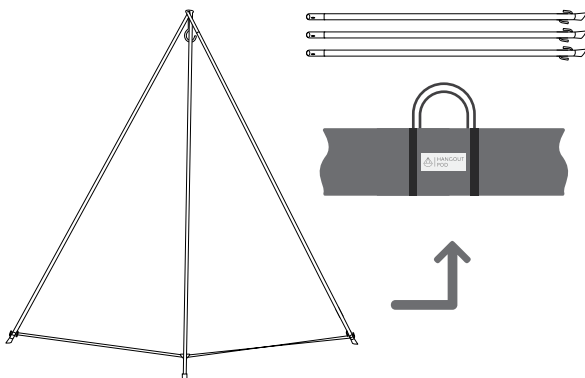

4

Always pack away in between uses **COMPLETELY DRY** to avoid rust and erosion.



5

To clean, simply wipe over with a slightly damp, soft cloth.

***Never use abrasive cleaning products, brushes or sponges as it will damage the powder coating.**



CARE & CLEANING

6

***Important - To avoid rust & erosion - Touch up and reseal any scratches, dints or damages to the powder coating immediately with an appropriate metal paint.**



7

Always dry the Stand when wet & limit exposure to water and rain; water can cause unseen rust from within the poles to stain the external surface.

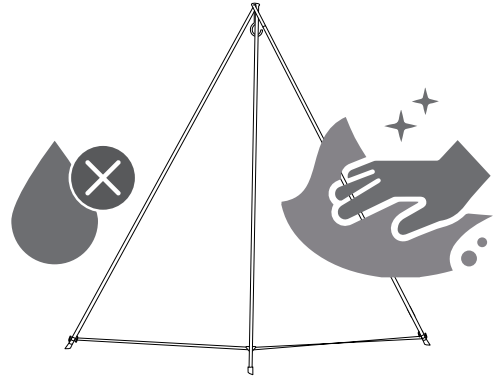

8

Do not allow the Stand to come into contact with another surface or object that could damage the strength of the Stand or the powder coating.

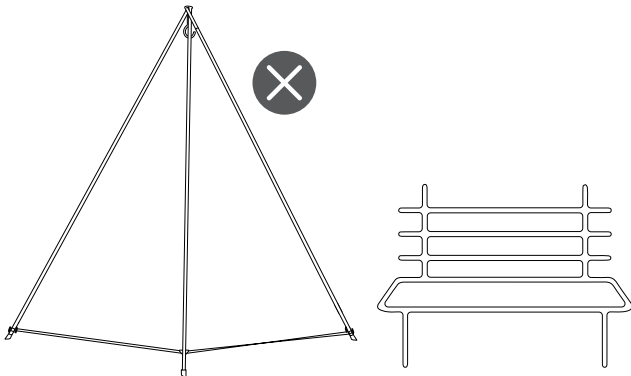

9

By following these simple care guidelines you will prolong the lifespan greatly of the Stand. Failure to do so will compromise the appearance and void the warranty.



10

A range of exciting Hangout Pod accessories are available for maximum enjoyment, minimal effort and ultimate fun:

www.hangoutpod.com



Please refer to website www.hangoutpod.com for regional warranty information. Proof of purchase always required. Warranty does not cover fair wear and tear or damage caused by lack of preventative maintenance. Warranty void if load limit is exceeded, if care instructions are not followed or if the Hangout Pod was not used or cared for appropriately. Please refer to the 'Safety' & 'Care & Cleaning' sections within this manual for details.

Not recommended for prolonged use outdoors. Always pack away between uses. Ensure all Hangout Pod products are packed away completely dry otherwise warranty will be voided. It is strongly recommended to use the Hangout Pod and Stand with the waterproof cover, sold separately. During periods of inclement weather of any kind, dry all elements and pack or stow away to avoid injury, damage, rust, wear and tear and voided warranty.

Warranty voided if used for commercial purposes.

Notwithstanding anything to the contrary contained in this document, Hangout Pod, herein Tareo UK LTD / Hangout Pod LLC / Tareo Pty Ltd, and all agents & representatives thereof will not, under any circumstances, be liable to distributor or end users for consequential, incidental, special, punitive, or exemplary damages or death arising out of or related to the use of any Hangout Pod products in a manner not expressly intended by the manufacturer.

The end user is responsible for ensuring the Hangout Pod is properly installed in accordance with this manual and for confirming the load bearing suitability of any hanging structure. Children to be supervised at all times – never leave a child unattended. Never place a child under the age of 4 years old within a Hangout Pod.

How to Contact Customer Support

Should you require customer service or technical support for any Hangout Pod product, please contact our Customer Service department at:

 hello@hangoutpod.com

 www.hangoutpod.com

Designed in the United Kingdom
Made in India

 **UK**
Tareo UK Ltd.
Wellington House, 90-92 Butt Road
Colchester
Essex, CO3 3DA
ENGLAND

 **USA**
Hangout Pod LLC
798 West Bartlett Road
Bartlett
Illinois, 60103
USA

 **AUS**
Tareo Pty Ltd.
Suite 485
Tugun
QLD, 4224
AUSTRALIA

Copyright Disclaimer

Any and all intellectual property rights in relation to Hangout Pod products or worldwide design rights are licensed exclusively to Tareo UK LTD / Hangout Pod LLC / Tareo Pty Ltd. All material, Hangout Pod designs and products, including text, video and images, contained within this document, email, website and/or promotional material are protected by worldwide design rights, copyright, brand and patent laws and is proprietary to Tareo UK LTD / Hangout Pod LLC / Tareo Pty Ltd (herein "Hangout Pod"). Disclosure, reproduction, translation or modification of any of the above material by anyone other than authorized employees, authorized users, or licensees of Hangout Pod without the prior written consent of Tareo UK LTD / Hangout Pod LLC / Tareo Pty Ltd is prohibited. The information in this document is subject to change without notice.

Disclaimer

Tareo UK LTD / Hangout Pod LLC / Tareo Pty Ltd & all agents & representatives thereof cannot assume responsibility for special, indirect, or consequential damages, contingent liability or death for use of this product in a manner not expressly intended by the manufacturer. The end consumer is ultimately responsible for verifying proper installation according to our guidelines herein. We strongly recommend that you always adhere to our hanging height recommendations and safety rules. These instructions can be downloaded from our website: www.hangoutpod.com