

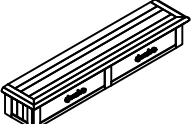

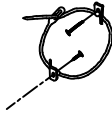

ASSEMBLY INSTRUCTIONS & PARTS IDENTIFICATION

CRESTVIEW # CVFVR8035

CONSOLE TABLE

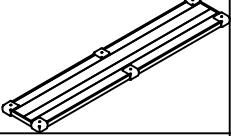
PARTS KEY.			HARDWARE LIST:				
No	Description	Qty	No	Description	Sketch	Size	Qty
A	 Table Top	1PC	1				2PC
B	 Table Leg	6PCS					
C	 Shelf	1PC					
D	 Foot Soles	6PCS					

STEP 1:

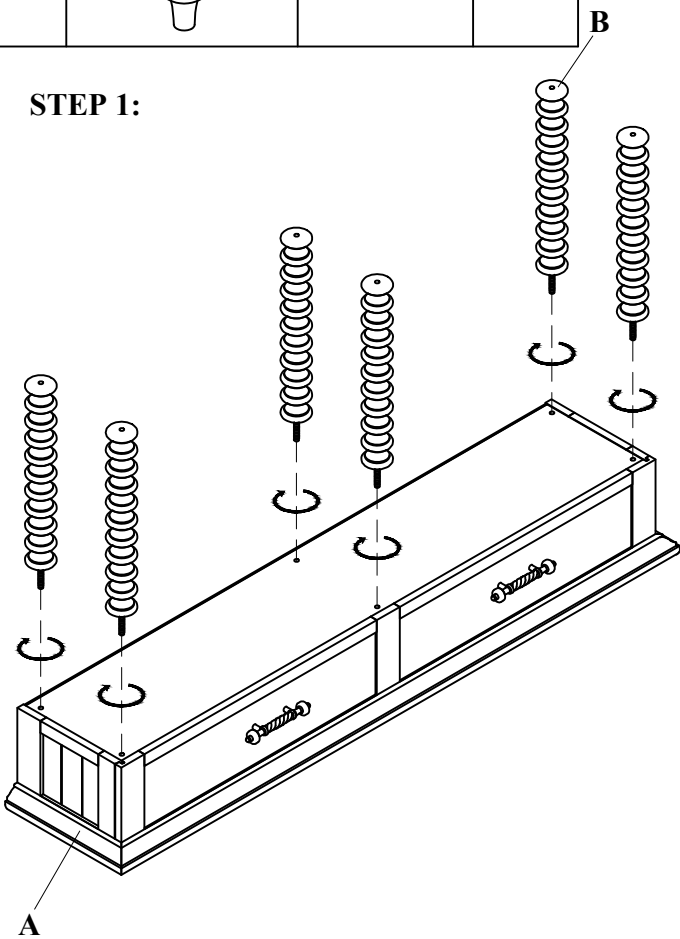

STEP 2:

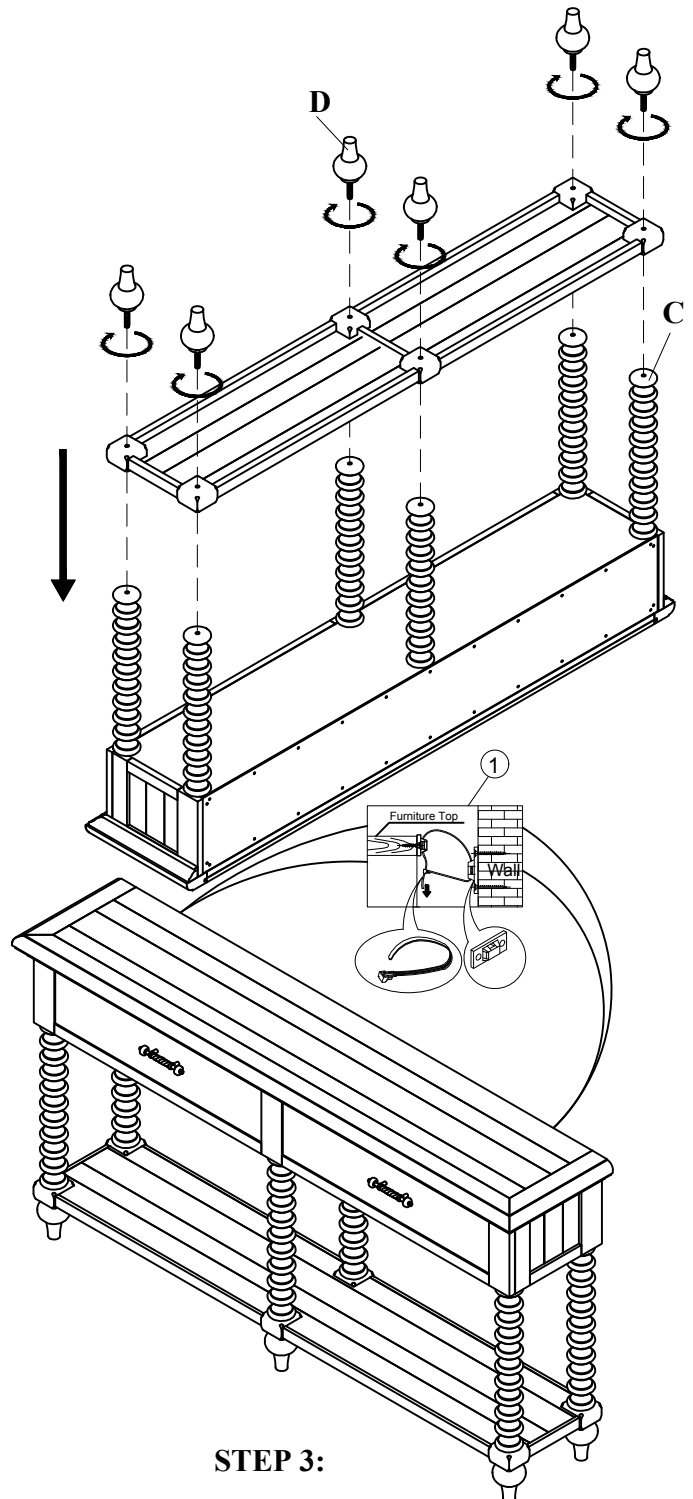

STEP 3: