

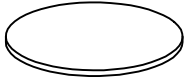

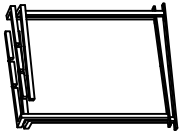



ASSEMBLY INSTRUCTIONS

CVFNR5085

PARTS

S.NO	DESCRIPTION	QNT
F	 TOP	1
G	 BASE	1

HARDWARE

S.NO	DESCRIPTION	QNT
A	 ALLEN SCREW BIG	5
B	 ALLEN SCREW SMALL	4
C	 WASHER	4
D	 ALLEN KEY 4MM	1
E	 ALLEN KEY 3MM	1

STEP 1

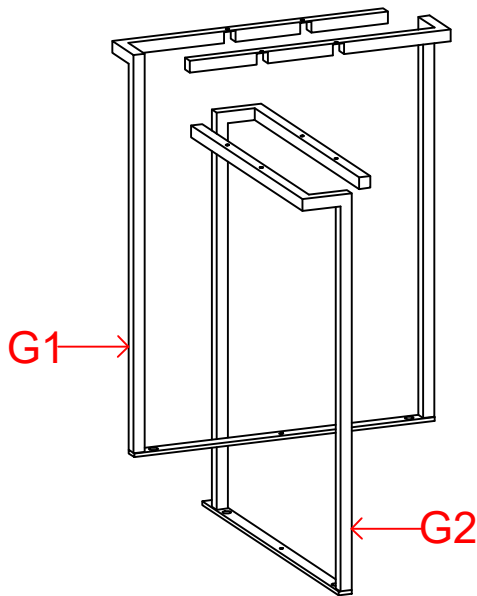

STEP 2

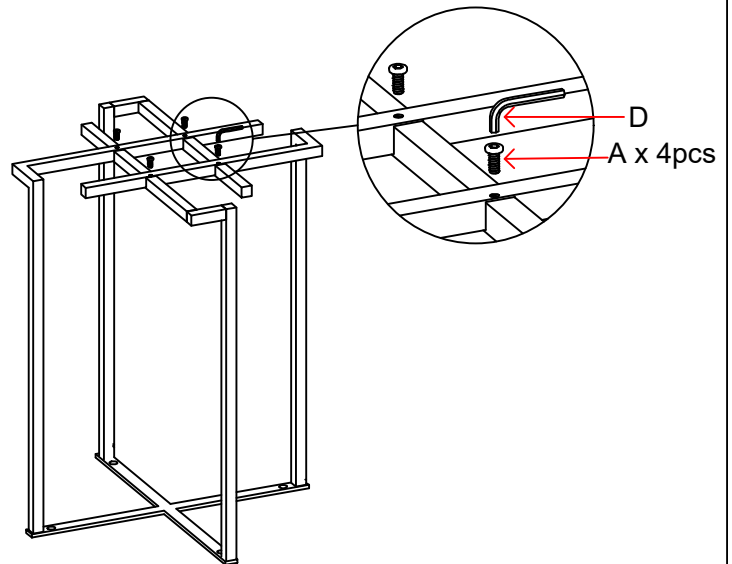

STEP 3

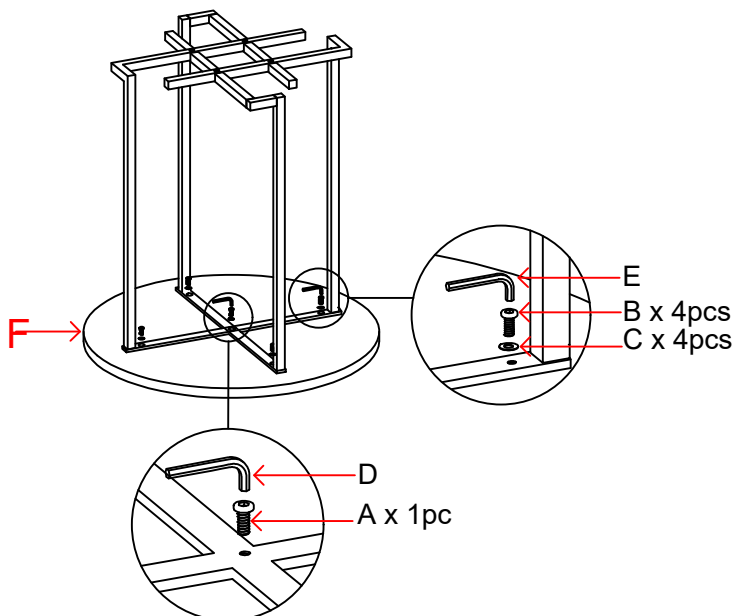

COMPLETED

