

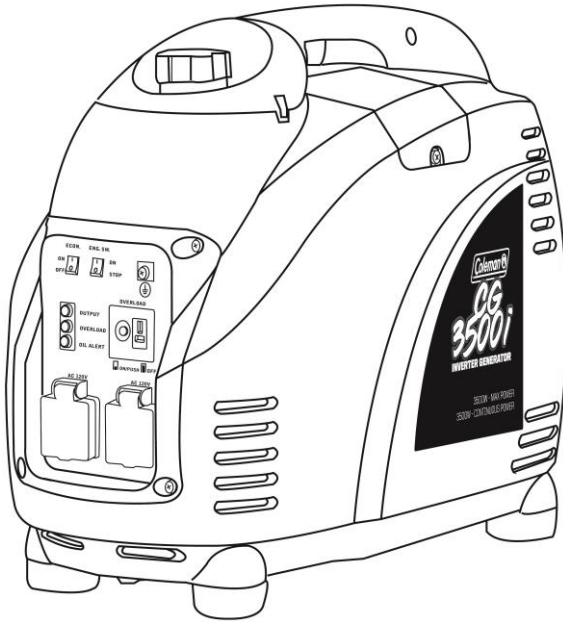

CG3500i Inverter generator

Owner's/User's Manual



IMPORTANT – Please make certain that persons who will be operating this generator thoroughly read and understand this user's manual prior to operation

(888)-405-8725 Coleman Powersports
PO Box 7909, Tempe, AZ. 85281
www.colemanpowered.com

INTRODUCTION

Congratulations on your purchase of a Coleman Inverter Generator. This Owner's/Operator manual will provide you information regarding safe operation, operational instructions, maintenance and care. Fully understanding this manual and following all of the instructions herein will provide the knowledge needed to have long and safe generator operation.

For questions regarding operation and maintenance of this generator, please call Coleman Powersports toll free 888-405-8725 or go to colemanpowered.com

TABLE OF CONTENTS

INTRODUCTION.....	1
COLEMAN LIMITED WARRANTY.....	3
SAFETY INFORMATION.....	5
CONTROL FUNCTIONS.....	6
DESCRIPTIONS.....	6
OIL WARNING SYSTEM.....	7
ENGINE SWITCH.....	7
ECONOMY CONTROL SWITCH.....	7
DC CIRCUIT BREAKER.....	7
FUEL VALVE.....	8
PRE OPERATION CHECK.....	8
ENGINE FUEL.....	8
ENGINE OIL.....	8
GROUND.....	9
STARTING THE ENGINE.....	9
USING ELECTRIC POWER.....	10
AC APPLICATION.....	10
DC APPLICATION.....	11
TURNING OFF ENGINE.....	12
PERIODIC MAINTENANCE.....	12
MAINTENANCE CHART.....	13
ENGINE OIL REPLACEMENT.....	14
AIR FILTER.....	14
CLEANING AND ADJUSTING SPARK PLUG.....	15
MUFFLER SCREEN.....	15
TROUBLE SHOOTING.....	16
STORAGE.....	17
SPECIFICATIONS.....	18
WIRE DIAGRAM.....	19

COLEMAN POWERSPORTS LIMITED WARRANTY

This Warranty is NOT the Emissions Control Warranty Please note this is a general Limited Warranty for this product. It IS NOT an Emissions Control Warranty. Please see the Emissions Control Warranty covering Emission components.

Coleman Powersports offers the following warranty to the initial purchaser of this new Coleman Powersports product. The initial purchaser is defined as the first person to purchase a new Coleman Powersports product from an Authorized Retailer of Coleman Powersports products.

The limited warranty period for this product is 1 year from the date of purchase shown on the original sales receipt.

What is a Defect? The Product is warranted to be free from manufacturing defects in material and workmanship for a period of 1 year from the date of purchase shown on the sales receipt. During this period of time Coleman Powersports will, at its option, either repair or replace any original Coleman Powersports part which is covered by this warranty and is proven to be defective in workmanship or material.

To qualify for this warranty the part:

1. Must have been purchased from Coleman Powersports or from an authorized Coleman Powersports Retailer.
2. This warranty does not apply to any product which is used in a manner not consistent with the normal and proper intended use. This generator is not intended for rental or commercial use.

Who Can Perform Repairs Under this Warranty?

Repairs under this warranty should be performed by an authorized Coleman Powersports retailer or comparable servicing dealer.

How to get service under this warranty

To get warranty service call Coleman Powersports at 888-405-8725 for the location of your local servicing retailer / dealer. Please do not return the product to the retailer where the product was purchased unless instructed to do so by Coleman Powersports. The retailer of this product does not make any warranty of its own and has no authority to implement this warranty on behalf of Coleman Powersports without the approval of Coleman Powersports. A COPY OF YOUR SALES RECEIPT IS REQUIRED FOR WARRANTY SERVICE.

What this Warranty Does Not Cover

This warranty does not cover the following

1. Damage due to lack or improper maintenance as described in this manual.
2. Damage which is caused by normal use and not caused by a defect in materials or workmanship.
3. Use of the product which is not consistent with the intended use as described in the operating instructions.
4. Any expendable maintenance item which need replacement or service as part of normal maintenance, unless such items have defects in material or workmanship which cause failure or premature wear.
5. Any product which has been altered or modified in a manner not consistent with the original design of the product or in a manner not approved by Coleman Powersports.
6. **Damage or failures due to abuse, neglect, or misuse of the product.**

Limitations of this Warranty

This warranty does not cover and Coleman Powersports disclaims any responsibility for

1. Loss of time or loss of use of the product.
2. Transportation costs to and from the authorized service center.
3. Other loss or damage to other equipment or personal items.

Length of Implied Warranties

Any implied warranties are limited to the duration set forth in this warranty. Coleman Powersports does not make any claim as to the merchantability or fitness for a particular purpose which would extend longer than the duration of this written warranty.

Check your State Laws as some State Laws do not allow limitations as to the duration of an implied warranty. Some States may also not allow limitation or exclusions based on incidental or consequential damages.

! WARNING

PLEASE READ AND UNDERSTAND THIS MANUAL COMPLETELY BEFORE OPERATING THE GENERATOR

SAFETY INFORMATION

1) EXHAUST FUMES ARE POISONOUS

- Never operate the engine in a closed area or it may cause unconsciousness and death within a short time. Operate the engine in a well ventilated area.

2) FUEL IS HIGHLY FLAMMABLE AND POISONOUS

- Always turn off the engine when refueling
- Never refuel while smoking or in the vicinity of an open flame.
- Take care not to spill any fuel on the engine or muffler when refueling.
- If you swallow any fuel, inhale fuel vapor, or allow any to get in your eyes, see your doctor immediately. If any fuel spills on your skin or clothing, immediately wash with soap and water and change your clothes.
- When operating or transporting the generator, be sure it is kept upright. If it tilts, fuel may leak from the carburetor or fuel tank.

3) ENGINE AND MUFFLER MAY BE HOT

- Place the generator in a place where pedestrians or children are not likely to touch it.
- Avoid placing any flammable materials near the exhaust outlet during operation.
- Keep the generator at least 1 m (3 ft) from buildings or other equipment, or the engine may overheat.
- Avoid operating the engine with a dust cover.
- Be sure to carry the generator only by its carrying handle.
- Place the generator on flat surfaces and keep clear of debris, this will allow heat to dissipate freely.

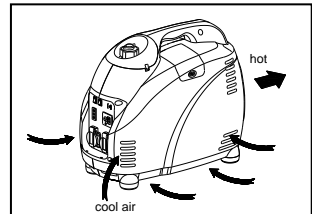

4) ELECTRIC SHOCK PREVENTION

- Never operate the engine in rain or snow.
- Never touch the generator with wet hands or electrical shock will occur.
- Be sure to ground (earth) the generator.

NOTE:

Use ground (earth) lead of sufficient current capacity.

Diameter: 0.12mm (0.005 in)/ampere

EX: 10 Ampere –1.2mm (0.055 in)

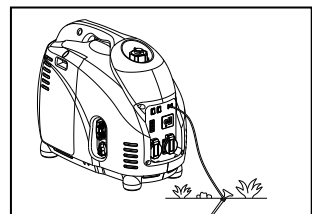

5) CONNECTION NOTES

- Avoid connecting the generator to any commercial power outlet.
- Avoid connecting the generator in parallel with any other generator.

CONTROL FUNCTIONS

DESCRIPTIONS

- | | | |
|----------------------------|------------------------------|------------------------------|
| (1) Economy control switch | (2) Engine switch | (3) Fuel tank |
| (4) Spark plug | (5) Muffler | (6) Carrying handle |
| (7) Choke lever | (8) AC pilot light | (9) Overload indicator light |
| (10) Oil warning light | (11) DC protector | (12) DC receptacle |
| (13) AC receptacle | (14) Ground (earth) terminal | (15) Fuel filter |
| (16) Fuel tank cap | (17) Recoil starter | (18) Fuel valve |
| (19) Oil filler cap | (20) Air filter cover | |

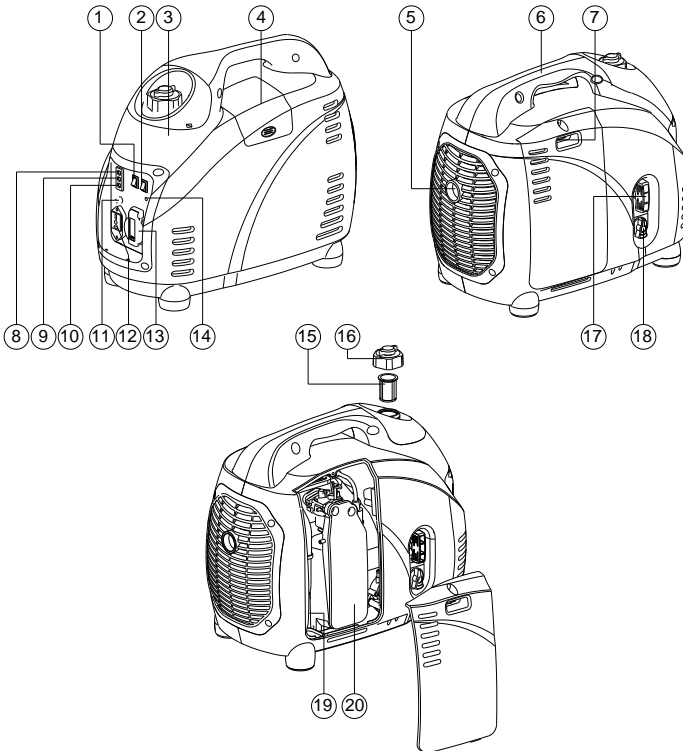

1) OIL WARNING SYSTEM

When the oil level falls below the lower level, the engine stops automatically. Unless you refill with oil, the engine will not start again.

2) ENGINE SWITCH

The engine switch controls the ignition system.

① "ON"(run)

Ignition circuit is switched on. The engine can be started.

② "OFF"(stop)

Ignition circuit is switched off. The engine will not run.

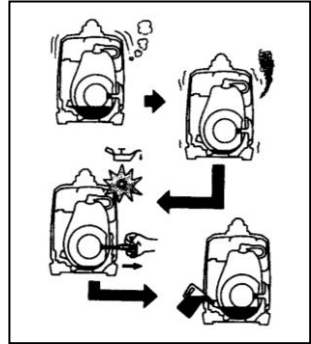

3) ECONOMY CONTROL SWITCH

When the economy control switch is turned "ON", the economy control unit will control the engine speed according to the connected load. The results are better fuel economy and less noise.

4) DC CIRCUIT PROTECTOR

The DC circuit protector turns off automatically when the load exceeds the generator rated output.

CAUTION:

- Reduce the load to within specified generator rated output if the DC circuit protector turn off.

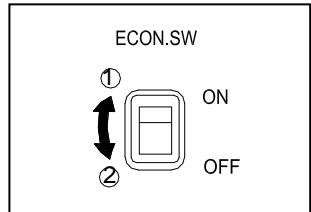
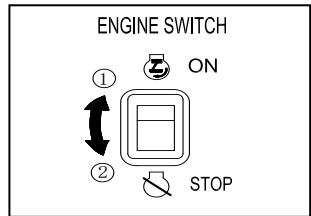

5) FUEL VALVE

The fuel valve is used to supply fuel from the tank to the carburetor.

PRE OPERATION CHECK

NOTE:

- Add at least .5 gallons (2 liters) before attempting to start the engine the first time.
- Pre-operation checks should be made each time the generator is used.

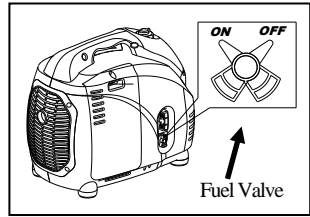

1) CHECK ENGINE FUEL

- Make sure there is sufficient fuel in the tank.
- If fuel is low, refill with unleaded gasoline.
- Be sure to use the fuel filter screen on the fuel filter neck.
- Recommended fuel: Unleaded gasoline.
- Fuel tank capacity: **(see page 15,16)**

WARNING:

- Do not refill tank while engine is running or hot.
- Close fuel valve before refueling with fuel.
- Be careful not to admit dust, dirt, water or other foreign objects into fuel.
- Do not fill above the top of the fuel filter or it may overflow when the fuel heats up later and expands.
- Wipe off spilt fuel thoroughly before starting engine.
- Keep open flames away.

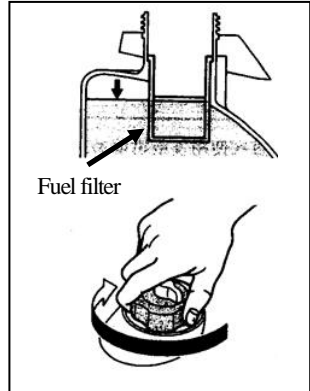

2) CHECK ENGINE OIL

Make sure the engine oil is at the upper level of the oil filler hole. Add oil as necessary.

- Remove oil filler cap and check the engine oil level.
- If oil level is below the lower level line, refill with suitable oil to upper level line. Do not screw in the oil filler cap when checking oil level.

- Change oil if contaminated.

1. Oil capacity: **(see page 15,16)**

- Recommended engine oil:

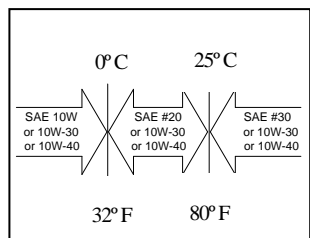
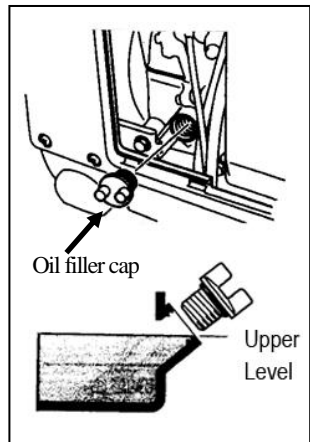

API Service "SJ"

3) GROUND (Earth)

Make sure to ground (earth) the generator.

OPERATION

NOTE:

- The generator has been shipped without engine oil. Please note that engine will not start without oil
- Do not tilt the generator when adding engine oil. This could result in overfilling and damage to the engine

1) STARTING THE ENGINE

NOTE:

- Before starting the engine, do not connect the electric apparatus.
 - Turn the economy control switch to the "OFF" position.
-
1. Turn the fuel valve lever to the "ON" position.
 2. Turn the engine switch to the "ON" position
 3. Turn the choke lever to the " | I " position. Not necessary if the engine is warm.
 4. Pull the starter handle slowly until resistance is felt. This is the "Compression" point. Return the handle to its original position and pull swiftly. Do not fully pull out the rope. After starting, allow the starter handle to return to its original position while still holding the handle. Grasp the carrying handle firmly to prevent the generator from falling over when pulling the recoil starter.
 5. Warm up the engine.
 6. Turn the choke lever back to the operating position.
 7. Warm up the engine without a load for a few minutes.

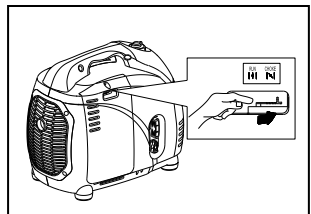
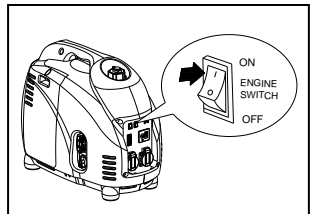
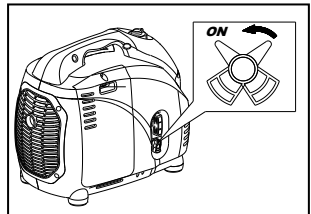
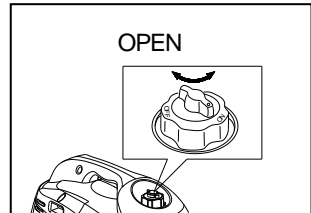
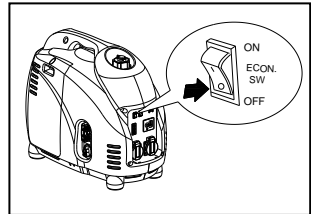
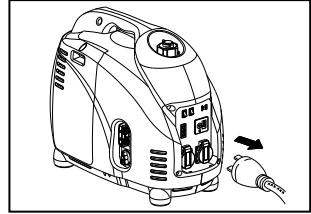

USING ELECTRIC POWER

1. AC APPLICATION

- (a) Check the AC pilot lamp for proper voltage.
- (b) Turn the economy control switch to the "ON" position.
- (c) Turn off the switch(es) of the electrical appliance(s) before connecting to the generator.
- (d) Insert the plug(s) of the electrical appliance(s) into the receptacle.

CAUTION: _____

- Be sure the electric apparatus is turned off before plugging in.
- Be sure the total load is within generator rated output.
- Be sure the socket load current is within socket rated current.
- The economy control switch must be turned to "OFF" when using electric devices that require a large starting current, such as a compressor or a submergible pump.

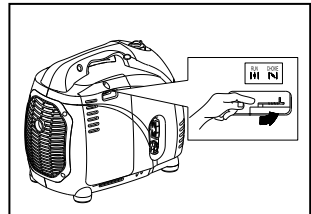
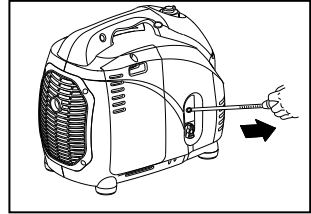

2. OVERLOAD INDICATOR LIGHT

The overload indicator light comes on when an overload of a connected electrical device is detected, the inverter unit overheats, or the AC output voltage rises. The electronic breaker will then activate, stopping power to the generation in order to protect the generator and any connected electric devices.

The output pilot light (green) will flicker and the overload indicator light (red) will turn on, then the engine will stop running. Once engine stalls the following steps should be taken:

- (a) Turn off any connected electric devices and stop the engine
- (b) Reduce the total wattage of connected electric devices within the application range.
- (c) Check for blockages in the cooling air inlet and around the control unit. If any blockages are found, remove.
- (d) After checking, restart the engine.

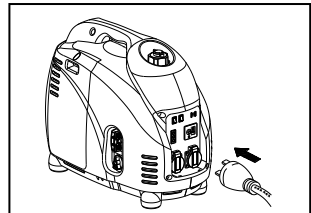
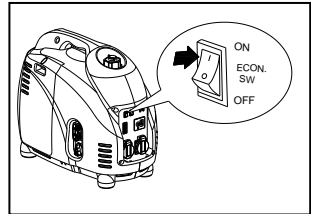

CAUTION: _____

- The generator AC output automatically resets when the engine is stopped and then restarted.
- The overload indicator light may come on for a few seconds at first when using electric devices that require a large starting current, such as a compressor or a submergible pump. However, this is not a malfunction.

3. DC APPLICATION (option)

This usage is applicable to 12V battery charging only.

(a) Charging instruction for battery

- Disconnect the leads for the battery.
- Loosen battery fluid caps if battery is not sealed.
- Fill distilled water to the upper limit, if the battery fluid is low level.
- Measure the specific gravity for the battery fluid by using the hydrometer, and calculate the charging time in according with the table shown on right side.
- The specific gravity for the fully charged battery shall be within 1.26 to 1.28. It is recommended to confirm every an hour.

(b) Connect between the DC output socket and the battery terminals using the charging leads. The leads shall be connected making sure of the (+) and (-) polarity.

(c) The DC circuit protector is to be set to "ON" after confirming the connection, if the protector is in "OFF" position.

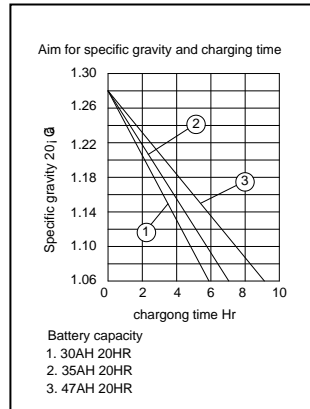

CAUTION:

- Be sure the economy control switch is turned off while charging a battery.

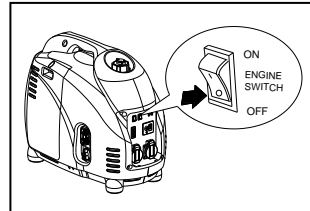
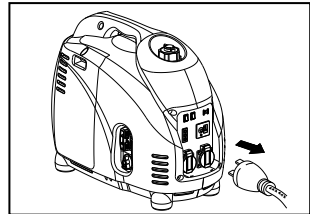

3) STOPPING THE ENGINE

1. Turn off the power switch of the electric apparatus or disconnect any electric devices.
2. Turn the engine switch to "OFF" position.
3. Turn the fuel lever to "OFF".

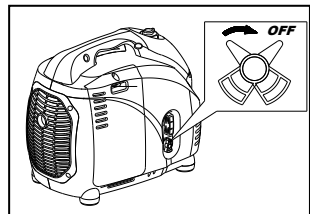

PERIODIC MAINTENANCE

1) MAINTENANCE CHART

Regular maintenance is most important for the best performance and safe operation.

Item	Remarks	Pre-operation check (daily)	Initial 1 months or 20 Hr	Every 3 months or 50Hr	Every 6 months or 100Hr	Every 12 months or 300Hr
Spark Plug	Check condition adjust gap and clean. Replace if necessary.			●		
Engine Oil	Check oil level	●				
	Replace		●		●	
Oil filter	Clean oil filter				●	
Air Filter	Clean. Replace if necessary.			●		
Fuel Filter	Clean fuel cock filter. Replace if necessary				●	
Choke	Check choke operation	●				
Valve Clearance	Check and adjust when engine is cold.					●
Fuel Line	Check fuel hose for crack or damage. Replace if necessary.	●				
Exhaust System	Check for leakage. Retighten or replace gasket if necessary	●				
	Check muffler screen. Clean / replace if necessary.					●
Carburetor	Check choke operation	●				
Cooling system	Check fan damage.					●
Starting system	Check recoil starter operation.	●				
Idle speed	Check and adjust engine idle speed					●
Fittings / Fasteners	Check all fittings and fasteners correct if necessary.				●	
Crankcase breather	Check breather hose for cracks or damage. Replace if necessary					●
Generator	Check the pilot light comes on	●				

2) ENGINE OIL REPLACEMENT

1. Place the generator on a level surface and warm up the engine for several minutes. Then stop the engine and turn the fuel lever to "OFF".
 2. Loosen the screw and remove the outer cover.
 3. Remove the oil cap
 4. Place an oil pan under the engine. Tilt the generator to drain the oil completely
 5. Once oil has completely drained place the generator on a level surface.
 6. Add engine oil to the upper level.
 7. Install the oil filler cap
 8. Install the cover and tighten the screw
- Recommended engine oil: (**see page 15,16**)

API Service "SJ"

CAUTION:

- Be sure no foreign material enters the crankcase.
- Do not tilt the generator when adding engine oil. This could result in overfilling and damage to the engine
- Clean the oil filter every other 100hr.

3) AIR FILTER

Keeping the air filter clean is very important. Dirt induced through improperly installed, improperly serviced, or inadequate elements will damage and wear out the engine. Always keep the air filter element clean.

1. Remove the cover.
2. Remove the air filter cover and element.
3. Wash the element in solvent and dry.
4. Oil the element with air filter oil and squeeze out excess. The element should be wet but not dripping.
5. Insert the element into the air filter housing.
6. Install the cover.

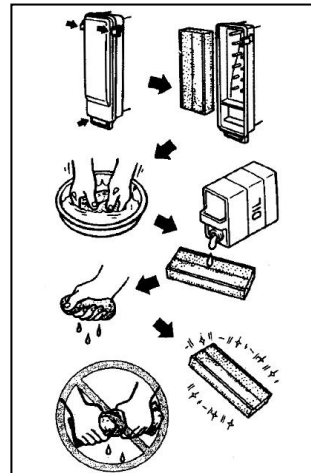
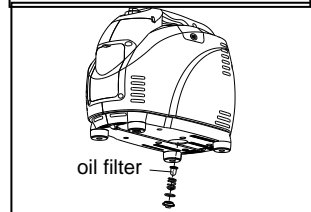
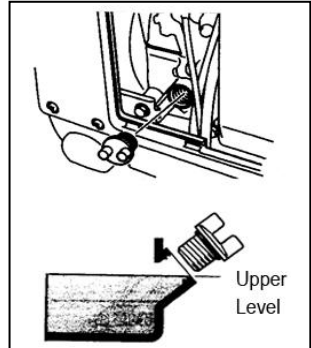
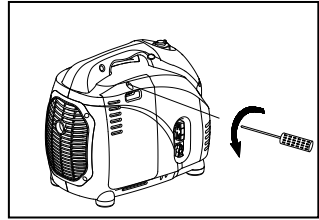

CAUTION: _____

The engine should never run without the air filter element; excessive piston and/or cylinder wear may result.

4) CLEANING AND ADJUSTING SPARK PLUG

1. Remove spark plug cover and plug
2. Check for discoloration on the electrode and remove any carbon build up.
3. Check spark plug type and gap.
4. Install the spark plug.
5. Install the cover

Standard electrode color: Tan Color
Standard Spark Plug: CR4HSB (NGK)
Spark Plug Gap: 0.6-0.7 mm (0.024-0.028 in)

5) FUEL TANK FILTER

1. Remove the fuel tank cap and filter.
2. Clean the filter with solvent. If damaged, replace.
3. Once filter is clean, re-install it.

! WARNING _____

- Be sure the tank cap is tightened securely.
-

6) MUFFLER SCREEN

! WARNING _____

- The engine and muffler will be very hot after the engine has been run.
 - Avoid touching the engine and muffler while they are still hot with any part of your body or clothing during inspection or repair.
-

1. Remove the cover.
2. Remove the muffler screen.
3. Use a flathead screw driver to pry the spark arrester out from the muffler

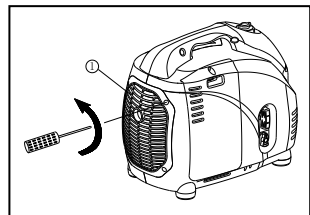
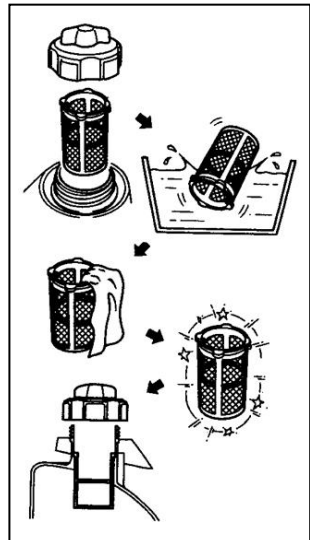
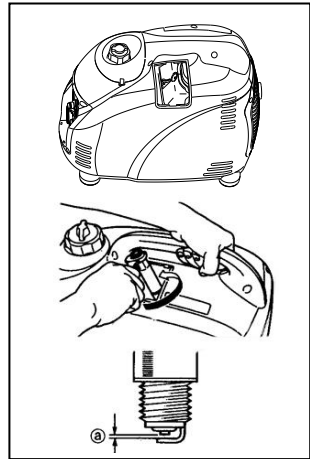

4. Remove the carbon deposits on the muffler screen and spark arrester using a wire brush.
5. Install the muffler screen.
6. Install the cover

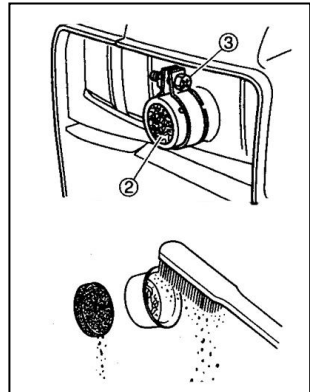

TROUBLESHOOTING

1) Engine won't start

1. Fuel systems

No fuel supplied to combustion chamber.

- No fuel in tank...Supply fuel.
- Clogged fuel line...Clean fuel line.
- Clogged carburetor...Clean carburetor.

2. Engine oil

- Oil level is low...Add engine oil.

3. Electrical system

Poor spark

- Spark plug dirty with carbon or wet...Remove carbon or wipe spark plug dry.
- Faulty ignition system...Consult dealer.

4. Compression insufficient

- Worn out piston and cylinder...Consult dealer.

2) Generator won't produce power

Safety device (AC) to "OFF" ...Stop the engine, then restart.

Safety device (DC) to "OFF" ...Press to reset the DC protector

STORAGE

Long term storage of your generator will require some preventive procedures to guard against deterioration.

1) DRAIN THE FUEL

1. Remove the fuel tank cap, drain the fuel from the fuel tank
2. Remove the cover, drain fuel from the carburetor by loosening the drain screw.

2) ENGINE

2. Remove the spark plug, pour in about one tablespoon of SAE 10W30 or 20W40 motor oil into the spark plug hole and reinstall the spark plug.
3. Use the recoil starter to turn the engine over several times (with ignition off).
4. pull the recoil starter until you feel compression.
5. Stop pulling.
6. Clean exterior of the generator and apply a rust inhibitor.
7. Store the generator in a dry, well-ventilated place, with a cover place over it.
8. The generator must remain in a vertical position.

SPECIFICATIONS

MODEL		CG3500i		
GENERATOR	Type	Inverter Generator		
	AC Voltage	50Hz	100, 230V, 240V	
		60Hz	100, 120V, 240V	
	Max. Output	2.0 kW	2.5 kW	3.5 kW
	Rated Output	1.8 kW	2.2 kW	3.0 kW
	Power Factor	1.0		
	DC Output	12V / 8.3A		
ENGINE	Model	XY157F		
	Type	Air-cooled, 4 cycle, OHC, Gasoline Engine		
	Bore × Stroke mm × mm	52.4 × 57.8	52.4 × 57.8	57.4 × 57.8
	Displacement	124.6cc	124.6cc	149.5cc
	Max. Output	3.5KW / 5500rpm	3.5KW / 5500rpm	4.0KW / 5500rpm
	Fuel	Regular Automobile Gasoline		
	Fuel tank Capacity	5.7 liters		
	Rated Continuous Operation	4h30min (100% Load) 5h50min (50% Load)	4h10min (100% Load) 5h30min (50% Load)	3h5min (100% Load) 4h10min (50% Load)
	Lubricating oil	SAE 10W30		
	Lubricating oil Capacity	0.9 liter		
	Starting System	Recoil Starter		
	Ignition system	C.D.I.		
	Spark Plug: Type	A7RTC		
DIMENSION	Net dimension L × W × H	565 × 320 × 470		
	Overall dimension L × W × H	595 × 355 × 510		
	Net Weight	29 Kg		
	Dry Weight	32Kg		

- Specifications subject to change without prior notice.

WIRE DIAGRAM

CG3500i

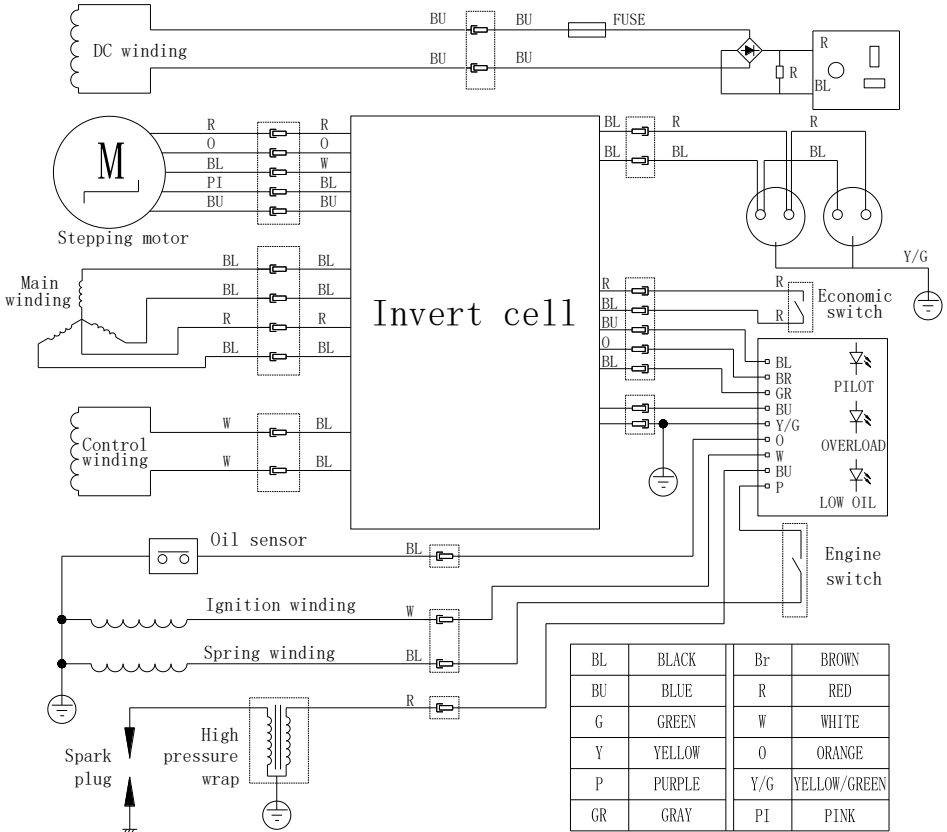

(888)-405-8725 Coleman Powersports
PO Box 7909, Tempe, AZ. 85281
www.colemanpowered.com