



MACRAME HAMMOCK CHAIR

Read the assembly instructions carefully and follow the care instructions.
Save these instructions for future reference.



Ensure all parts are accounted for before disposing of packaging.

PARTS	QTY.
Hammock Chair	1
Pillow	1
Chain	1
Carabiner	3
Round Eye Pad	1
Lag Screw	4
Expansion Bolt	4

⚠ CAUTION ⚠

This hammock chair is not designed for use as a swing. Bouncing, swinging, or any other significant movements while in the chair may result in serious injury or death.

Consulting a professional for ceiling-mount installation is highly recommended.

Weight Limit: 250 lbs.

⚠ WARNING!

Manufacturer and seller expressly disclaim any and all liability from personal injury, property damage or loss, whether direct or indirect, or incidental, resulting from the incorrect attachment, improper use, inadequate maintenance, or neglect of this product.

INSTALLATION (OPTIONAL)

Professional installation is recommended.

The intended installation area must be checked for suitability and strength.

! IMPORTANT INFORMATION & HELPFUL HINTS !

- The included expansion bolts are for concrete/brick and the lag screws are for wood.
- Do not install the plate too close to the edge of a beam where the edge could be at risk of splitting.
- Measure and confirm mounting hardware size before installation.
Lag Screws: the hole width should be the same width as the inner portion of the screw (minus the thread).
Expansion Bolts: the hole should be the same width as the outer metal casing on the bolts.
- The included chain and carabiners allows for two installation options (see page 3). The hanging point will need to be a suitable height to match with the hammock chair height. Ensure the hanging height is suitable before installation.

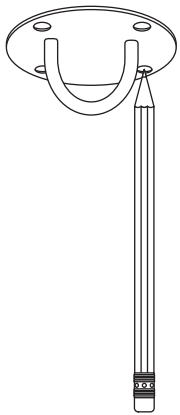

Position the round eye pad on the hanging surface, then mark the positions for the four holes.

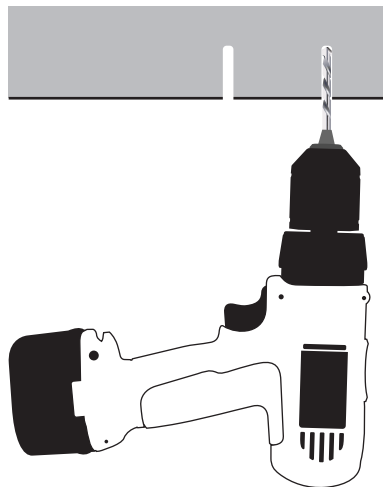

Select a suitable drill bit and drill pilot holes.

Lag Screw: 5mm x 70mm

Expansion Bolt: 11.5mm x 60mm

NOTE: pilot hole sizes noted are approximate. Before drilling, measure hardware to ensure accuracy.

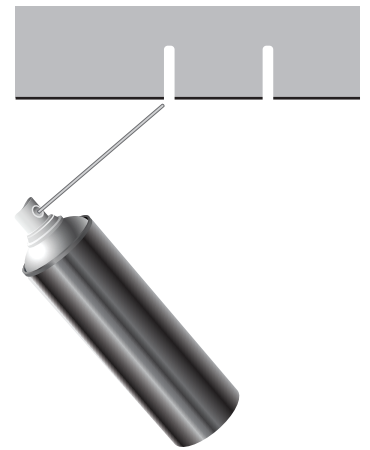

Clean loose debris from the pilot holes using a blower, canned air or a vacuum.

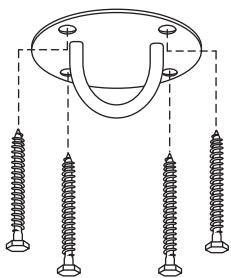

If installing into wood, position the round eye pad over the pilot holes and drive the screws into the pilot holes.

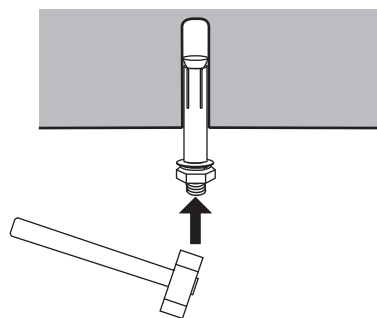

If installing into concrete/brick, tap in the expansion bolts. Expand them enough to hold in place by tightening the nuts, **do not fully tighten yet!**

Remove the washers and nuts.

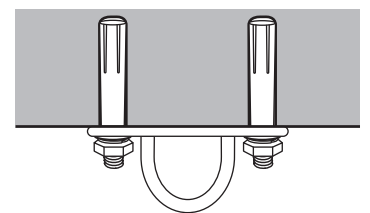

Position the round eye pad over the expansion bolts. Place the flat washer then split washer on the bolt, then hand-tighten the nut. Fully tighten all hardware with a wrench.

HANGING OPTIONS

Always test the strength of the installation setup before using the chair.

Gently lower yourself into the chair, avoiding large and sudden movements that could weaken installation hardware and/or potentially damage the mounting surface.

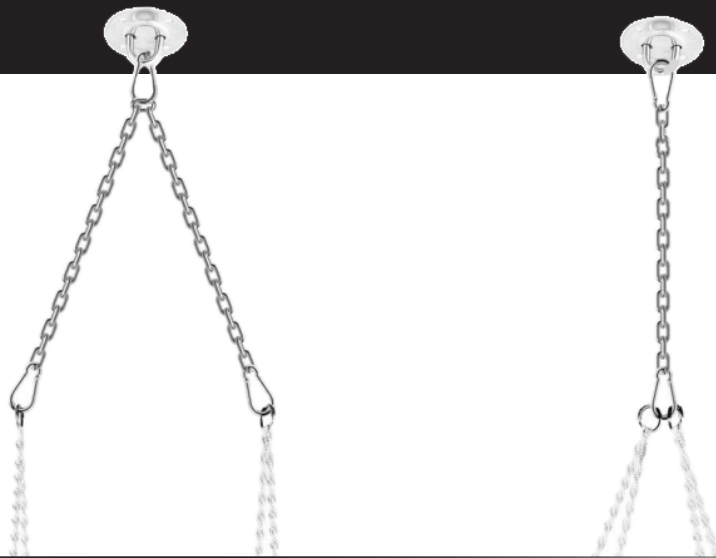

USE & CARE

- **SAFE USE:** Do not swing, bounce, jump, twist, or make other excessive movements while using this chair. Misuse of the hammock chair, such as using it like a swing or exceeding the weight limit, can lead to serious injury and damage the product.
- **INSPECT:** Before each use, inspect the ropes, fabric, and frame for wear or weakness.
- **SUN EXPOSURE:** All fabrics will eventually fade and degrade from sun exposure. The less direct sunlight the hammock chair is exposed to, the longer the life of the hammock chair will be.
- **CHILDREN:** Supervise children at all times while using this product. Do not allow children or pets to play in the hammock chair. Excessive swinging or rough play may damage the hammock chair and could cause injury.
- **CLEANING:** Clean when fabric is soiled or staining is present, and before storage.
- **STORAGE:** Store indoors, in a dry location. Bring the chair indoors during inclement weather, winter, and when it will not be used for an extended time. Ensure the chair is completely dry before storing to prevent mold and mildew growth.

CLEANING



HAND-WASH ONLY



DO NOT USE BLEACH OR FABRIC SOFTENERS



LAY FLAT TO DRY

Spot clean with a damp cloth or hand-wash in a bathtub or kiddie pool using mild soap or detergent and a soft-bristled scrub brush. Soaking may be required for heavily soiled material. Keep the galvanized O-rings out of the water as much as possible.

Thoroughly rinse all soap residue. Thoroughly air-dry on a flat surface to prevent the ropes from stretching. The ropes may shrink slightly while drying, but will stretch back out with use.

! SAFETY STATEMENTS & WARNINGS !

- Before each use, inspect your hammock chair for wear or weakness. Do not use if the ropes are frayed, fabric is torn, or the frame appear damaged.
- Excessive swinging and other rough play may result in serious injuries as well as potential property damage.
- Small children should not use the hammock chair unsupervised.
- Pets should not be allowed into hammock chairs as it may result in injury or damage to the product.
- Do not exceed the recommended weight capacity of the hammock: 250 pounds.
- Never untie the ropes.

Any modification to the product or failure to follow recommended care will void the product warranty.