

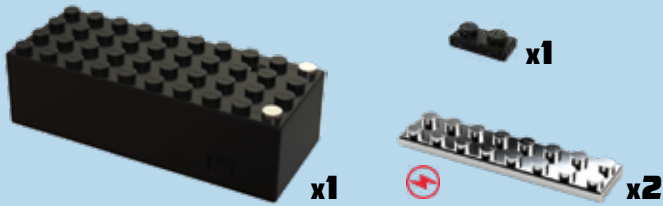

POWER BLOX™ LIGHT 'N FLIGHT

ONLINE ASSEMBLY MANUAL

 = Tin plated block



1

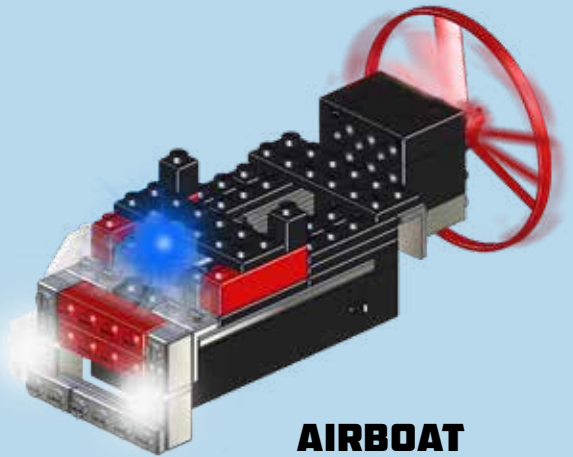
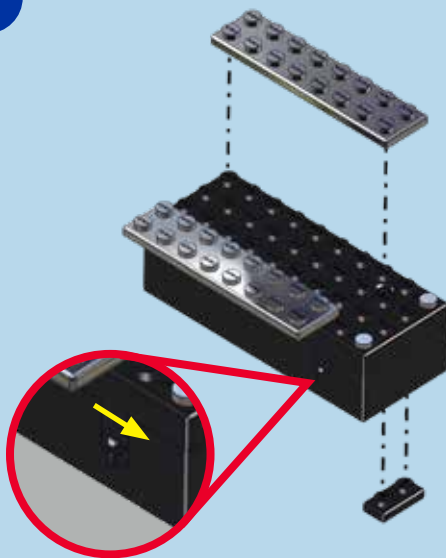

AIRBOAT

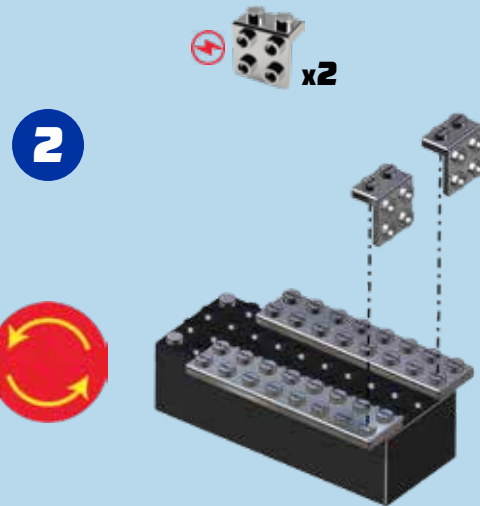

2

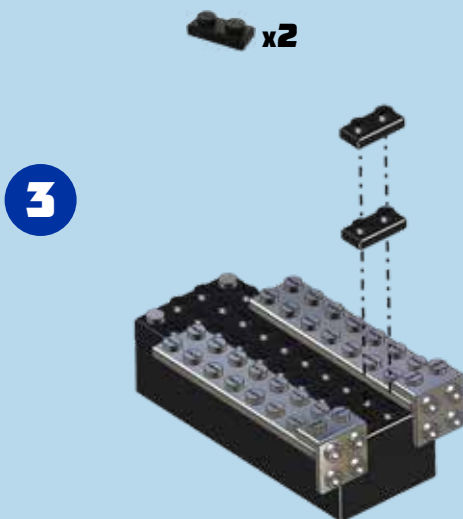

3

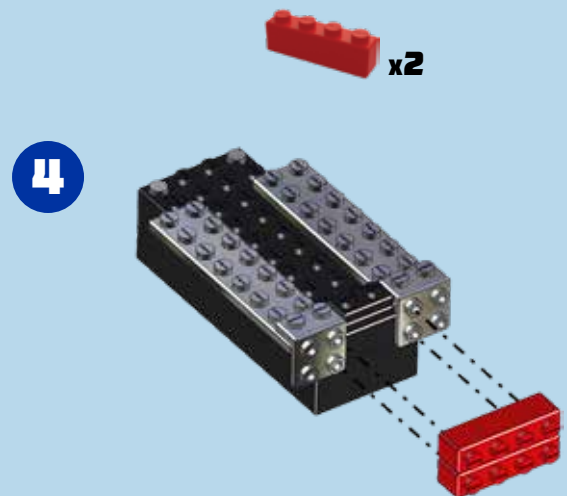

4

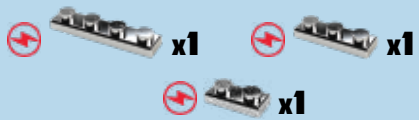

5

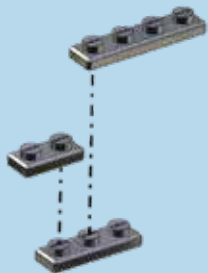

6

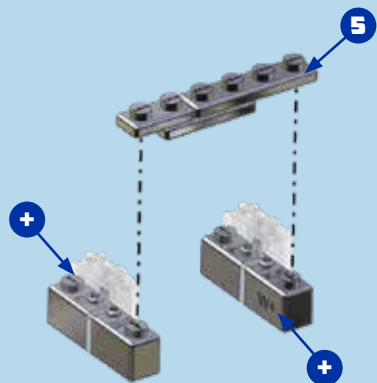

7

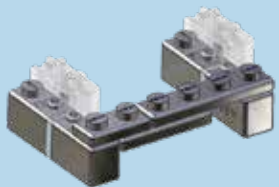

8

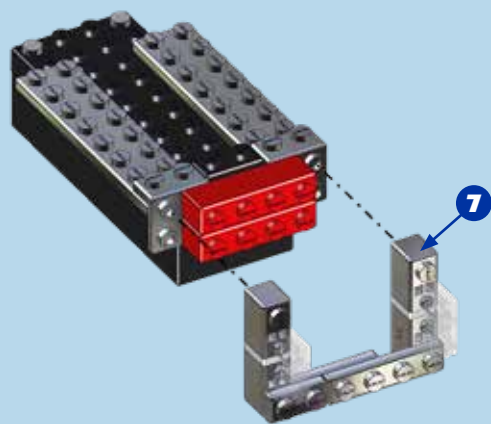

9

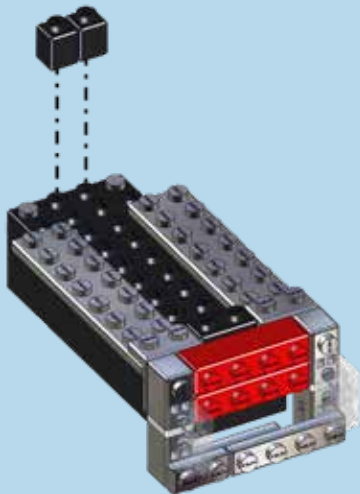

10

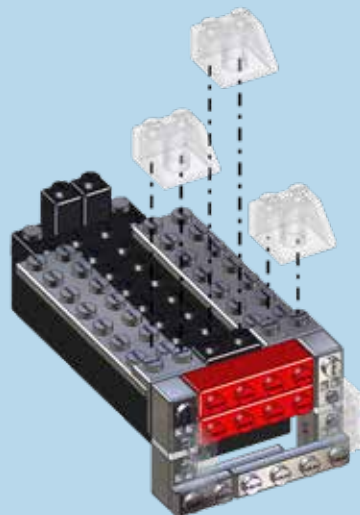

11



x1

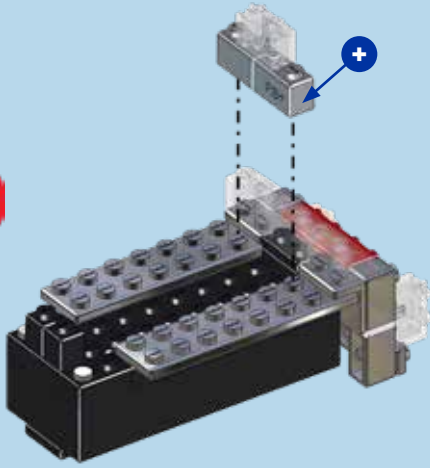

12



x4

x2

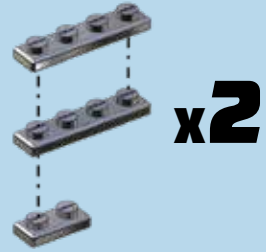

x2



x1

13

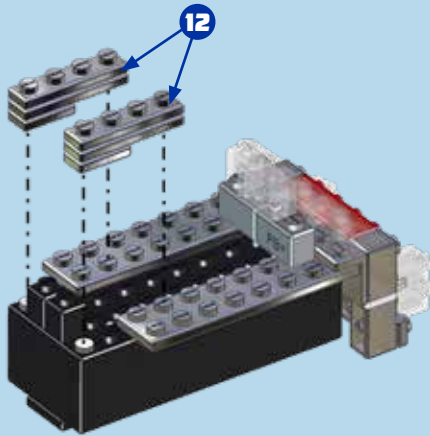

12

14

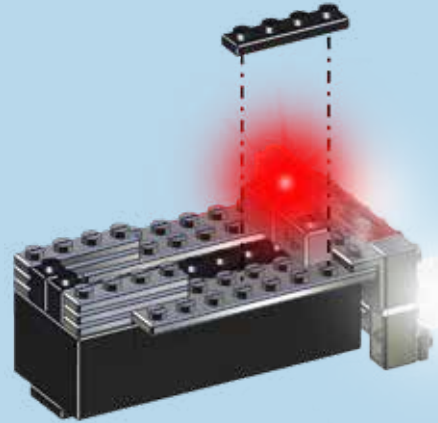

15



x2

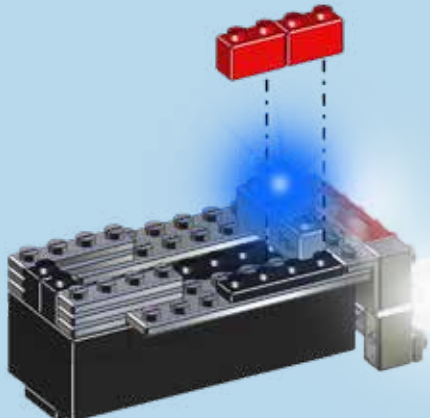

16



x2

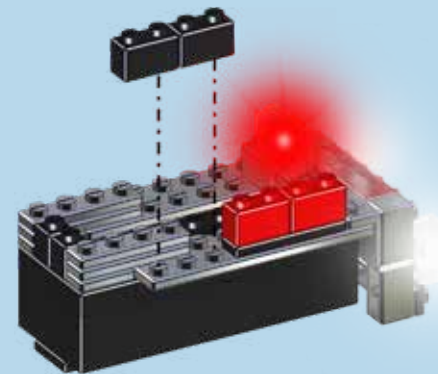

17

x1

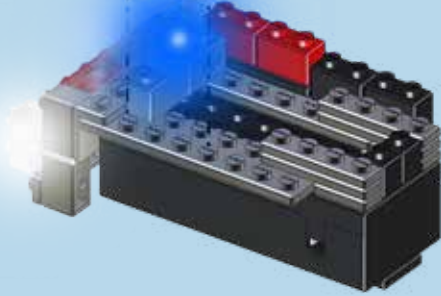

18

x1

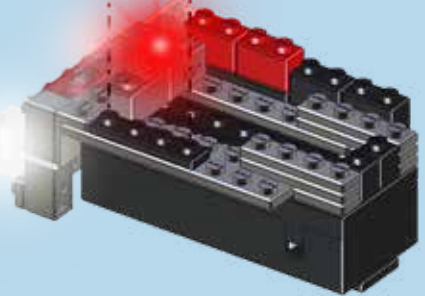

19

x2

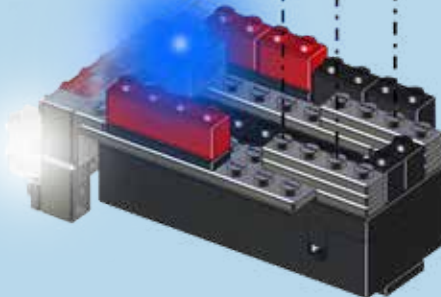

20

x3

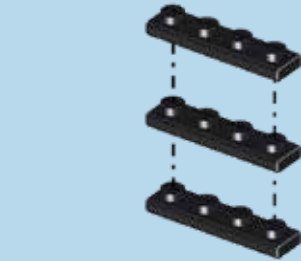

21

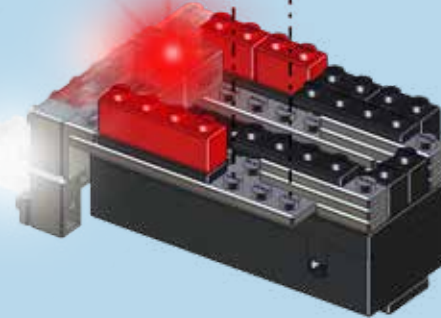

22

x2

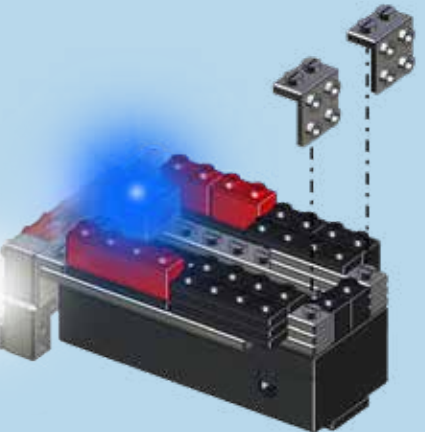

23

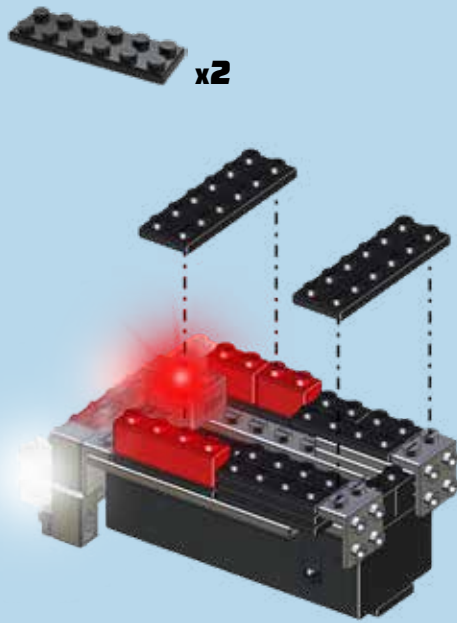

24

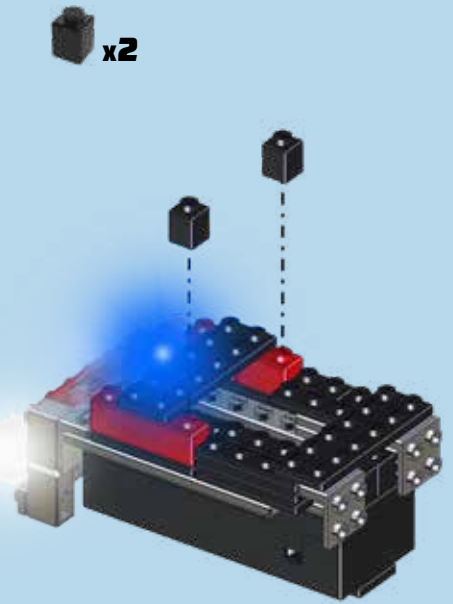

25

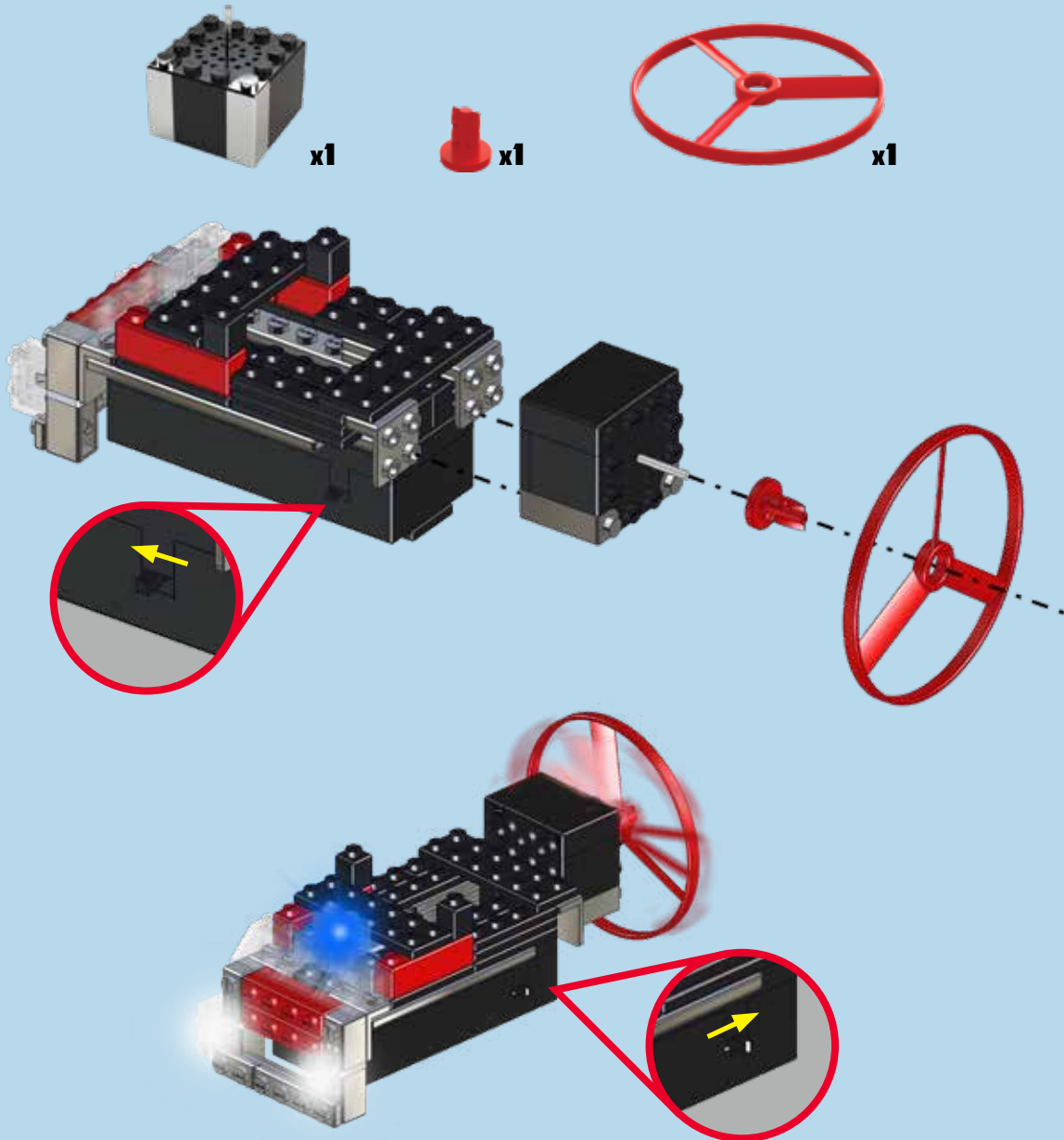

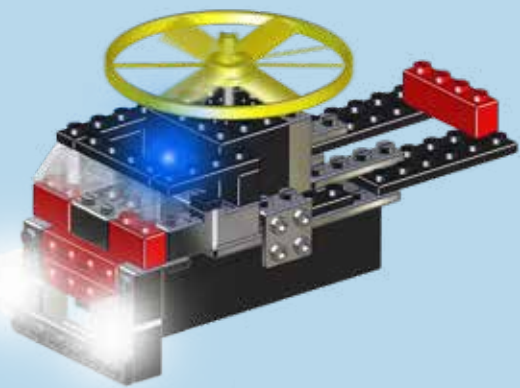

HELICOPTER

 = Tin plated block



x2

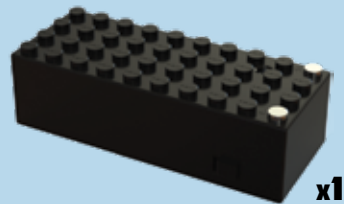

x1

1

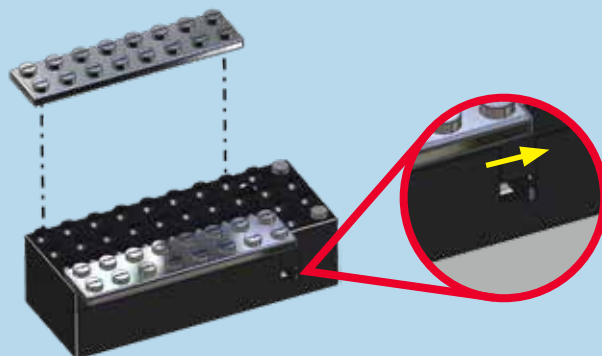

2

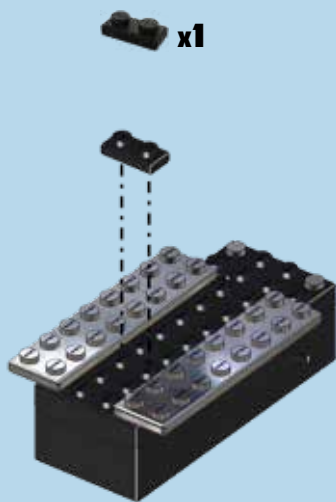

3

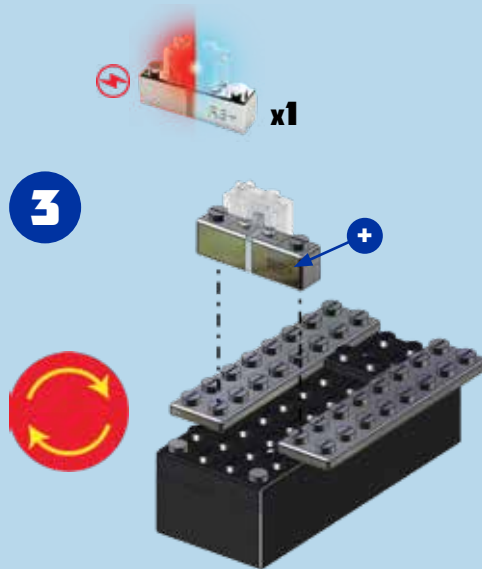

4

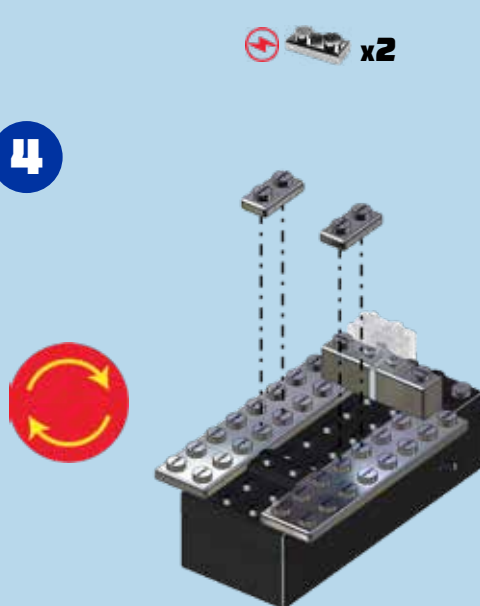

5

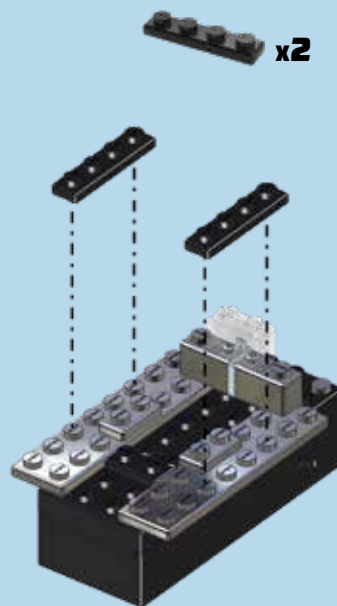

6

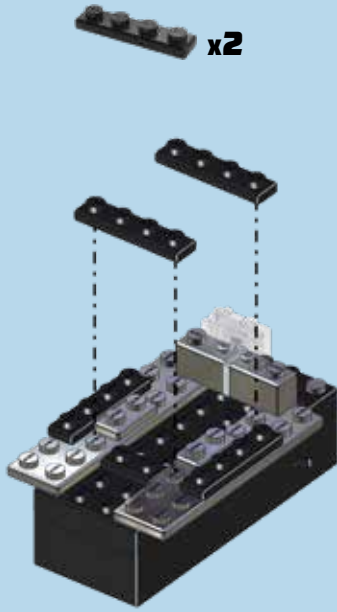

7

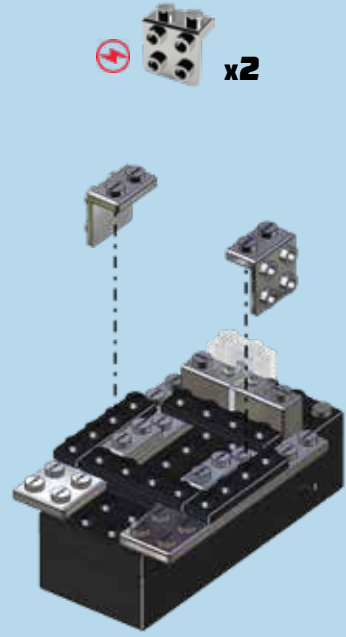

8

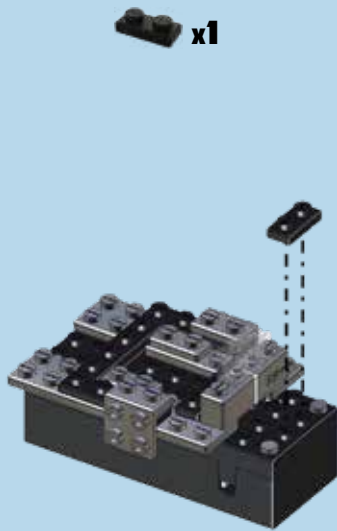

9

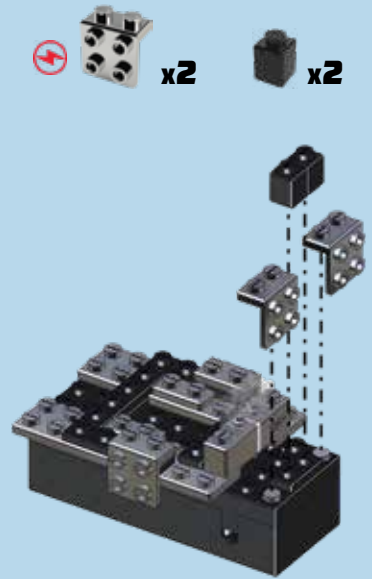

10

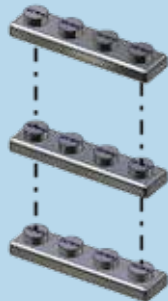

11

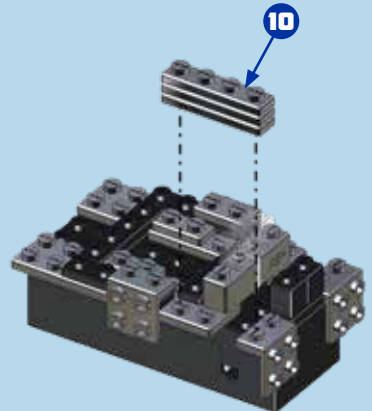

12

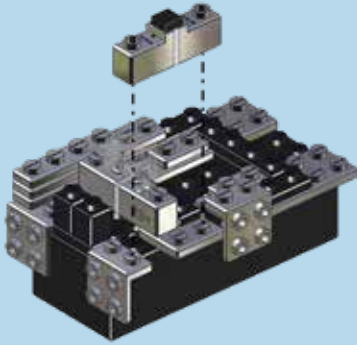

13

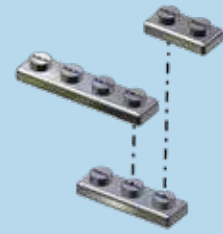
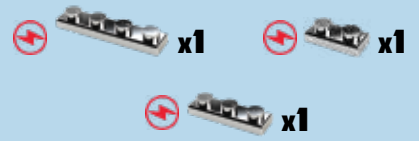

14

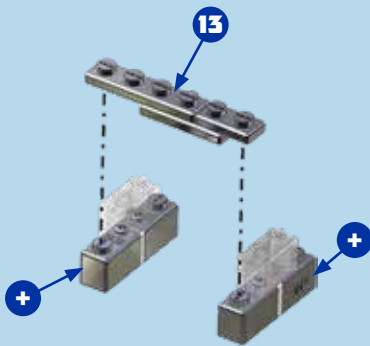

15

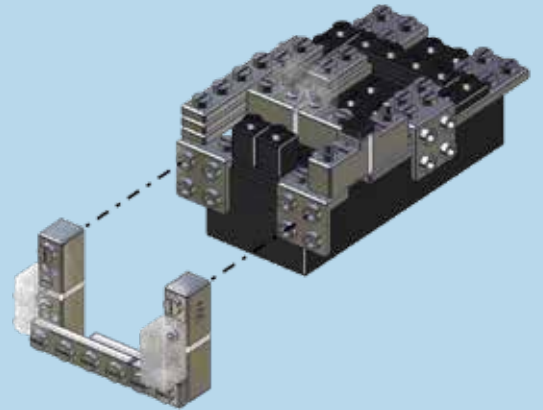

16

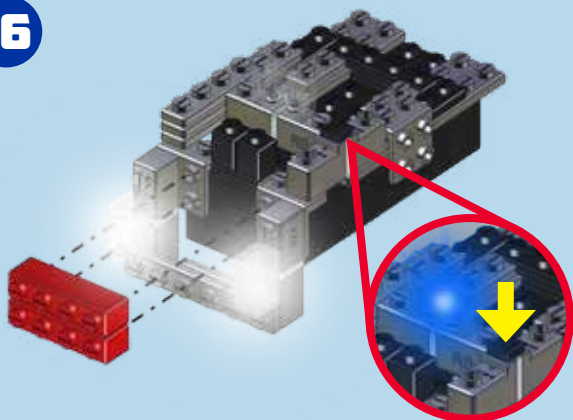

17

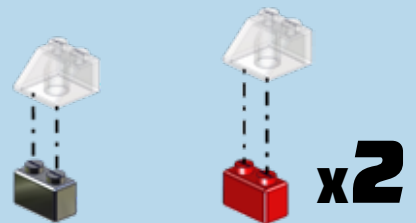

18

 x1



19

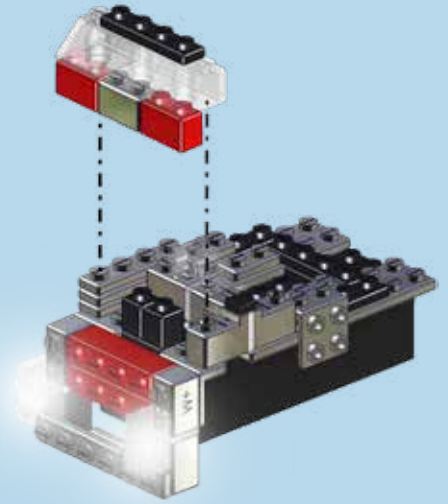

20

 x2

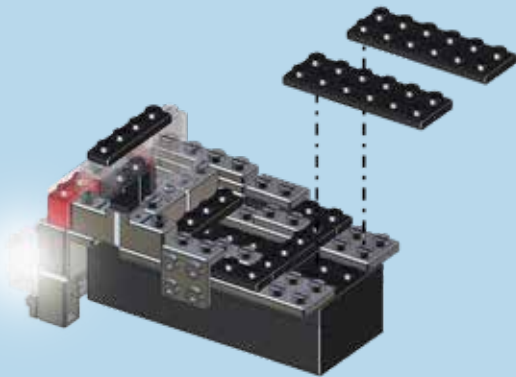

21

 x2

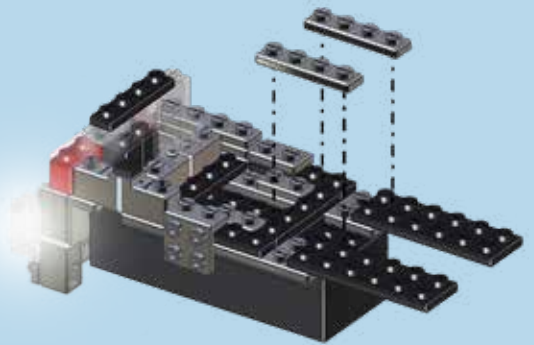

22

 x1

 x1

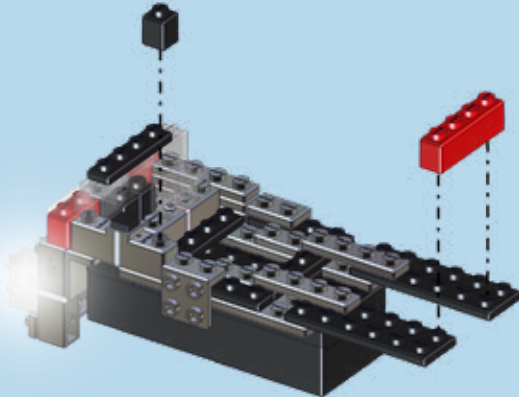

23

 x1

 x1

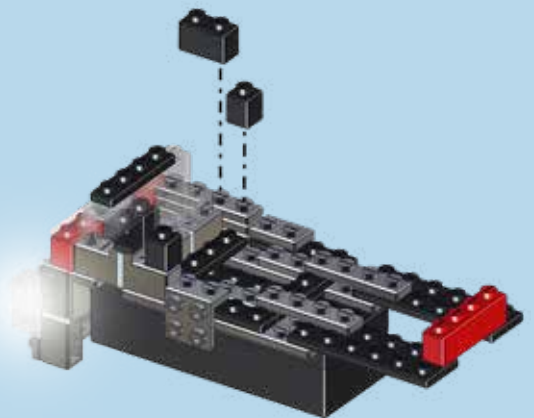

24

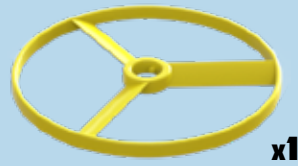
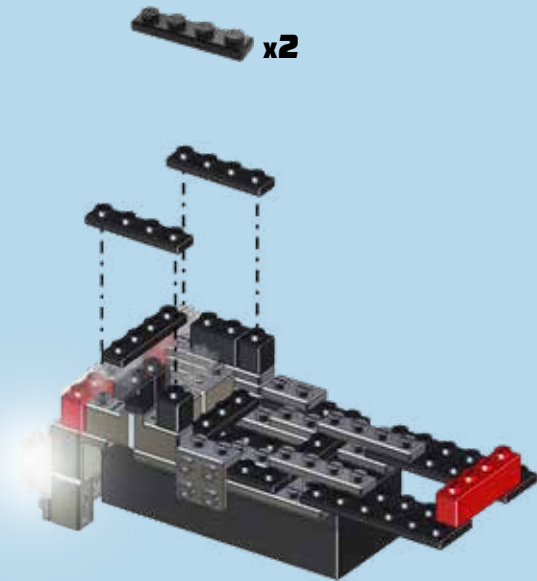

25

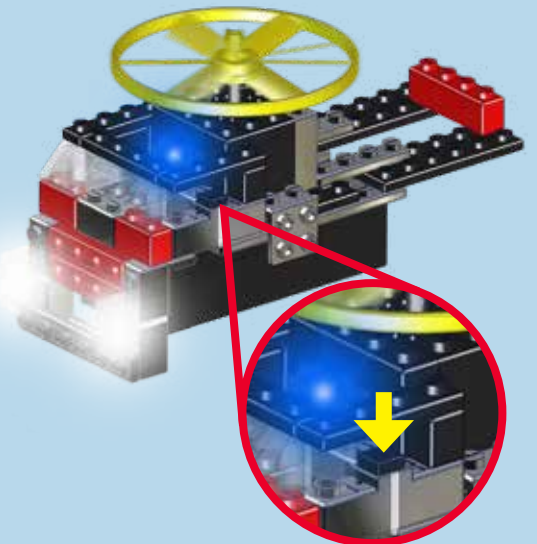
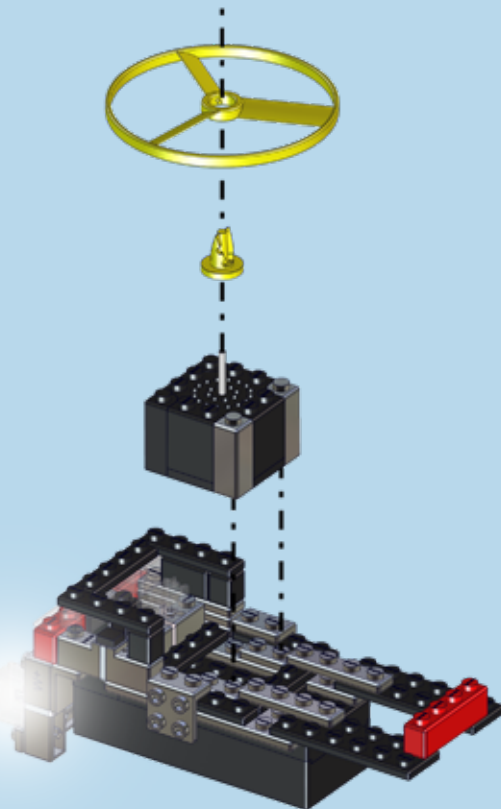

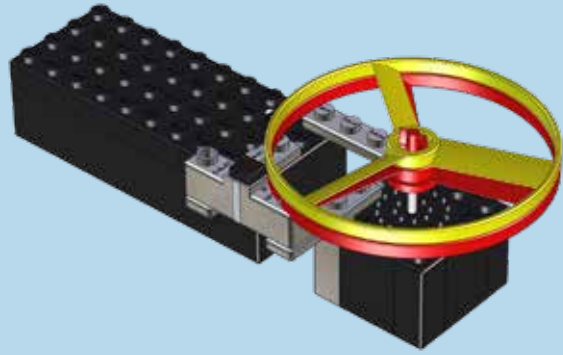

DOUBLE FAN LAUNCHER

 = Tin plated block

  x1



1

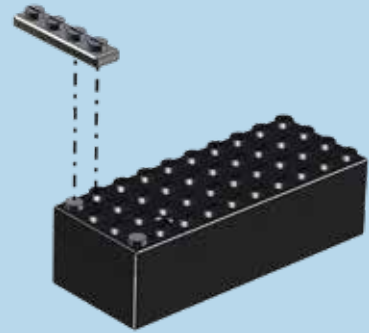

  x1

2

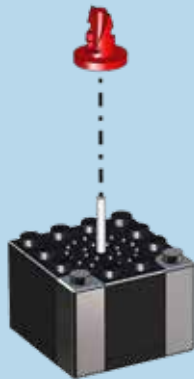

3

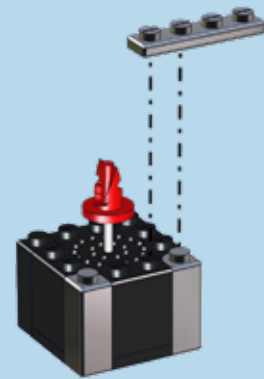

4



5

4

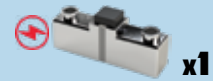
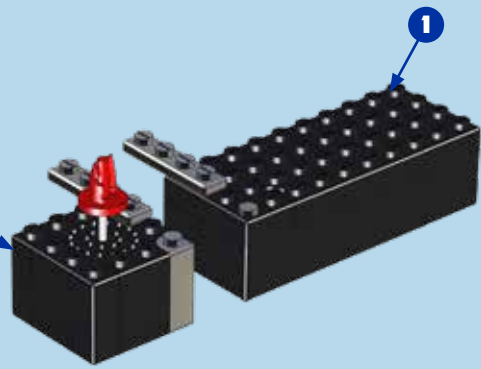

6

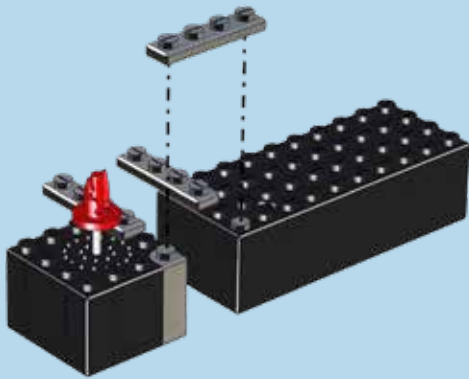

7

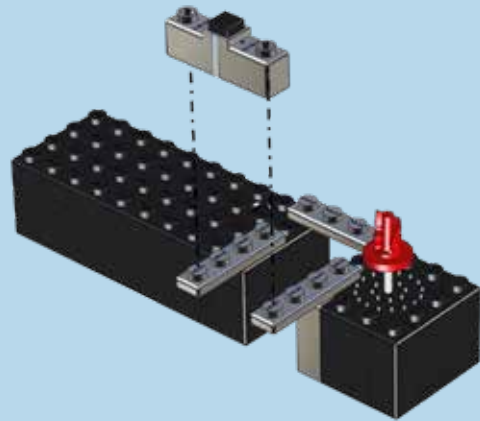

8

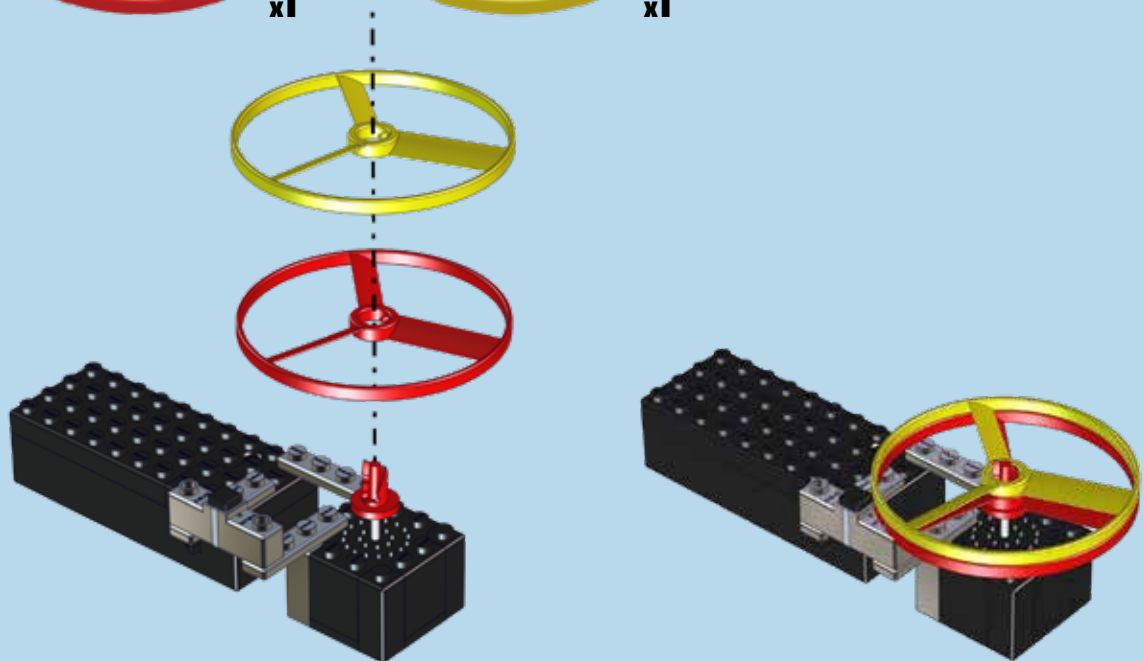

 = Tin plated block

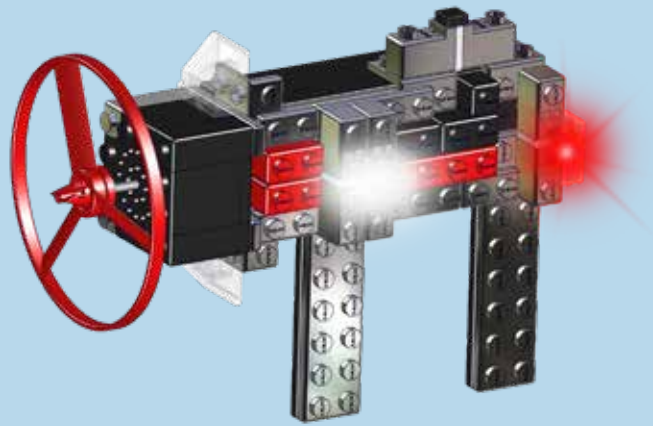

FAN SHOOTER

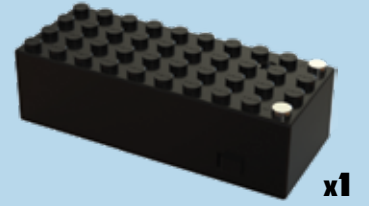
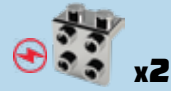

1

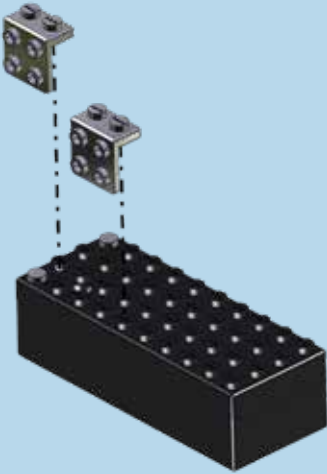

2

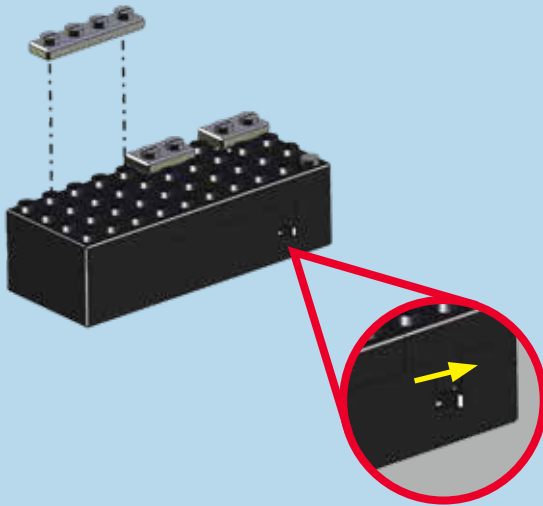

3

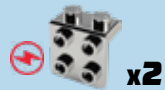
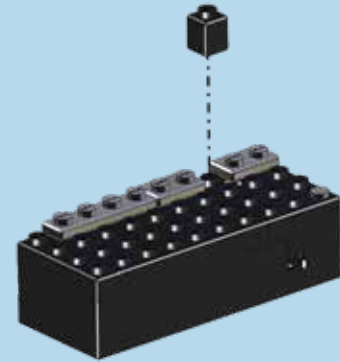

4

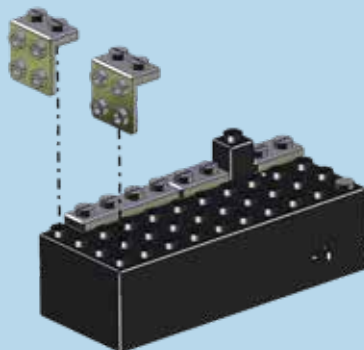

5

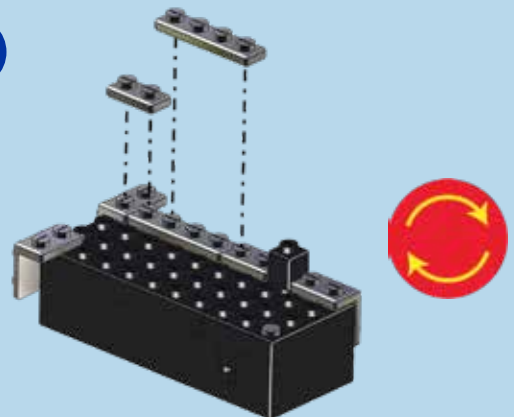

 x2

6

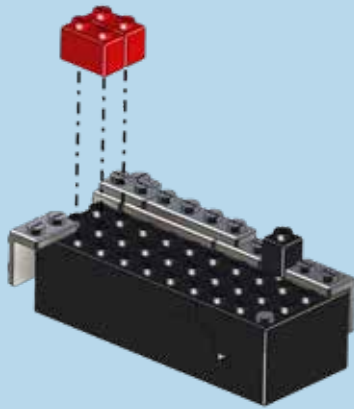

 x2

7

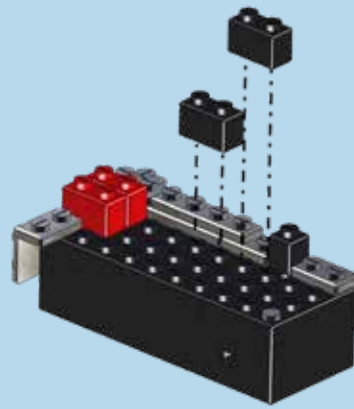

 x1

8

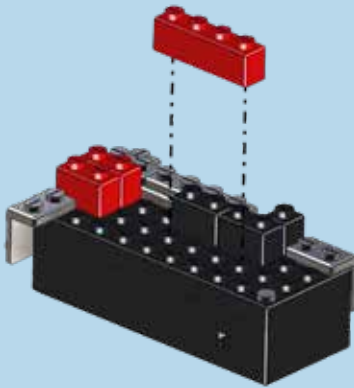

 x1

9

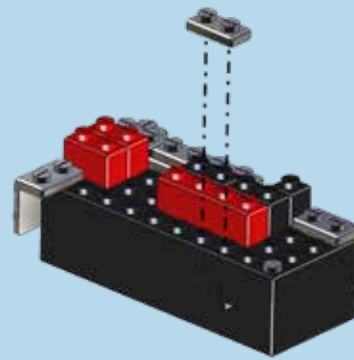

 x2

 x2

10

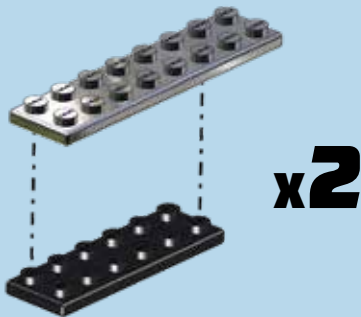

11

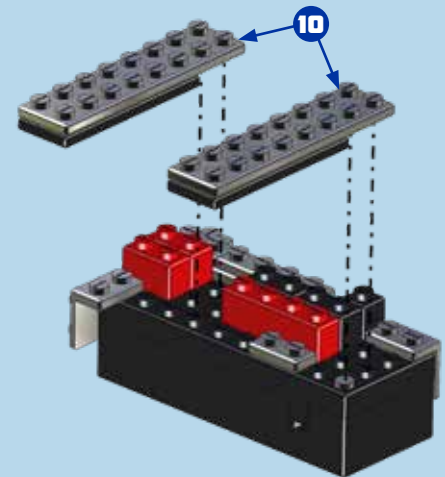

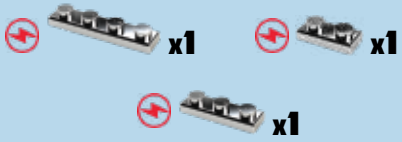

12

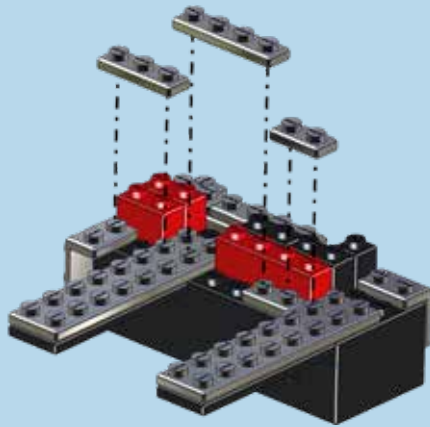

13

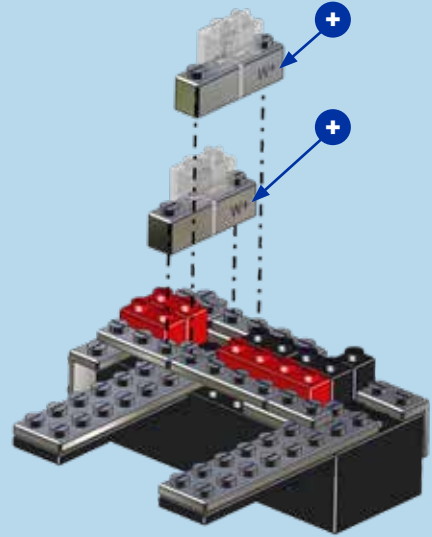

14

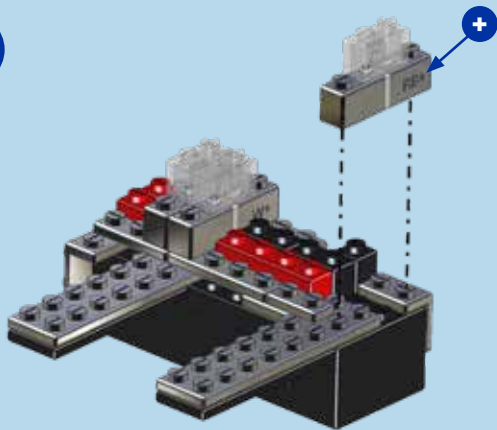

15

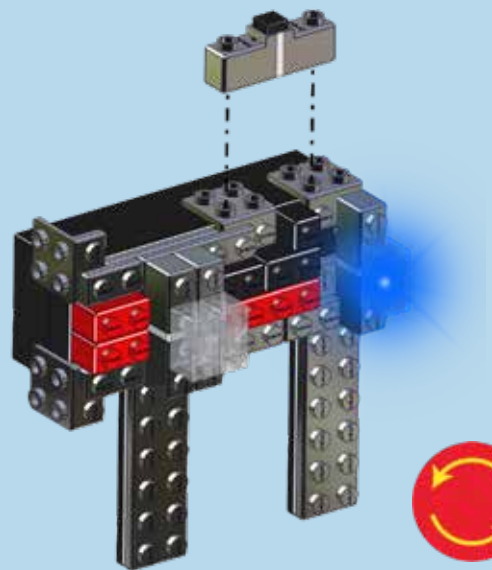

16

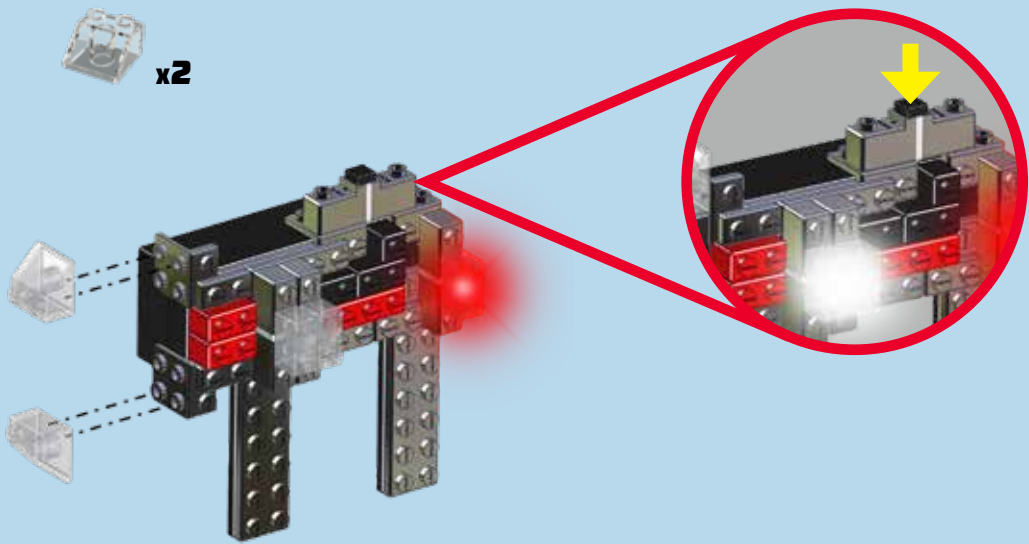

17

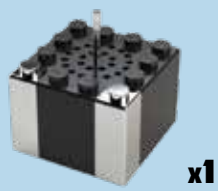
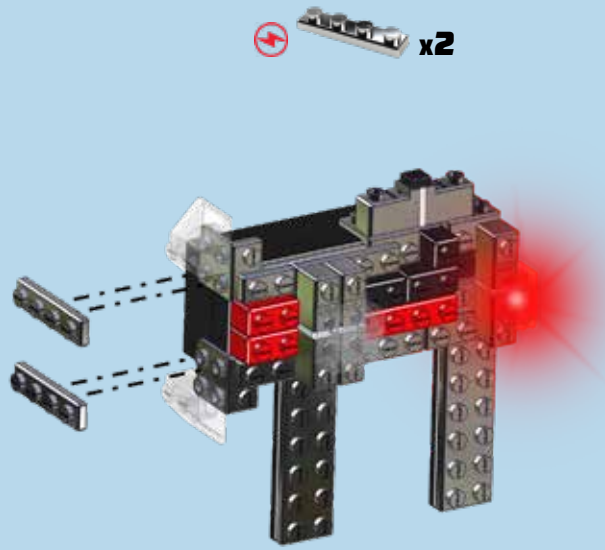

18

