



Build your own FAN LAUNCH LIGHT SHOW



59
PROJECTS

**Instruction
Manual**

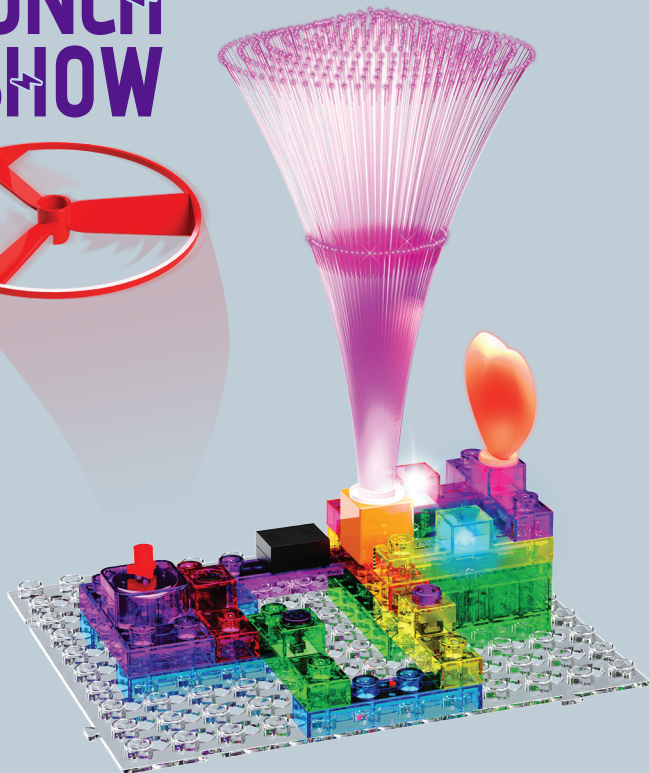



WARNING: SHOCK HAZARD

Never connect E-Blox® Circuit Blox™ to the electrical outlets in your home in any way!



WARNING:

Only use the battery holder with the cover securely in place.



WARNING: CHOKING HAZARD

Small parts. Not for children under 3 years.



WARNING: MOVING PARTS

Do not touch the fan while it is spinning.



WARNING: THIS PRODUCT CONTAINS SMALL MAGNETS

Swallowed magnets can stick together across intestines causing serious infections and death. Seek immediate medical attention if magnet(s) are swallowed or inhaled.



CIRCUIT BLOX™



WARNING: Always check your wiring before turning on a circuit. Never leave a circuit unattended while the batteries are installed. Never connect additional batteries or any other power sources to your circuits. Discard any cracked or broken parts.

Adult Supervision:

Because children's abilities vary so much, even with age groups, adults should exercise discretion as to which experiments are suitable and safe (the instructions should enable supervising adults to establish the experiment's suitability for the child). Make sure your child reads and follows all of the relevant instructions and safety procedures, and keeps them at hand for reference.

This product is intended for use by adults and children who have attained sufficient maturity to read and follow directions and warnings.

Never modify your parts, as doing so may disable important safety features in them, and could put your child at risk of injury.

FCC Notice: Please note that changes or modifications not expressly approved by the party responsible for compliance could void the user's authority to operate the equipment.

NOTE: This equipment has been tested and found to comply with the limits for a Class B digital device, pursuant to Part 15 of the FCC Rules. These limits are designed to provide reasonable protection against harmful interference in a residential installation.

This equipment generates, uses and can radiate radio frequency energy and, if not installed and used in accordance with the instructions, may cause harmful interference to radio communications. However, there is no guarantee that interference will not occur in a particular installation. If this equipment does cause harmful interference to radio or television reception, which can be determined by turning the equipment off and on, the user is encouraged to try to correct the interference by one or more of the following measures:

- Reorient or relocate the receiving antenna.
- Increase the separation between the equipment and receiver.
- Connect the equipment into an outlet on a circuit different from that to which the receiver is connected.
- Consult the dealer or an experienced radio/TV technician for help.



Batteries:

- Use only 1.5V “AA” type, alkaline batteries (not included).
- Insert batteries with correct polarity.
- Non-rechargeable batteries should not be recharged.
- Rechargeable batteries should only be charged under adult supervision, and should not be recharged while in the product.
- Do not mix old and new batteries.
- Do not mix alkaline, standard (carbon-zinc), or rechargeable (nickel-cadmium) batteries.
- Remove batteries when they are used up.
- Do not short circuit the battery terminals.
- Never throw batteries in a fire or attempt to open its outer casing.
- Batteries are harmful if swallowed, so keep away from small children.

Basic Troubleshooting

1. Most circuit problems are due to incorrect assembly, always double-check that your circuit exactly matches the drawing for it.
2. Be sure that parts with positive/negative markings are positioned as per the drawing.
3. Be sure that all connections are securely made.
4. Try replacing the batteries. Note: Rechargeable batteries do not work as well as alkaline batteries.

E-Blox® is not responsible for parts damaged due to incorrect wiring.

Note: If you suspect you have damaged parts, you can follow the Advanced Troubleshooting procedure on page 14 to help determine which ones need replacing.

About Electricity (Science)

1. What is Science?

 Q: What do we mean when we say “Science”?

 A: **Science** is defined as the **intellectual** and **practical** activity encompassing the systematic study of the structure and behavior of the physical and natural world through observation and experiment.

Early scientists were curious people that wondered what made lightning. They decided to experiment to see if they could understand lightning and even make their own somehow.



2. Who Discovered Electricity?

 Q: Who was the first scientist to study electricity?

 A: In ancient Greece, it was found that rubbing fur on amber produced an attraction between the two. This discovery is credited to the philosopher **Thales of Miletus**. One day, when he was polishing his amber at home, he found that a piece of fur was attracted by the amber after he put it on the desk. Then he split them, but it happened again. So he made a record about the phenomenon. It took many centuries before anyone was able to connect this phenomenon with electricity and a century before electrical current was put to practical use.



3. What Other Ways Does Science Help Us?

 Q: What are some areas of Science?

 A: A few major Sciences are Biology, Chemistry, Astronomy, and Physics.

Biology is the study of living things like plants & animals.

Chemistry is the study of substances and how they react when you combine them. Things like the plastic in your remote and the batteries that make it work.

Astronomy is the study of the universe.

Physics is the study of matter, energy, and forces that are on structures like a tall tower.

The science of **Electronics** is considered a branch of Physics.



4. Can Science Help Predict the Weather?

 Q: What Sciences were used to help weather prediction?

 A: Putting a satellite into orbit that could monitor the weather required the use of almost all the Sciences.

Astronomy and **Physics** were needed to understand the forces of gravity and how objects stay in orbit. **Chemistry** was needed to make materials that could withstand the heat and cold and to make fuels to get the satellite into orbit. **Electronics** was used to study the weather and transmit it back to earth. **Biology** was needed to study how repair people could work in orbit.

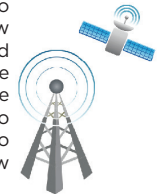

About Electricity (Technology)

5. What is Technology?

 Q: What is technology and who used technology in the past?

 A: Technology is the application of scientific knowledge for practical purposes. Dating back to the 18th century, **Benjamin Franklin** (a famous American) proved that lightning was caused by electricity by performing an experiment in which an electrical conductor would be used to extract power from a thundercloud. In the experiment, he flew a kite with a metal key attached to it into a suitable cloud. The precise historical details are unclear, but he may have then retrieved the key and discharged electricity from it. Later, in 1799, he invented the lightning rod, a device that served a practical purpose.



6. Technical Terms

 Q: What terms do electrical technicians need to know?

 A: When technicians work on circuits and appliances there are some terms they need to know. **Current** is the movement of electrons and is measured in **Amperes (Amps)**, which is named in honor of André-Marie Ampère. **Resistance** is the opposition of the flow of electric current and is measured in **Ohms**, which is named after George Ohm. **Electro-Motive Force (EMF)** that pushes the electrons through the resistance is measured in **Volts**, named after Alessandro Volta. **Electrical Power** is the rate, per unit time, at which electrical energy is transferred by an electric circuit and is measured in **Watts**, named after the famous technical inventor James Watt.



7. Technology in Everyday Life

 Q: Where do we see Technology?

 A: Since **Technology** is the application of scientific knowledge, we see it every day when we watch television, cook in an electric pot, ride on a train that is powered by electricity, and more. Repairmen that fix our furnaces or our air-conditioning units are technicians because knowledge of how the science was used to make things hot and cold helps us repair a broken device.



8. Is There an Age Requirement to be a Technician?

 Q: How old do you have to be to become a Technician?

 A: Let me tell you a story about a girl named Becky. She was only 10 years old when she was attempting to do her homework in her mom's car. As it got darker outside, she had the idea that there should be a way to make her paper easier to see in the dark. She began playing around with **phosphorescent** materials, which exhibited light without heat. She then used phosphorescent paint to cover an acrylic board and The **Glo-Sheet** was created. At the ripe old age of 12, Becky became the youngest woman to be approved for a U.S. patent for her Glo-Sheet invention.



About Electricity (Engineering)

9. What is Engineering?

 Q: What is Engineering? What do engineers do?

 A: **Engineering** is the application of **Science, Technology,** and **Mathematics** to make products that are useful to people. Engineers are skillful in using their knowledge to make products. For example, surge protectors transfer current from the electrical wall outlet to the electrical appliances plugged into it while protecting the appliances from large spikes of electricity which could damage them. Some surge protectors have many sockets to plug computers and TVs into them, while others only have two. The design is an engineer's job.

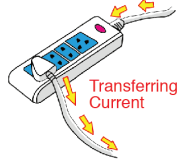

10. Is Engineering only about Electronics?

 Q: Besides Electronics what else do Engineers do?

 A: Engineers must design the products to be the most appealing at the best price. Product appearance helps marketing sell the product. Product performance is also important and engineers are given specifications by marketing to meet their requirements. Safety is always very important. An audio device should only be loud enough to serve the specifications. **Production Engineers** use electronic and magnetic sensors to automate production. **Civil Engineers** design roads and bridges that are safe for everyone to use.



11. Engineering and Electricity Generation

 Q: Do engineers help make electricity for daily use?

 A: Yes! So far they have designed systems that use the seven fundamental methods of directly transforming other forms of energy into electrical energy:

Fossil-fuel, Biomass, Hydro/Tidal, Wind, Nuclear, Mechanical Power Generation, and Solar Thermal Energy.

Certainly there will be more methods for electricity generation to be found, since the engineers, like artists, are always creating.

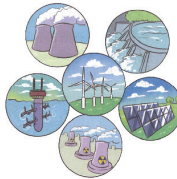

12. Environmental Engineering - Battery Recycling

 Q: How do Engineers help protect our environment?

 A: **Batteries** contain a number of toxic chemicals and their improper disposal may cause soil contamination and water pollution. Engineers know that most typical kinds of batteries can be recycled, especially **Lead-Acid** automotive batteries which are nearly 90% recycled today. **Nickel-Cadmium (Ni-Cd), Nickel Metal Hydride (Ni-MH), Lithium-ion (Li-ion)** and **Nickel Zinc (Ni-Zn)** can also be recycled. Engineers are always looking for ways to make products safe like integrating fuses into their designs to prevent overheating and fires.



About Electricity (Mathematics)

13. Ohm's Law

Ohm's Law states that **Voltage** equals **Current** multiplied by Resistance. If V = Voltage, I = Current, and R = Resistance, then mathematically Ohm's Law is $V = I \times R$ where "x" stands for "multiplied by". Since the law starts with Voltage, we need a voltage source or a **Power Supply**. There are both **DC (direct current)** and **AC (alternating current)** power supplies.

Batteries are also a source of DC voltage. Using **Algebra**, any one unknown can be calculated if the other two variables are known. For example, if $V = 9$ Volts and $R = 1,000$ Ohms, then $I = 0.009$ Amp or 9 milliamps.

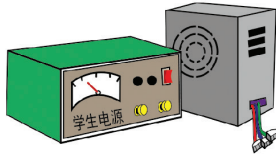

14. Switches and Power

A **switch** is a device that has a position of **ON** or **OFF** and may control other components in digital electronic circuits. It is used for power connection and disconnection. **Power** is the product of the **Current** in a device multiplied by the **Voltage** across it. **Electric Power** is expressed in **Watts**. Mathematically this is expressed as $W = V \times I$. If you have a 60 Watt light that is on a voltage of 120 Volts, then the current can be calculated to be 60 Watts divided by 120 Volts, which equals 1/2 Amp. Some switches are controlled by magnets and others by temperature.

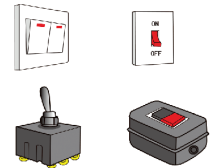

15. Using Mathematics to Calculate Fuses

Many different appliances can be connected to draw current from the outlets in your homes. If these outlets are all connected to one fuse, then the fuse must be able to handle the sum of all the currents being drawn. **Fuses** are used in the battery holder that comes with this product. Each current drawn from any outlet in your home will add up as the appliances are turned ON because they are all connected in parallel.



16. Calculating Resistance

Conductive paths are used to connect circuits and transfer electricity. If the voltage on one end of the conductor is lower than on the other end when current is flowing, then the conductor has resistance. The voltage drop on the conductor divided by the current in the conductor is the **Resistance** of the conductor or wire. In Mathematical terms and from **Ohm's Law**, this would be stated as $R = V \div I$. If the voltage drop is 2 Volts when 4 Amps is flowing, then the resistance of the conductor is 1/2 Ohm.

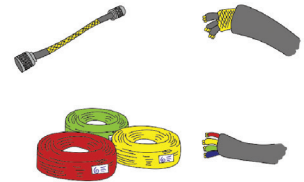

About Electricity (STEM)

17. Circuit Blox™

For Circuit Blox™, the definition of an electrical circuit is: The complete path for an electric current flow, usually including the source of electric energy. The path shown in the circuit below is from the battery, through the blue 2-wire, through the motor under the fan, through the blue 4-wire, through the switch, through the blue 2-wire, and then back to the battery. If the switch in this circuit is closed, then current will flow from the battery through all the components and back to the battery. If enough current flows, the motor will spin and launch the fan. If the switch is open, nothing will happen since it is an open circuit with no current.

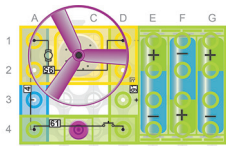

18. Short Circuits in Circuit Blox™

The battery holder that comes with your Circuit Blox™ Kit is fully protected. A short circuit indicator LED lights and a beeper sounds if any of the outputs are shorted or under a high current draw. It is important that you always use this battery holder in the circuits you build to protect the batteries and prevent damage to parts. Even shorts from one voltage output to another is protected by a patented circuit and will indicate an excessive current. This circuit uses resettable **Positive Temperature Coefficient fuses (PTCs)**. Circuit Blox™ kits are always approved by independent safety laboratories to insure all users will be able to experiment without worry of harm to parts or themselves.

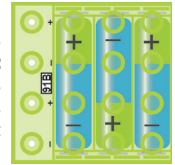

19. Sound and Light

There are many modules in Circuit Blox™ that will produce different sounds and different light effects.

The **Three-in-One Module**, for example, has two control inputs (T1, T2), a speaker connection (SP1, SP2), and music & space sound selects (I/O1, I/O2).

By proper connection of parts with the Three-in-one module many special effects can be generated and triggered in different ways. This module will be used to simulate many of the different interesting problems in the fields of **Sound Technicians, Medical Engineering, Communication Engineers, Home Security**, and much more.

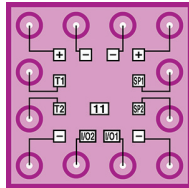





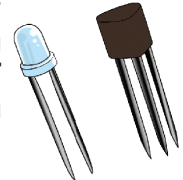

20. Semiconductors

Semiconductors have properties that can control current flowing through a conductor similar to a faucet controlling the flow of water in a pipe. A **diode** acts like a check valve in a water pipe by only letting current flow in one direction. A **Light Emitting Diode (LED)** produces light when very little current flows. Different colored LEDs are made and some LEDs can even produce **Laser** light similar to handheld pointers or gun scopes. **Transistors** have three leads and one is used to control the current between the other two.









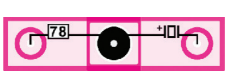

Parts List (colors and styles may vary) Symbols and Numbers

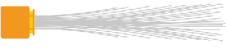
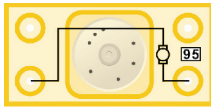
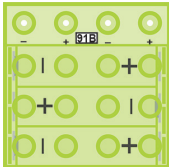
Important: If any parts are missing or damaged, **DO NOT RETURN TO RETAILER.** Call toll-free (855) MY EBLOX (693-2569) or e-mail us at: support@myeblox.com. Customer Service: 1574 Barclay Blvd., Buffalo Grove, IL 60089 U.S.A.

Qty.	Name	Symbol	Part #
3	4-wire Block		6EB2X04
1	Press Switch		6EB2X61
1	Switch		6EB2X62
1	LED		6EB2X69
1	Bi-directional LED		6EB2X71
1	Colorful LED		6EB2X72
1	Lamp		6EB2X76

Parts List (colors and styles may vary) Symbols and Numbers

Qty.	Name	Symbol	Part #
1	Alarm		6EB2X78
1	Reed Switch		6EB2X83
1	Magnet		6EB2X07
1	Fiber Optic Tree		6EB2X40
1	Motor		6EB2X95
1	Battery Holder		6EB2X91B
1	Battery Cover		6EB2X91C

Qty.	Name	Symbol	Part #
3	Motor Top		6EB2X64
3	Motor Shaft Cap		6EB2X60A
3	Fan Blade		6EB2X60
1	Base Grid		6EB2X39

How to Use Your E-Blox® Circuit Blox™ Set

E-Blox® Circuit Blox™ parts contain a PC board with connectors so you can build the different electrical and electronic circuits in the projects. Each block has a function: there are switch blocks, a light block, battery block, wire blocks, etc. These blocks are different colors and have numbers on them so that you can easily identify them.

For Example:

This is the press switch, it is green and has the marking 61 on it. The part symbols in this booklet may not exactly match the appearance of the actual parts, but will clearly identify them.



This is a wire block which comes in a single length. The part has the number 4 on it.



You need a power source to build each circuit. The part is marked 91B and requires three (3) 1.5V "AA" batteries (not included). The four connections are marked -, +, -, and +.

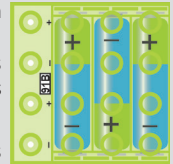

A short circuit indicator LED lights and beeper sounds if any of the outputs are shorted or under a high current draw.

Only use the battery holder when the cover is securely in place.

A large clear plastic base grid is included with this kit to help keep the circuit blocks properly spaced. You will see evenly spaced posts that the different blocks plug into.

Next to the circuit diagram may be a part with an arrow and red circle as shown below. This indicates that the part is installed below other parts and which level it is on.

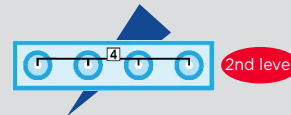

About Your E-Blox® Circuit Blox™ Parts

(Part designs are subject to change without notice).

The **base grid** functions like the printed circuit boards found in most electronic products. It is a platform for mounting parts and wire blocks (though the wires are usually “printed” on the board).

The blue **wire blocks** are just wires used to connect other components, they are used to transport electricity and do not affect circuit performance. They come in different lengths to allow orderly arrangement of connections on the base grid.

The **batteries (91B)** produce an electrical voltage using a chemical reaction. This “voltage” can be thought of as electrical pressure, pushing electrical “current” through a circuit. This voltage is much lower and much safer than that used in your house wiring. Using more batteries increases the “pressure” and so more electricity flows.

The **switch (62)** connects (ON) or disconnects (OFF) the wires in a circuit.

The **press switch (61)** connects (pressed) or disconnects (not pressed) the wires in a circuit, just like the switch does.

The **LED (69)** is a light emitting diode inside the heart, and may be thought of as a special one-way light bulb. In the “forward” direction (indicated by the “arrow” in the symbol) electricity flows if the voltage exceeds a turn-on threshold (between 1.8V to 3.3V typically); brightness then increases. LEDs block electricity in the “reverse” direction.

The **bi-directional LED (71)** is like the others but has red and blue LEDs connected in opposite directions.

The **colorful LED (72)** slowly changes colors (red-green-blue) when connected to a power source.

The **4.5V lamp (76)** contains a special wire (filament) that glows bright when a large electric current passes through it. Voltages above the bulb’s rating can burn out the wire.

The **alarm (78)** converts electricity into sound by making mechanical vibrations. These vibrations create variations in air pressure which travel across the room. You “hear” sound when your ears feel these air pressure variations.

A **reed switch (83)** is an electrical switch operated by an applied magnetic field. When exposed to a magnetic field, the switch closes (ON). When the magnetic field is removed the switch opens (OFF).

A **fiber optic tree (40)** is used with the LED to enhance the light effects.

The **motor (95)** converts electricity into mechanical motion. Electricity is closely related to magnetism, and an electric current flowing in a wire has a magnetic field similar to that of a very, very tiny magnet. Inside the motor are three coils of wire with many loops. If a large electric current flows through the loops, the magnetic effects become concentrated enough to move the coils. The motor has a magnet inside, so as the electricity moves the coils to align them with the permanent magnet, the shaft spins.

DOs and DON'Ts of Building Circuits

After building the circuits given in this booklet, you may wish to experiment on your own. Use the projects in this booklet as a guide, as many important design concepts are introduced throughout them. Every circuit will include a power source (the batteries), a resistance (which might be an LED, lamp, motor, integrated circuit, etc.), and wiring paths between them and back. **You must be careful not to create “short circuits” (very low-resistance paths across the batteries, see examples below) as this will damage components and/or quickly drain your batteries.** Only connect the parts using configurations given in the projects, incorrectly doing so may damage them. **E-Blox® is not responsible for parts damaged due to incorrect wiring.**

Here are some important guidelines:

DO USE EYE PROTECTION WHEN EXPERIMENTING ON YOUR OWN.

DO include at least one component that will limit the current through a circuit, such as the speaker, lamp, LED, integrated circuit (IC, which must be connected properly), or motor.

DO disconnect your batteries immediately and check your wiring if something appears to be getting hot.

DO check your wiring before turning on a circuit.

DO connect the IC using configurations given in the projects or as per the connection descriptions for the part.

DON'T connect to an electrical outlet in your home in any way.

DON'T leave a circuit unattended when it is turned on.

DON'T touch the motor when it is spinning at high speed.

Examples of SHORT CIRCUITS – NEVER DO THIS!

Placing a wire block directly across the battery holder is a SHORT CIRCUIT, indicated by a flashing LED in the battery holder.

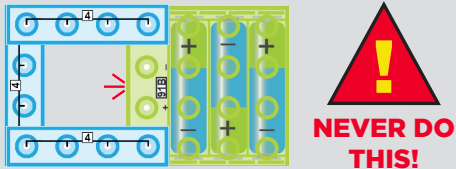
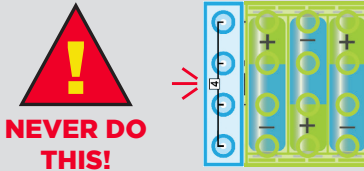

When the switch (S1) is turned on, this large circuit has a SHORT CIRCUIT path (as shown by the arrows). The short circuit prevents any other portions of the circuit from ever working.

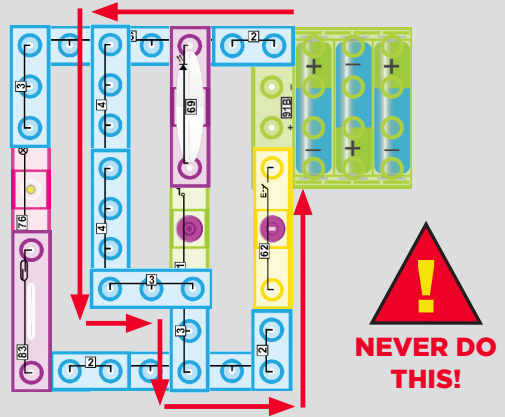

WARNING: SHOCK HAZARD! Never connect E-Blox® Circuit Blox™ to the electrical outlets in your home in any way!

Advanced Troubleshooting (adult supervision recommended)

E-Blox® is not responsible for parts damaged due to incorrect wiring.

If you suspect you have damaged parts, you can follow this procedure to systematically determine which ones need replacing:

- 1. Lamp (76), LED (69), Colorful LED (72):** Place part directly across the battery holder as shown; it should light. Make sure the LEDs are installed in the correct direction. If they do not light, then replace your batteries and repeat. If they still fail to light, then the battery holder is damaged.

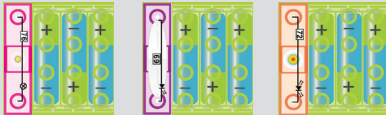

- 2. Bi-directional LED (71):** Place the LED across the battery holder; it should light in both directions.



- 3. Motor (95):** Place the motor across the battery holder (95 at top) as shown; it should spin clockwise.

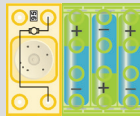

- 4. Switch (62), Press switch (61), Reed Switch (83):** Use the circuit below to test each switch. The lamp (76) should light. If the lamp doesn't light, then the switch is bad.

Switch - Up position the lamp off, Down position lamp on.

Press - Light when switch is pressed.

Reed - When you place the magnet on the switch the lamp should light.

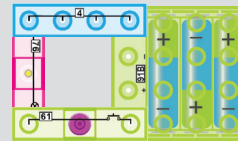

E-Blox®

1574 Barclay Blvd., Buffalo Grove, IL 60089 U.S.A.

Phone / Fax: (855) MY EBLOX (693-2569)

e-mail: help@myeblox.com • Website: www.myeblox.com

**You may order additional / replacement parts at:
www.pickabrick.com**

Project Listings

#	Description	Page	#	Description	Page
1.	Closed Circuit	16	31.	Inertia	31
2.	The 'Momentary' Switch	16	32.	Motor and Alarm in Series.....	31
3.	LED, the Check Valve Light	17	33.	Ohm's Law	32
4.	Magnetic Switch	17	34.	Visual & Audio Alarm	32
5.	Press Switch-controlled Lamp	18	35.	Reed Switch	33
6.	Alarm Switches	18	36.	Newton's Second Law of Motion.....	33
7.	The Bi-directional LED	19	37.	Reed Switch Motor	34
8.	Bi-directional LED Sensor.....	19	38.	Reed Switch vs. Mechanical Switch	34
9.	Proximity Sensor.....	20	39.	Ohm's Law Revisited	34
10.	Fire Drill Alarm	20	40.	Kirchhoff's First Law	35
11.	Personal Security Alarm	21	41.	Kirchhoff's Second Law	35
12.	House Alarm	21	42.	Heart LED.....	36
13.	Fiber Optics.....	22	43.	Morse Code Revisited	36
14.	Fiber Optic Communication	22	44.	Power	37
15.	Colorful Fiber Tree	23	45.	Efficiency	37
16.	Motor Switch	23	46.	Current Limiting Fuse	38
17.	Newton's First Law of Motion.....	24	47.	The Resettable Fuse	38
18.	Magnet-controlled Motor.....	24	48.	Light-Sound Circuit	39
19.	Switches in Series	25	49.	Light-Sound Activation.....	39
20.	Electronic 'AND' Gate	25	50.	Rainbow of Colors	40
21.	Toy Lights	26	51.	Four Switches in Series	40
22.	Ship-to-Ship Morse Code	26	52.	Circuit Breaker.....	41
23.	Reversing a DC Motor	27	53.	Power Outage.....	41
24.	Morse Code Using Fiber	27	54.	Efficiency Revisited	42
25.	Three-person Rocket Launch	28	55.	Battery Power.....	42
26.	Triple Input 'AND' Gate	28	56.	Magnet & Alarm in Series.....	43
27.	Fun Facts About Fiber Optics.....	29	57.	ON-OFF Switch	43
28.	Red and Blue Light	29	58.	Press Switch	44
29.	Sound Waves	30	59.	Angular Light Intensity.....	45
30.	Motors and Magnetic Fields	30			

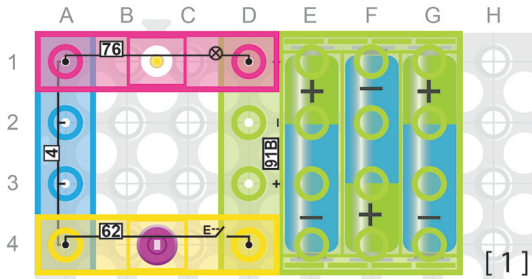

1. Closed Circuit

E-Blox® Circuit Blox™ uses electronic blocks that plug into a clear plastic grid to build different circuits. These blocks have different colors and numbers on them so that you can easily identify them.

Build the circuit shown on the left by placing all the parts that plug into the first layer base. Then, assemble the parts that connect to the secondary layer. Install three (3) “AA” batteries (not included) into the battery holder (91B). **Secure the battery cover before using it.**

Pressing the switch (62) creates a closed circuit; the lamp (76) will turn ON. Press it again to open the circuit and the lamp (76) will turn OFF.

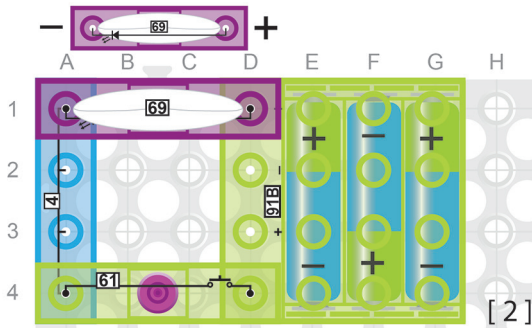

2. The ‘Momentary’ Switch

Build the circuit, press and hold the press switch (61) and the LED (69) will turn ON. Release the press switch (61) and the LED (69) will turn OFF. This type of switch is called a ‘momentary’ switch since it is only ON when pressed.

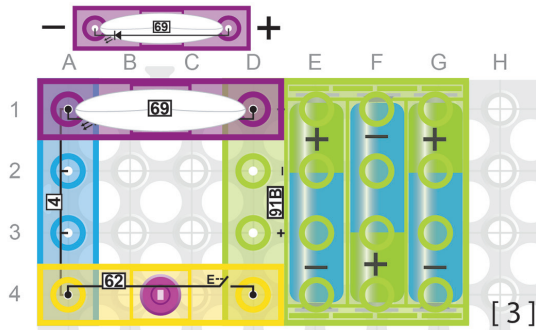

3. LED, the Check Valve Light

Build the circuit to the left making sure the LED (69) is in the correct direction. Press the switch (62) to turn it ON and OFF. Reverse the LED (69) and repeat. Notice that the LED does not light when in the circuit in the reverse direction, demonstrating how LEDs only allow current to flow in one direction.

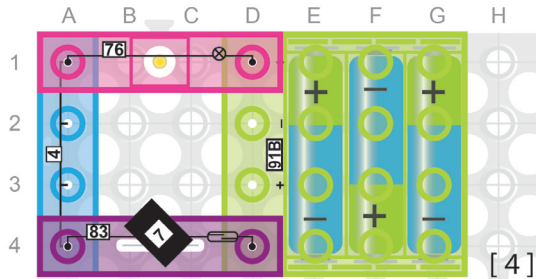

4. Magnetic Switch

Build the circuit on the left. Put the magnet (7) near the reed switch (83) and the lamp (76) will turn ON. Move the magnet (7) away, and the lamp (76) will turn OFF. This is a “no touch” switch!

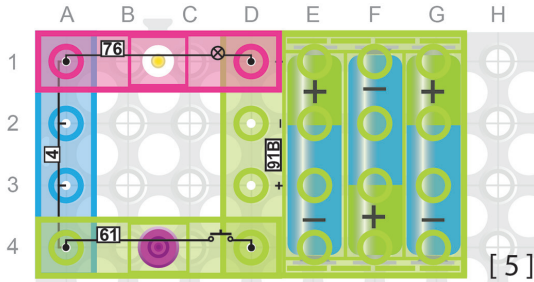

5. Press Switch-controlled Lamp

Build the circuit, press the press switch (61), the lamp (76) will flash. Hold the press switch (61), the lamp (76) will stay on. This circuit acts like a push button flash light.

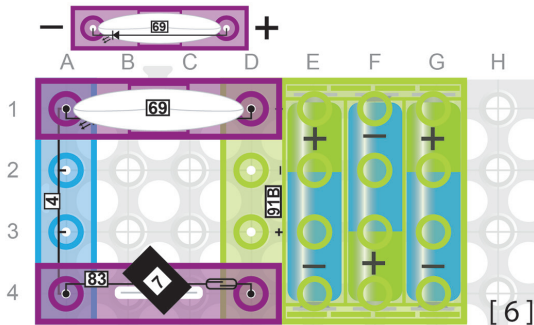

6. Alarm Switches

Build the circuit, making sure the LED (69) is in the correct direction. Move the magnet (7) towards the reed switch (83) and the LED (69) will turn ON. Move the magnet (7) away and the LED (69) will turn OFF. House alarms sometimes use reed switches to detect when a door or window is open.

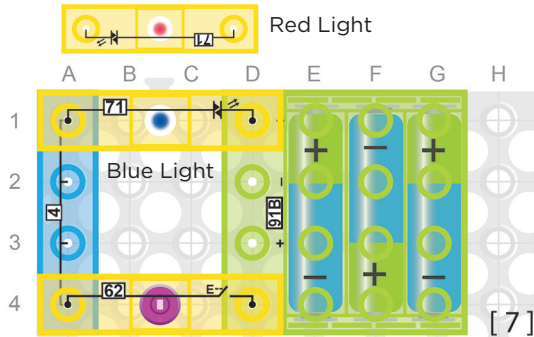

7. The Bi-directional LED

Build the circuit, press the switch (62), you will see the bi-directional LED (71) turn on blue. Install the bi-directional LED (71) in the reverse direction. When you press the switch (62) the bi-directional LED (71) will turn on red. Bi-directional LEDs actually have two diodes in them in opposite directions so current can flow in both directions. But current is only flowing through one diode at a time, which determines which color LED lights.

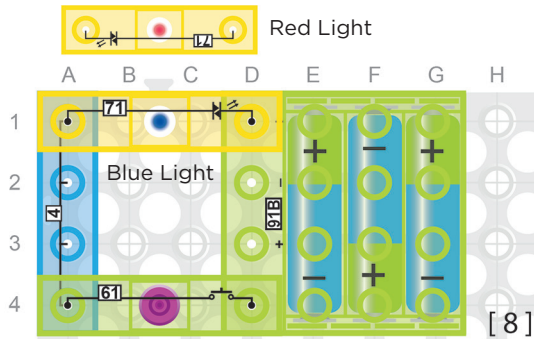

8. Bi-directional LED Sensor

Build the circuit, press the press switch (61) and the bi-directional LED (71) will flash. If you hold press switch (61), the bi-directional LED (71) will turn on blue. Install the bi-directional LED (71) in the reverse direction, then hold the press switch (61) and you will see the bi-directional LED (71) turn on red. Bi-directional LEDs can be used as sensors that indicate which direction current is flowing.

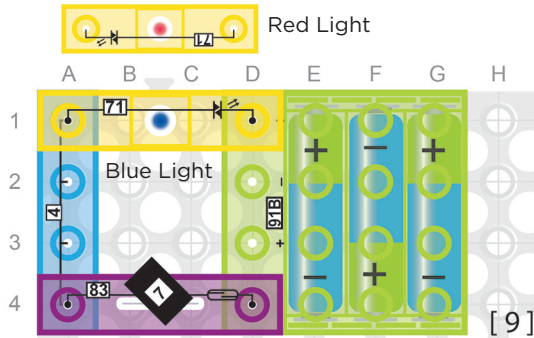

9. Proximity Sensor

Build the circuit, move the magnet (7) towards the red switch (83) and the bi-directional LED (71) will turn on blue.

Move the magnet (7) away and the light will turn off. Install the bi-directional LED (71) in the reverse direction, then move the magnet (7) towards the reed switch (83) and the bi-directional LED (71) will turn on red. Proximity sensing like this is often used to control lights in a room that come on when people enter and go off when the last person exits.

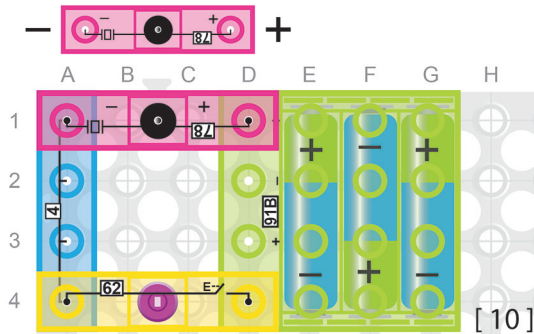

10. Fire Drill Alarm

Build the circuit to the left making sure the alarm (78) is in the correct direction. Press the switch (62) and you will hear the alarm (78). This type of circuit could be used for fire drill tests where a switch is turned ON to set off the fire alarm for the fire drill and then turned OFF when the fire drill is over.

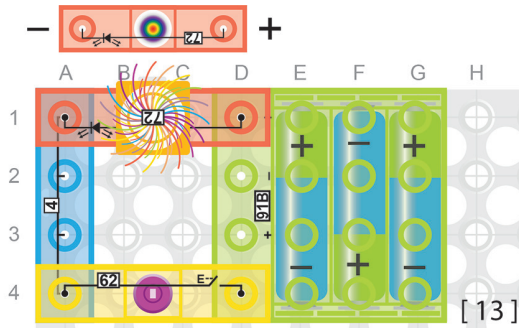

13. Fiber Optics

Build the circuit and place the fiber optic tree on the colorful LED (72). Press the switch (62), the colorful LED (72) will turn on and you will see the fiber optic tree (40) change colors with the LED's colors.

If you look at the tips of the fibers at the top of the tree you will see bright light emitting from the fibers. This demonstrates how fibers carry light, and the simplest form of fibers (called single mode fibers) can actually carry light over 60 miles or more.

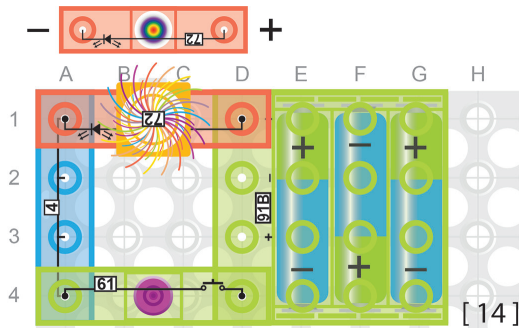

14. Fiber Optic Communication

Build the circuit, press the press switch (61), the colorful LED (72) will flash. Hold the press switch (61), the colorful LED (72) will stay on while the fiber optic tree (40) changes colors with the colorful LED (72). By pressing the press switch (61) ON and OFF for different periods of time you can simulate a digital communication signal (light ON means a digital 1 was sent while light OFF means a digital 0 was sent).

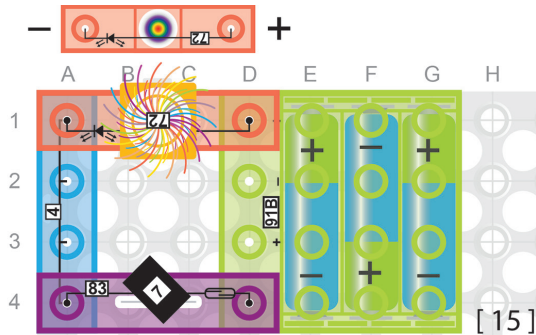

15. Colorful Fiber Tree

Build the circuit, move the magnet (7) towards the reed switch (83), the colorful LED (72) will turn on and the fiber optic tree (40) changes colors with the colorful LED (72). The colorful LED (72) is made of three LEDs (one Red, one Green and one Blue) connected to a tiny Integrated Circuit (IC) that varies the percentage of time each LED is "ON". For instance, the colorful LED (72) will look Red if the Red LED inside is ON 100% of the time and the Green and Blue LEDs are OFF 100% of the time. But if both Red and Green are on 100% of the time and the Blue LED is OFF 100% of the time, then the Colorful LED (72) will look Yellow. Similarly, Red & Blue ON will look Magenta (purple) and Green & Blue ON will look Cyan (light blue). In between colors can be formed by adjusting the percentage of time each LED is on between 0-100%.

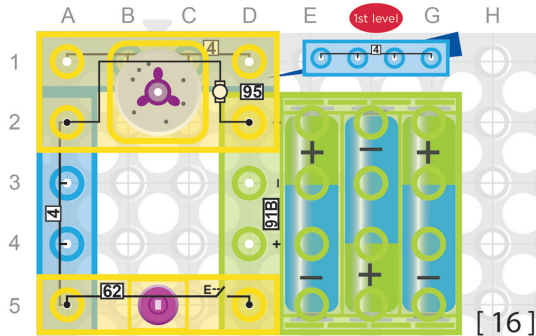

16. Motor Switch

Build the circuit, press the switch (62) and the motor (95) will turn on. Electrical energy from the batteries (91B) has been changed to mechanical energy by the motor (95).



WARNING: Moving parts. Do not touch the motor during operation. Do not lean over the motor.

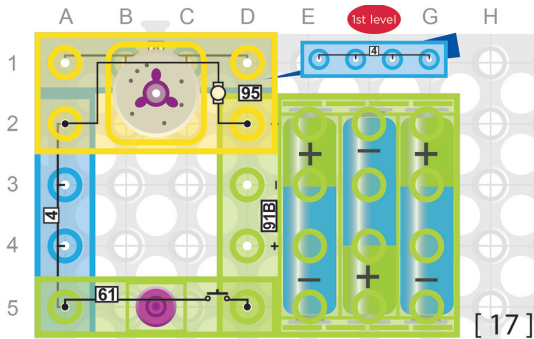

17. Newton's First Law of Motion

Build the circuit on the left; press and hold the press switch (61) and the motor (95) will start spinning. Release the press switch (61), the motor will slow down and finally stop due to friction within it. This demonstrates Newton's First Law of Motion: An object either remains at rest or continues to move at a constant velocity, unless acted upon by a force.

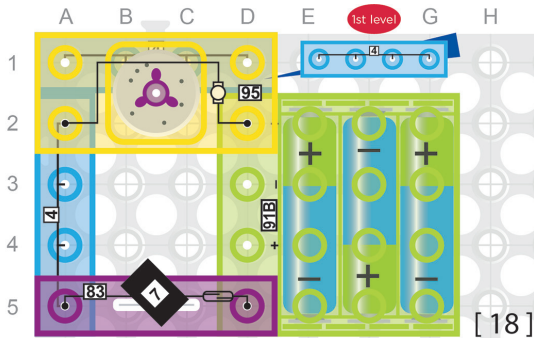

18. Magnet-controlled Motor

Build the circuit, move the magnet (7) towards the reed switch (83) and the motor (95) will turn on. Move the magnet (7) away and the motor (95) will turn off. A reed switch is typically made from two or more ferrous reeds (thin strips) encased within a small glass tube-like envelope, which become magnetized and move together or separate when a magnetic field is moved towards the switch.



WARNING: Moving parts. Do not touch the motor during operation. Do not lean over the motor.

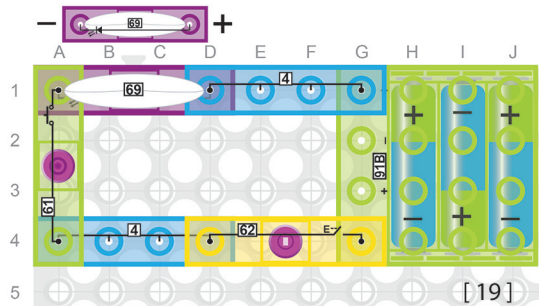

19. Switches in Series

Build the circuit, press the switch (62), then hold the press switch (61). The LED (69) will turn on. Release the press switch (61), then the light will turn off. This kind of circuit could be used in a hotel room where your key card must be inserted in a card holder near the door to enable a closed circuit, but you still need to turn on switches in the room to close the circuit and turn on lights or devices in the room.

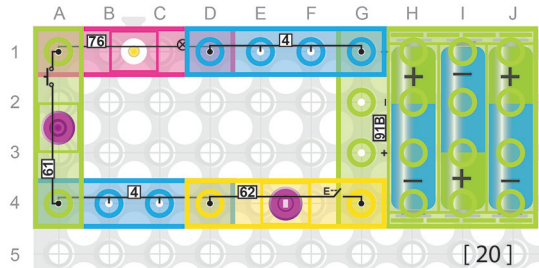

20. Electronic 'AND' Gate

Build the circuit to the left. Note that the lamp (76) only turns on when both the switch (62) and press switch (61) are ON. In digital electronics there are seven logic gates: AND, OR, XOR, NOT, NAND, NOR, and XNOR. This circuit represents an AND gate. If ON = True and OFF = False then an AND gate is best defined as: The output is TRUE only when both inputs are True. Therefore, the two inputs represented by the press switch (61) and the switch (62) must both be ON (TRUE) in order for the output represented by the lamp (76) to be ON (TRUE).

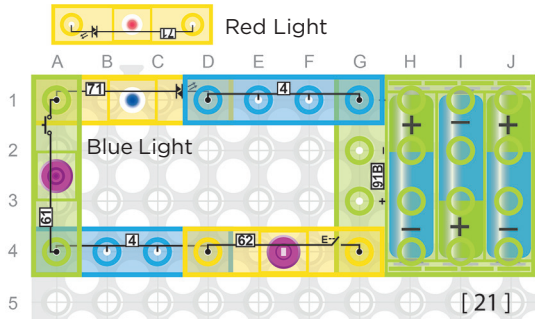

21. Toy Lights

Build the circuit, press the switch (62), then hold the press switch (61), the bi-directional LED (71) will turn on blue. Release the press switch (61), then install the bi-directional LED (71) in the reverse direction, hold the press switch (61) the bi-directional LED (71) will turn on red. Circuits like this are used in lots of battery operated toys where there is a main ON-OFF switch, but also other buttons on the toy that can turn on lights when you press them and the main switch is ON.

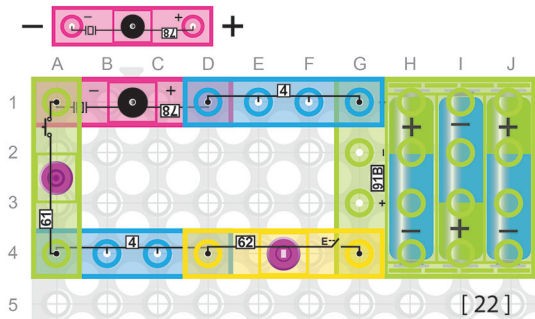

22. Ship-to-Ship Morse Code

Build the circuit, press the switch (62), then hold the press switch (61), you will hear the alarm (78). Release the press switch (61), the alarm (78) will stop. This can be used as a Morse code typing simulator. Morse code uses various sequences of long and short on-off tones, lights or clicks to represent letters, numbers, and text. Since World War II, the process for sending messages using signal lamps has barely changed. It requires someone trained in Morse code to operate the lamp's shutter by hand, receiving, decoding, and replying to messages.

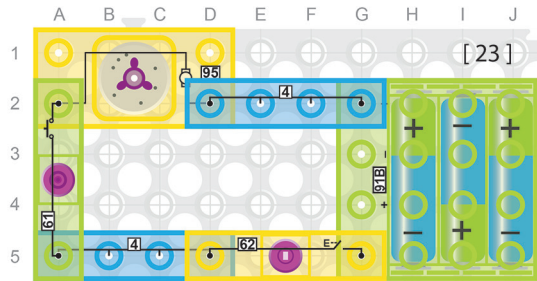

23. Reversing a DC Motor

Build the circuit to the left. Press and hold the press switch (61) and the motor (95) will spin clockwise. Release the press switch (61) and the motor (95) will stop. Now put the motor (95) in backwards reversing its direction (95 should be upside down now) and swapping it with the 4-wire in grid locations D2 through G2. Press and hold the press switch (61) and the motor (95) now spins counterclockwise. Notice that the direction the motor (95) spins is related to the direction the current flows through the motor (95). This is because the force created on the motor shaft is related to the direction that the current flows through the magnetic field in the motor (95). You can look up Fleming's left hand rule for more details on how the relationship between the current flow, magnetic field and force that creates motion.

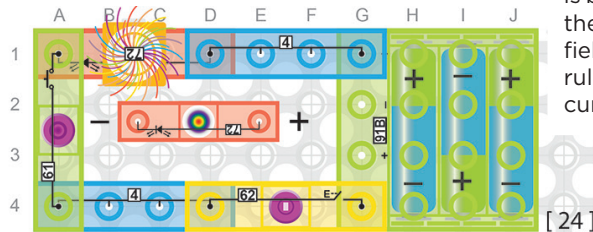

WARNING: Moving parts. Do not touch the motor during operation. Do not lean over the motor.

Morse Code

A ●—	J ●— —	S ●●●
B ●●●●	K ●— ●	T —
C —●●●	L ●●●●	U ●●●
D —●●	M — —	V ●●●—
E ●	N ●—	W ●●—
F ●●●●	O — — —	X ●●●—
G —●—	P ●●●—	Y ●—●—
H ●●●●●	Q —●—●	Z —●—●
I ●●	R ●—●	

24. Morse Code Using Fiber

Build the circuit above, press the switch (62), then hold the press switch (61). The colorful LED (72) will turn on and the fiber optic tree (40) will light up with the colors of the colorful LED (72). Release the press switch (61); the colorful LED (72) will turn off. The International Morse Code is shown to the left where a dot represents a quick push of the press switch (61) and a dash represents holding the press switch (61) for a second. Try sending letters or a code to a friend and see if they can decode it by looking at how the ends of the fibers flash on and off.

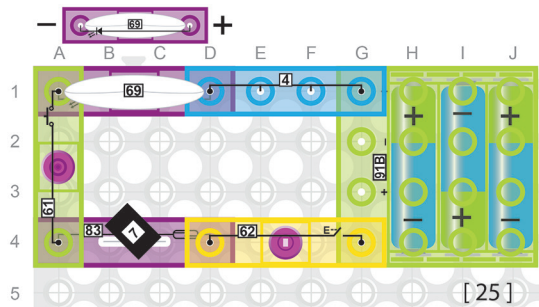

25. Three-person Rocket Launch

Build the circuit to the left. In this circuit, pretend the LED (69) is a rocket. To launch the rocket the switch (62) must be ON, AND the press switch (61) must be ON, AND the reed switch (83) must be turned ON with the magnet (7). Systems like this are used to prevent accidental rocket launching by having the switches placed far enough apart that it requires three people to turn them on simultaneously.

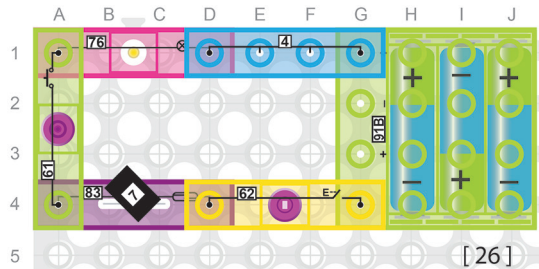

26. Triple Input 'AND' Gate

Build the circuit on the left, turn the switch (62) ON, press and hold the press switch (61) to turn it ON, and move the magnet (7) towards the reed switch (83). Only when all three switches (INPUTS) are ON (True) will the lamp (OUTPUT) be ON (True). Electronic AND Gates can have two or more inputs but the function is still the same. All inputs must be True (ON) for the output to be True (ON).

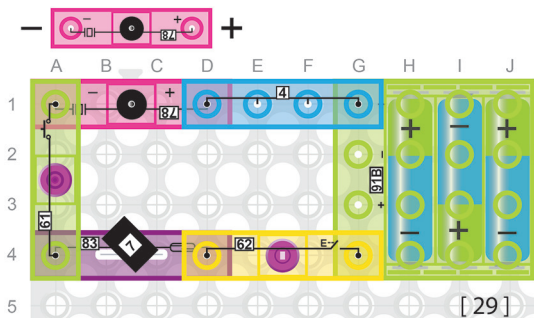

29. Sound Waves

Build the circuit, press the switch (62), then hold the press switch (61). When you move the magnet (7) towards the reed switch (83), you will hear the alarm (78). If you move the magnet (7) away, the alarm (78) will turn off. The alarm (78) makes sound by creating sound waves, much like light waves, but at much longer wavelengths and much lower frequencies. Frequency is the inverse of wavelength ($\text{Frequency} = 1 \div \text{Wavelength}$) and is measured in Hertz (Hz). The human ear can hear sound waves between about 20 Hz and 20 kHz (20,000 Hz).

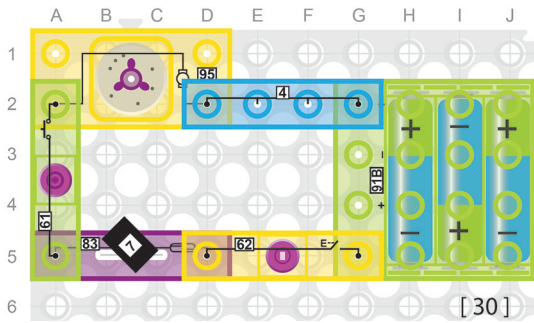

30. Motors and Magnetic Fields

Build the circuit, press the switch (62), then hold the press switch (61). When you move the magnet (7) towards the reed switch (83), you will see the motor (95) turn on. If you move the magnet (7) away, the motor (95) will turn off. Now put the magnet (7) near the motor (95). Note that the magnet (7) is attracted to the motor (95) at certain locations. This is because motors have magnets inside them that create a magnetic field. When a current flows through this magnetic field (the circuit is ON), it creates a force (look up Fleming's rule) that spins the motor shaft.

WARNING: Moving parts. Do not touch the motor during operation. Do not lean over the motor.

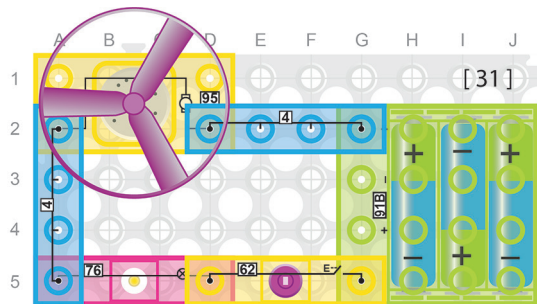

WARNING: Moving parts. Do not touch the fan or motor during operation. Do not lean over the motor.

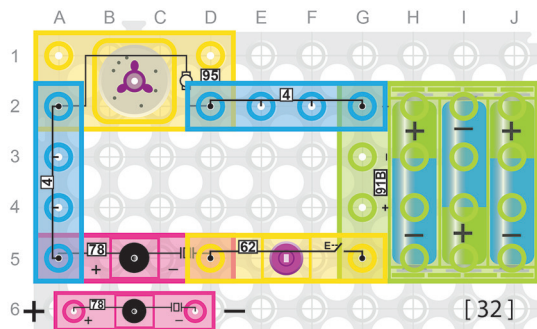

31. Inertia

Build the circuit, press the switch (62), the fan blade (60) of the motor (95) will start running while the lamp (76) is on. Release the press switch (61) and the fan will keep spinning for a short while, but the lamp (76) will turn off immediately. This circuit demonstrates the concept of Inertia: a property of matter by which it continues in its existing state of rest or uniform motion in a straight line, unless that state is changed by an external force. The fan has inertia, but the lamp does not.

Fan Assembly

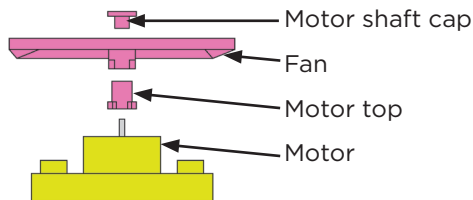

32. Motor and Alarm in Series

Build the circuit, press the switch (62) and you will hear the alarm (78) faintly. The motor (95) will be off. Because the motor (95) and the alarm (78) are in series, and thus see the same current, the resistance in the alarm (78) limits the current through the motor (95) preventing it from spinning.

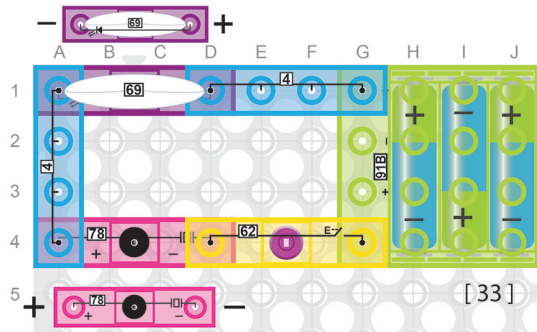

33. Ohm's Law

Build the circuit, press the switch (62) and you will hear the alarm (78) while the LED (69) turns on at the same time. Using Ohm's Law the resistance of each part could be calculated. If you had a voltmeter and measured the voltage drop across each component, you would see that the voltage drop across the LED (69) and the alarm (78) are similar (around 2V to 2.5V drop across each). According to Ohm's Law, $R = V \div I$ which means the internal resistance of the LED (69) is similar to the internal resistance of the alarm (78). However, the LED (69) is dim and the alarm (78) is softer because they each have lower voltage across them when in series like this circuit. Each part is designed using Ohm's Law to perform best when they have full battery voltage.

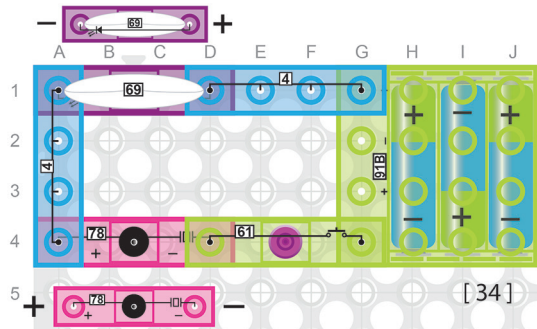

34. Visual & Audio Alarm

Build the circuit, press the press switch (61) several times, the alarm (78) will sound for short intervals. If you hold the press switch (61), the alarm (78) will start while the LED (69) is on. This type of circuit could be used to provide both an audio alarm and a visual alarm in case the room was too loud to hear the audio alarm.

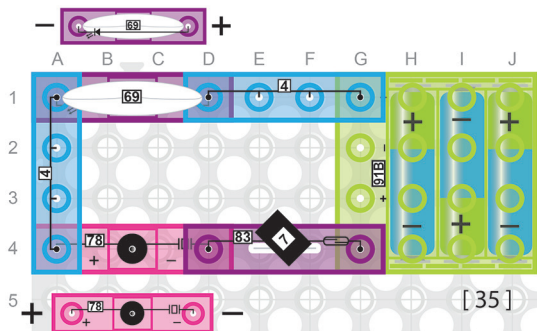

35. Reed Switch

Build the circuit, move the magnet (7) towards the reed switch (83), the alarm (78) will sound while the LED (69) is on. Move the magnet (7) away, the alarm (78) and LED (69) will turn off.

Reed switch circuits like this can be used to detect fluid levels for coffee makers, dish washers, washing machines and water heaters. By putting a magnet on a float, which rises and falls with the liquid in the container, the magnet can trigger a reed switch circuit that sets off an alarm and lights whenever the liquid, and by extension, the magnet, reach a certain level.

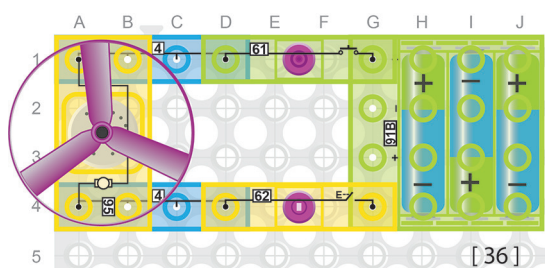

36. Newton's Second Law of Motion

Build the circuit, press the switch (62), then hold the press switch (61). The fan blade (60) of the motor (95) will spin. Release the press switch (61), the fan blade (60) will launch into the air. (Caution! Never let it fly near your face!)

Reminder: Remove the shaft cap before using the flying saucer.

If the fan does not fly, make sure the batteries are fresh, the motor (95) is in the correct direction, and give the fan a tap from underneath with the top of your fingernail. This circuit demonstrates Newton's Second Law of Motion: acceleration is produced when a force acts on a mass. In this case, air pressure under the fan blade forces it to rise.



WARNING: Moving parts. Do not touch the fan or motor during operation. Do not lean over the motor.

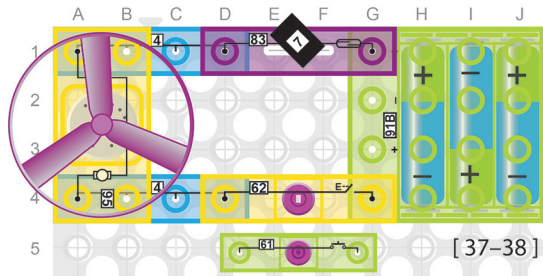

WARNING: Moving parts. Do not touch the fan or motor during operation. Do not lean over the motor.

37. Reed Switch Motor

Build the circuit, press the switch (62), when you move the magnet (7) towards the reed switch (83), you will see the fan blade (60) of the motor (95) start spinning. When you move the magnet (7) away, the fan blade (60) will stop spinning. Reed switches can actually be used to create what are called brushless motors.

38. Reed Switch vs. Mechanical Switch

Build the circuit by replacing the switch (62) with the press switch (61). Press and hold the press switch (61). When you move the magnet (7) towards the reed switch (83), you will see the fan blade (60) of the motor (95) start spinning. When you move the magnet (7) away, the fan blade (60) will stop spinning. One of the benefits of reed switches over mechanical switches like the press switch (61) is reliability/lifetime. Mechanical switches can wear out more quickly as you use them, and some studies show that reed switches can be used 10,000 times more often than mechanical switches before they wear out.

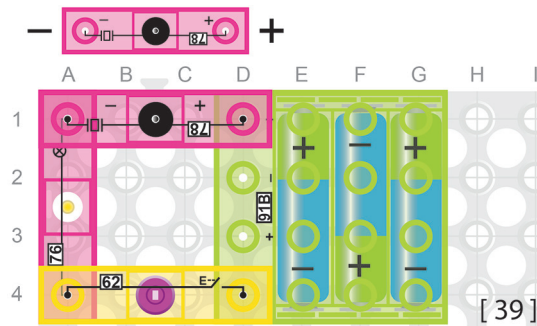

39. Ohm's Law Revisited

Build the circuit, press the switch (62). You will hear the alarm (78) start wailing while the lamp (76) will light dimly. You may need to be in a dark room to see the dim light from the lamp (76). There is more resistance in the alarm (78) than in the lamp (76) which means the voltage across the lamp (76) is much less than the voltage across the alarm (78), which is why the lamp (76) is dim.

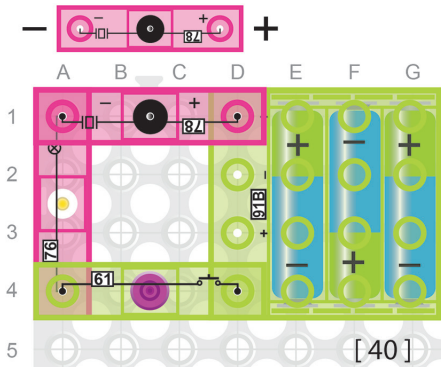

40. Kirchhoff's First Law

Build the circuit, press and hold the press switch (61), you will hear the alarm (78) sound, while the lamp (76) will light dimly. When you release the press switch (61), the alarm (78) will stop. The lamp is used as a wire block in this circuit and will light dimly. Kirchhoff's first law states: At any node (junction) in an electrical circuit, the sum of currents flowing into that node is equal to the sum of currents flowing out of that node. Location A1 represents a node. If a positive current is coming into a node and a negative current is leaving a node, then:

$$I_{\text{alarm}} + I_{\text{lamp\&press switch}} = 0 \quad \text{or} \quad I_{\text{alarm}} = -I_{\text{lamp\&press switch}}$$

This shows that the current through the alarm and the lamp are the same in this series circuit, but one is flowing into node A1 and one is flowing out of node A1.

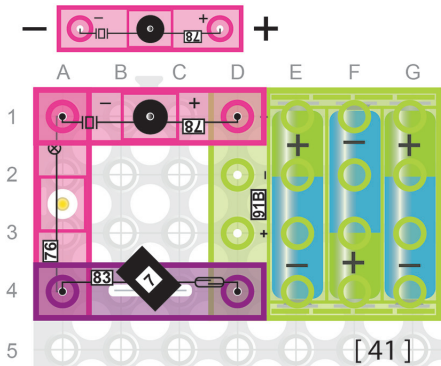

41. Kirchhoff's Second Law

Build the circuit, move the magnet (7) towards the reed switch (83), the alarm (78) will start while the lamp (76) will light dimly. When you move the magnet (7) away the alarm (78) will stop. Kirchhoff's second law states: The sum of the voltages around a closed network is zero. If a drop in voltage is considered as a negative voltage and a rise in voltage a positive voltage, then the following equation is a mathematical representation of Kirchhoff's second law:

$$V_{D1 \rightarrow A1} + V_{A1 \rightarrow A4} + V_{A4 \rightarrow D4} + V_{D4 \rightarrow A4} = 0$$

This shows that the voltage drop across the battery module (91B) must equal the voltage drop across the alarm (78) plus the voltage drop across the lamp (76) plus the voltage drop across the reed switch (83).

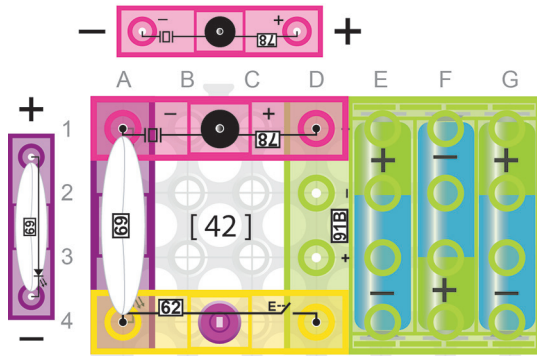

42. Heart LED

Build the circuit, press the switch (62), the alarm (78) will start in a low volume, while the LED (69) turns on. Reverse the the direction of the LED (69) and the heart will not light and the alarm will not sound. LEDs stand for Light Emitting Diodes, and diodes are made of semiconductor material that only allows significant current to flow in one direction.

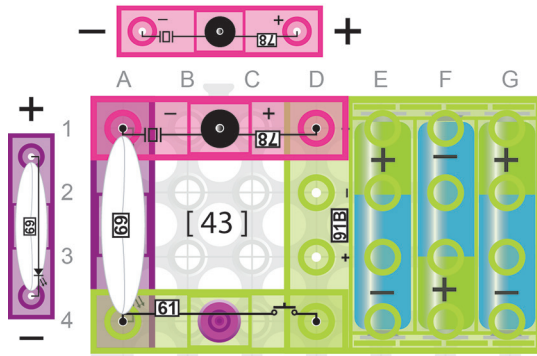

43. Morse Code Revisited

Build the circuit, hold the press switch (61), the alarm (78) will start in a low volume, while the LED (69) turns on. Release the press switch (61), then the alarm (78) and the LED (69) will turn off at the same time.

Try tapping in the Morse code below. This stands for S.O.S, or Save Our Souls. If you ever hear this sound then it means someone is in danger and calling for help.



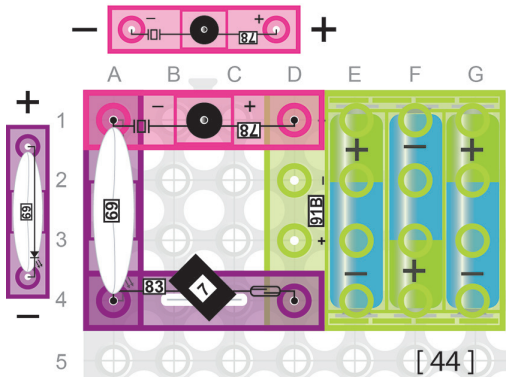

44. Power

Build the circuit, move the magnet (7) towards the reed switch (83), the alarm (78) will start in a low volume while the LED (69) turns on. If you move the magnet (7) away, the alarm (78) and LED (69) will turn off. Power is defined as voltage times current and is measured in Watts. In Project 33 we saw that the voltage drops across the LED (69) and alarm (78) in series were similar, and since the current through both components is the same, this means the power input to each component is roughly the same.

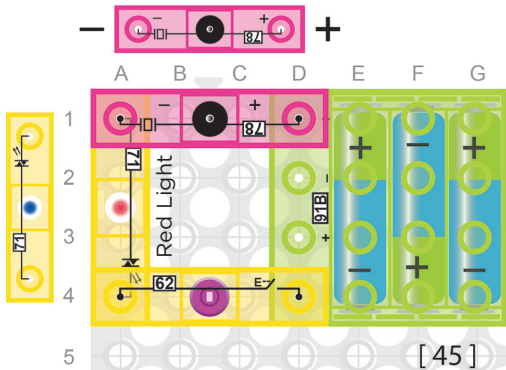

45. Efficiency

Build the circuit, press the switch (62), the alarm (78) will sound, the bi-directional LED (71) turns on red. Install the bi-directional LED (71) in the reverse direction, then press the switch (62), the bi-directional LED (71) will turn on blue and the alarm will sound very faintly.

Electronic Efficiency is defined as the Useful Power Output divided by the Total Power Input. Although the alarm (78) sound was softer, the LED (71) is still pretty bright. This shows that the LED (71) is a little more efficient because for the same input power (as discussed in the previous project) the output power (the light intensity) is still high.

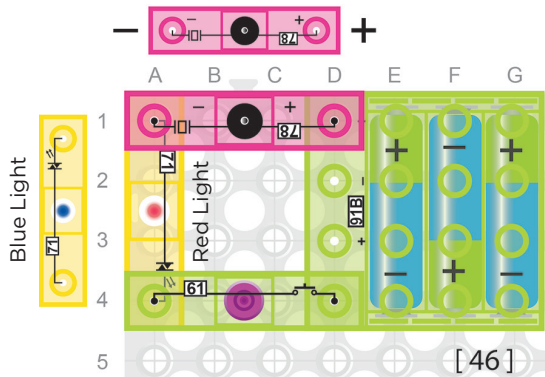

46. Current Limiting Fuse

Build the circuit, hold the press switch (61), you will hear the alarm (78) sound, while the bi-directional LED (71) turns on red. Release the press switch (61), then install the bi-directional LED (71) in the reverse direction. Hold the press switch (61), you will see the bi-directional LED (71) will turn on blue and the alarm will sound very faintly. If you release the press switch (61), the alarm (78) and the bi-directional LED (71) will turn off. In this circuit the LED (71) is acting like a current limiting fuse by limiting the current to the alarm (78). Replace the LED (71) with a 4-wire (4) and the alarm (78) will now be much louder. Current limiting fuses are used to provide over-current protection in electronic distribution systems.

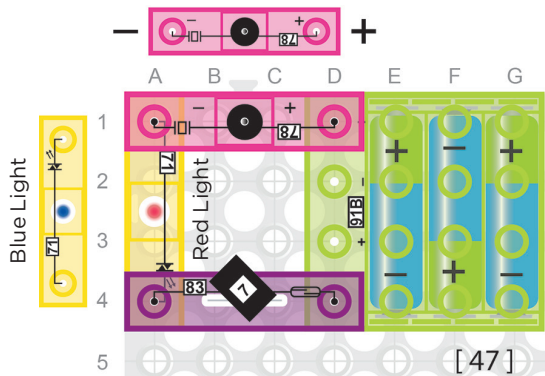

47. The Resettable Fuse

Build the circuit, move the magnet (7) towards the reed switch (83), the alarm (78) will sound while the bi-directional LED (71) turns on red. Move the magnet (7), then install the bi-directional LED (71) in the reverse direction. Now if you move the magnet (7) towards the reed switch (83), the bi-directional LED (71) will turn on blue and the alarm will sound very faintly. If you move the magnet (7) away, you will see the alarm (78) and bi-directional LED (71) turn off. Positive-Temperature-Coefficient, or PTC, thermistors – also known as resettable fuses are devices that have very low resistance until a current is reached, then they get warm and the resistance changes limit the current. Pretend the magnet (7) is a piece of ice and the reed switch acts like a PTC fuse. Putting the magnet (7) near the reed switch cools down the PTC fuse allowing the LED (71) to light and alarm (78) to sound. Taking away the magnet (7) makes the PTC fuse (the reed switch) heat up, which shuts off the circuit.

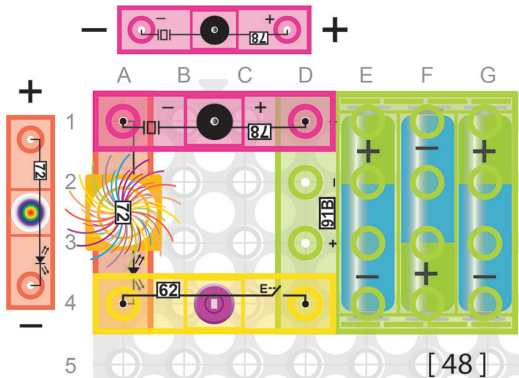

48. Light-Sound Circuit

Build the circuit, press the switch (62), the alarm (78) will sound very faintly. Then you will see the colorful LED (72) turn on. The fiber optic tree (40) will be lit up with the colors of the LED. Circuits like this are used a lot in toys that light up and make sounds when you turn them on.

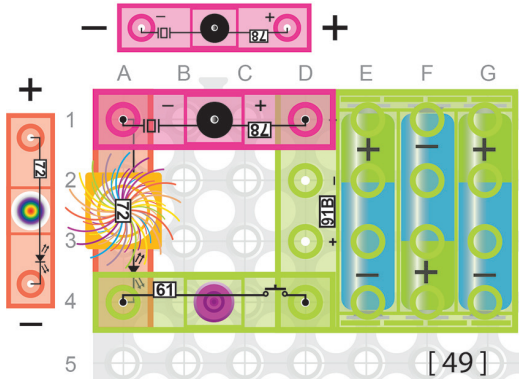

49. Light-Sound Activation

Build the circuit, press and hold the press switch (61), the alarm (78) will sound very faintly. Then you will see the colorful LED (72) turn on with the light of the fiber optic tree (40) on with the colors of the LED.

Circuits like this are used a lot in toys that light up and make sounds when you press a button.

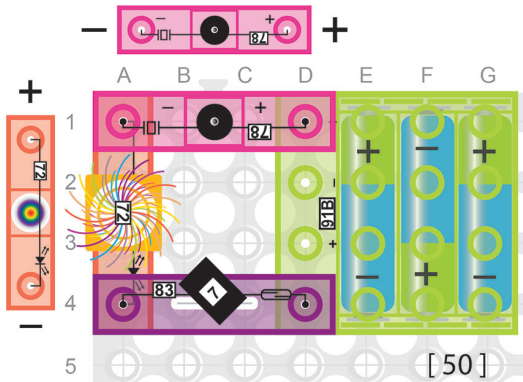

50. Rainbow of Colors

Build the circuit, move the magnet (7) towards the reed switch (83), and the alarm (78) will sound very faintly. Then you will see the fiber optic tree (40) turn on with the light of the colorful LED (72). If you move the magnet (7) away the alarm (78), the colorful LED (72) will turn off.

The colorful LED (72) cycles through a rainbow of colors. A rainbow is a meteorological phenomenon that is caused by reflection, refraction, and dispersion of light in water droplets resulting in a spectrum of light appearing in the sky. It takes the form of a multicolored circular arc.

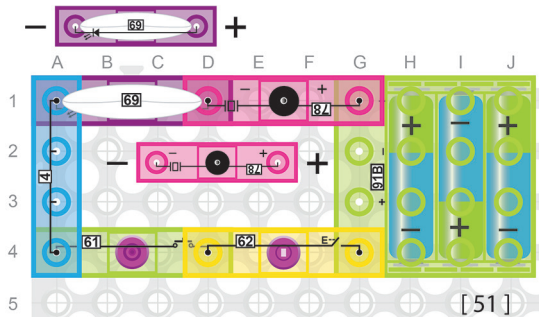

51. Four Switches in Series

Build the circuit, press the switch (62), then hold the press switch (61); you will hear the alarm (78) start with its pitch varying from low to high, also the LED (69) will turn on. Release the press switch (61), the alarm (78) and LED (69) will turn off. You can think of this circuit as four switches in series because the press switch (61) and switch (62) have to both be ON and the LED (69) and alarm (78) both have to be in the circuit in the correct direction for the circuit to be closed.

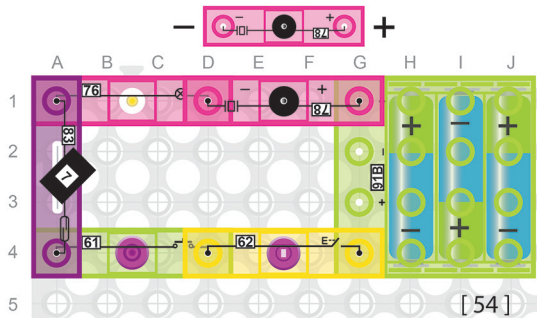

54. Efficiency Revisited

Build the circuit, press the switch (62), then hold the press switch (61). Move the magnet (7) towards the reed switch (83) and you will hear the alarm (78) sound while the lamp (76) is still off. If you release the press switch (61) or move the magnet (7), the alarm (78) will turn off. This circuit shows that the lamp (76) is not very efficient because even though current is flowing through the lamp (76), meaning there is input power, it does not light, meaning no output power.

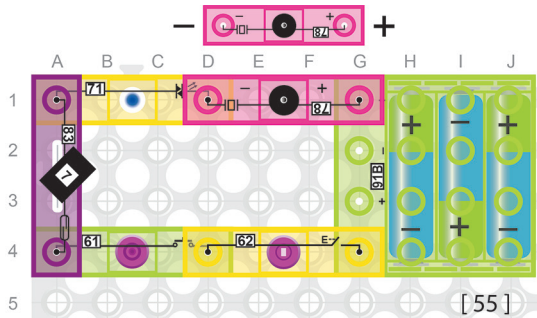

55. Battery Power

Build the circuit, press the switch (62), then hold the press switch (61). Move the magnet (7) towards the reed switch (83) and you will hear the alarm (78) sound very faintly while the bi-directional LED (71) turns on blue. If you release the press switch (61), or move the magnet (7) away, the alarm (78) and bi-directional LED (71) will turn off.

Batteries have a cathode (+ side) and anode (- side) and are designed to have a build up of electrons in the anode. When you turn on all the switches in this circuit, it closes the circuit which allows the build up of electrons to flow out of the anode enabling current to flow through the circuit.

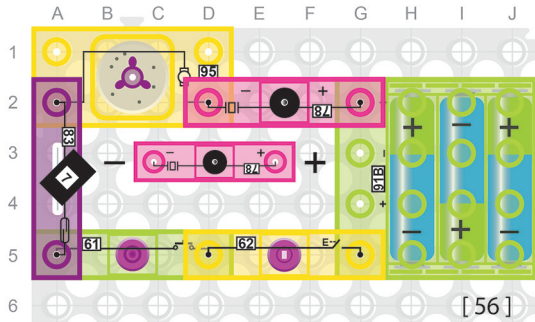

56. Magnet & Alarm in Series

Build the circuit, press the switch (61), then hold the press switch (61). Move the magnet (7) towards the reed switch (83) and you will hear the alarm (78) sound very faintly while the motor (95) is off. If you release the press switch (61), or move the magnet (7) away, the alarm (78) and motor (95) will turn off. The resistance in the alarm (78) limits the current in this series circuit, which is why the motor does not spin.

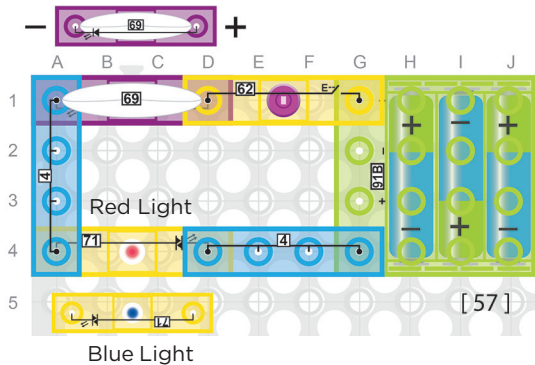

57. ON-OFF Switch

Build the circuit, press the switch (62), and you will see the LED (69) and the bi-directional LED (71) turn on at the same time. If you install the bi-directional LED (71) in the reverse direction, then press the switch (62), the LED (69) will turn on red while the bi-directional LED (71) will turn on blue.

The switch (62) is commonly called an on/off switch since it just turns the circuit on or off from one location. For that reason, it's also referred to as single location switch. Inside an on/off switch, there's a spring-loaded gate. When you change the switch to ON, that gate snaps closed. It closes the circuit and lets the power flow through the switch. When you change it to OFF, the gate snaps open. It opens the circuit and interrupts the flow of current, making power consumption zero.

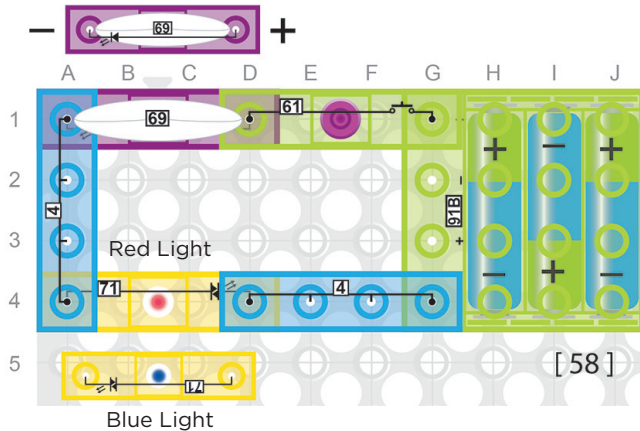

58. Press Switch

Build the circuit, press and hold the press switch (61), and you will see the LED (69) and the bi-directional LED (71) turn on red at the same time. Install the bi-directional LED (71) in the reverse direction, then press the press switch (61); the LED (69) will turn on red while the bi-directional LED (71) will turn on blue.

The press switch (61) is a momentary or non-latching switch which temporarily closes the electrical circuit only while the switch is physically actuated. An automatic mechanism (i.e. a spring) returns the switch to its default position immediately afterwards, opening the circuit. This type of switch is also sometimes called a “push to make” switch or a normally open (NO) Switch. Example usages are doorbells, computer case power switches, and calculator buttons.

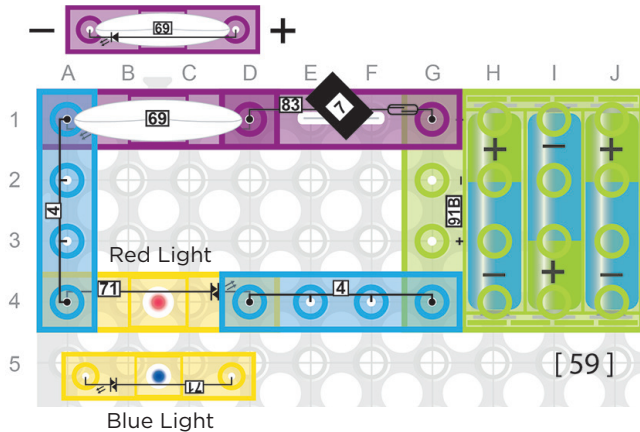

59. Angular Light Intensity

Build the circuit, move the magnet (7) towards the reed switch (83), and you will see the LED (69) and the bi-directional LED (71) turn on red. Move the magnet (7) away and install the bi-directional LED (71) in the reverse direction. Move the magnet (7) towards the reed switch (83) and you will see the LED (69) turn on red and the bi-directional LED (71) turn on blue.

While it may appear that the bi-directional LED (71) is brighter than the heart LED (69), this is because LEDs have angular light intensity profiles such that a majority of the light emits straight out of the top of the LED. If you look from the side at the bi-directional LED (71) you will see it looks very dim, just like looking at the side of the heart LED (69).

Other E-Blox® Products

More sets available! Visit www.myeblox.com



Burp 'N Fart Machine

10 hilarious sounds, including burp and fart sounds that are so real, you'll be holding your nose! 6 pieces, including a speaker, sound module, and more!



Fan Launch Challenge

How steady is your hand? Try to follow the maze with the hook without launching the fan. 8 pieces, including a motor, fan, maze, and more!



Bubble Making Machine

This build your own Bubble Making Machine comes with all the parts and bubble solution needed to build a circuit that creates a continuous stream of bubbles!



Lights 'N Motion

Create flashing structures that spin! LED blox work in any direction! 25 pieces, including 16 color-changing and 4 white LED blox, slow motor, and gear.



Other E-Blox® Products

More sets available! Visit www.myeblox.com



Sound Activated Dancing Lights

32 pieces, including a voice/sound activated 10-LED color-changing module, four transparent color plastic spacers, 20 transparent spacers, and more! Perfect for parties!



120 Projects

49 pieces, including a sound module, FM radio module, LEDs, lamp, speaker, motor, 3 fan blades, and more! Includes 72-page, full-color STEM project manual.



395 Projects

66 pieces, including a sound module, FM radio module, LEDs, resistors, capacitors, NPN transistor, motor, 3 fan blades, and more! Includes 154-page, full-color robust STEM project manual with detailed explanations.



800 Projects

78 pieces, including an inductor coil, magnet spinner, resistors, capacitors, NPN & PNP transistors, and more! Includes 148-page, full-color robust STEM project manual with detailed explanations.



Other E-Blox® Products

More sets available! Visit www.myeblox.com



Builder 4-in-1

Builds include Angry Shark, My House, Night Copter, and Scary Insect. Contains 46 parts, including transparent blue blocks and 2 red/green bi-directional LEDs.



Light 'N Flight 5-in-1

Builds include Air Boat, Airplane, Dual Fan Launcher, Fan Shooter, and Helicopter. Contains 58 parts, including a motor, 3 fan blades, and 1 red/blue flashing and 2 white LEDs.



Standard

Contains 45 patented parts, including 10 LEDs. Ideally suited for building LED circuits into your MOCs. Online instructions available for three models. Compatible with other toy brick sets.



Electric Crazy Action Racers 10-in-1

Contains 24 parts, including motor block, wheels & axles, and more! Builds include Airplane, Angle Spinner, Dragster, Fan Car, Handheld Fan, Mobile Fan Launcher, Reclining Racer, Silly Spinner, Spinning Airplane, and Windmill Racer.





**1574 Barclay Blvd.
Buffalo Grove, IL 60089 U.S.A.
Visit us at: www.myeblox.com**

U.S. Patents: 6,805,605 and other patents pending.

Copyright © 2021 E-Blox®, Inc. All rights reserved.
REV-C

Colors and styles may vary.

Made in China