

FCC Part 15 C Notice

CAUTION: Changes or modifications not expressly approved by the party responsible for compliance could void the user's authority to operate the equipment.

NOTE: This equipment has been tested and found to comply with the limits for a Class B digital device, pursuant to Part 15 of the FCC Rules. These limits are designed to provide reasonable protection against harmful interference in a residential installation. This equipment generates, uses and can radiate radio frequency energy and, if not installed and used in accordance with the instructions, may cause harmful interference to radio communications. However, there is no guarantee that interference will not occur in a particular installation. If this equipment does cause harmful interference to radio or television reception, which can be determined by turning the equipment off and on, the user is encouraged to try to correct the interference by one or more of the following measures:

- Reorient or relocate the receiving antenna.
- Increase the separation between the equipment and receiver.
- Connect the equipment into an outlet on a circuit different from that to which the receiver is connected.
- Consult the dealer or experienced radio/TV technician for help.

This device complies with Part 15 of the FCC Rules. Operation is subject to the following two conditions:

- (1) This device may not cause harmful interference, and
- (2) this device must accept any interference received, including interference that may cause undesired operation.

FCC RF exposure statements

This Transmitter must not be co-located or operating in conjunction with any other antenna or transmitter. This equipment complies with FCC RF radiation exposure limits set forth for an uncontrolled environment. This equipment should be installed and operated with a minimum distance of 20 centimeters between the radiator and your body or nearby persons.



Requires Speed Class 10 or higher microSD or microSDHC card(not included)

microSDHC Logo is a trademark of SD-3C, LLC.

Distributed by:
TRACTOR SUPPLY COMPANY
5401 VIRGINIA WAY
BRENTWOOD, TN 37027
For customer support,
call: 1-888-376-9601
www.TractorSupply.com

Conforms to safety requirements of FCC.

Ascend Aeronautics™ is the registered trademark of AMAX Industrial Group LTD.
AMAX Group USA Address: 12645 Memorial Dr Suite F1 #388 Houston, TX 77024
© 2021 All Rights Reserved. Visit us at www.amaxbrands.com

Made in China
C012-USA-V 1.0

ASC-2080

COMPACT HD VIDEO DRONE WITH WIDE ANGLE LENSE



INSTRUCTION BOOKLET

WARNING: Never leave your drone charging unattended for extended periods of time. Always disconnect the battery from charger immediately after the battery is fully charged. Please refer to the enclosed safety instructions.

PACKAGE CONTAINS:

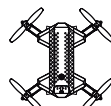

ASC-2080



2.4G Wireless
Controller



Spare Parts



USB Charger



Phone Holder



Battery



Instruction
Manual

Colors and styles may vary slightly from photos

TABLE OF CONTENTS

Features	2
Remote Control Battery Installation	2
Charging the ASC-2080 Li-Poly Battery	2
Installing The ASC-2080 Battery	2
How to Expand and Fold Your ASC-2080 Arms	2
ASC-2080 Diagram	3
Control Diagram	3
Flight Preparation	4
Syncing Your ASC-2080	4
Now You Are Ready To Fly	5
Recognizing The Front & Rear Of The ASC-2080	5
Starting/Stopping The Rotors	5
Automatically Take Off / Land	5
Speed Select Button	5
T (Training) Mode & Obstacle Avoidance Training Feature	5
Flight Control	6
Flight Practice	6
Adjusting The Trim	7
Calibrating The ASC-2080	8
About 360° Stunt Flips	8
Steps To Executing A Stunt Flip	8
Recording Videos And Taking Photos With Your Asc-2080 Drone	9
Installing Your Phone Holder	10
Camera Video And Photo Streaming Setup	11
Troubleshooting Your ASC-2080	12
Replacing The Propeller Blades	13
Blades Guard Installation	13
Warnings	14
Battery Warnings	14
Care and Maintenance	14
Limited 90-Day Warranty	16
FCC Information	17

Thank you for purchasing the ASC-2080 HD Streaming Video Drone. Please read this instruction booklet as it contains valuable information on how to properly fly and care your ASC-2080.

FEATURES

- Compact fold-in design allows for easy portability
- New obstacle avoidance training feature will cause the drone to automatically circumvent walls and other obstructions so new pilots can get the hang of flying
- Air pressure sensor locks flight altitude for stable video footage
- Takes video and still shots with on board HD Camera
- 6 axis gyro for extremely stable flight and maneuverability

REMOTE CONTROL BATTERY INSTALLATION

1. Unscrew and remove the battery cover from the back of the controller.
2. Install 3 fresh "AAA" alkaline batteries into the controller as shown in diagram A. Replace the battery cover and secure it.
3. Turn over the controller and press the power button.
If the power indicator turns on you have installed your batteries properly.

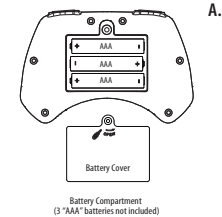

CHARGING THE ASC-2080 LI-POLY BATTERY

1. Connect the USB charger to the battery charging socket (see diagram B).
2. Connect the USB end of the cable to your computers USB port or a USB wall charger (see diagram C).
3. The indicator light on the USB charger will turn to solid red to indicate that the battery is charging. The red LED indicator will turn off when charging is completed.
4. Average charging time is approximately 60-80 minutes (via 5.0V --- 2A USB wall charger).

IMPORTANT: ALWAYS REMEMBER TO UNPLUG YOUR CHARGING CORD WHEN NOT IN USE!

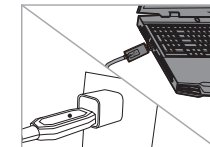
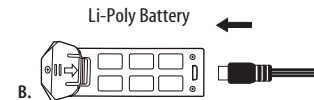

C.

INSTALL THE ASC-2080 BATTERY

Carefully Push the fully charged battery into the ASC-2080 battery compartment all the way in until it stops and is flush with back of the drone (see diagram D).

NOTE: The battery only fits one way into the battery compartment. Never force it.

HOW TO EXPAND AND FOLD YOUR ASC-2080 ARMS

Before flying your ASC-2080, you need to expand the foldable arms out.

1. Make sure the drone power is turned off.
2. Holding the folded ASC-2080 drone in the palm of your hand (see diagram E) proceed to open the arms by starting with the Rear Arms (Lower Arms) and then Front Arms (Upper Arms)
3. Make sure the arms are fully extended and locked into place (see diagram F). Note you will feel some additional pressure indicating the arm is properly locked into place.
4. When folding in the arms simply reverse steps 1-3 above.

NOTE: Never use hard force when opening and closing the ASC-2080 Arms.

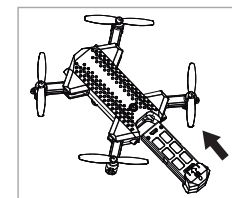

D

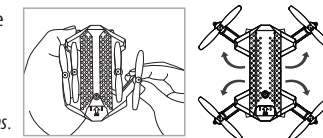

E

ASC-2080 DIAGRAM

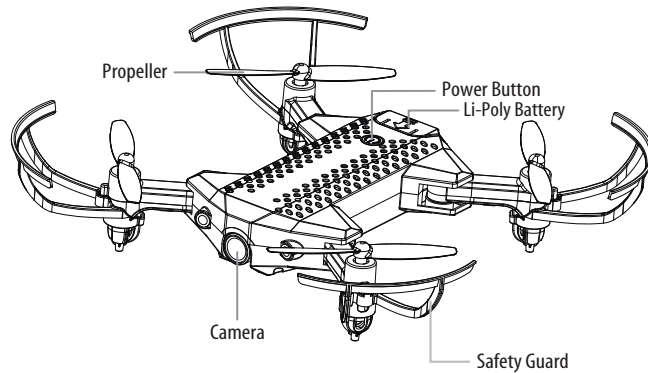

CONTROLLER DIAGRAM

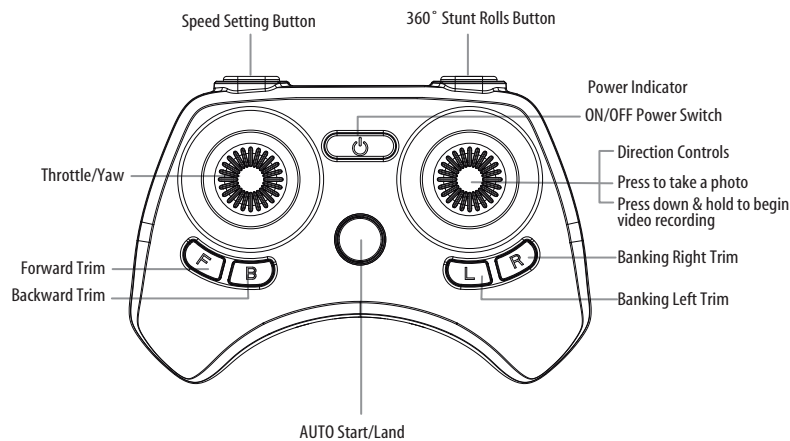

WARNING

DO NOT FLY YOUR ASC-2080 IN FOUL WEATHER!



FLIGHT PREPARATION

- Verify that there are 3 "AAA" batteries inside the remote control unit and the ASC-2080 battery has been fully charged.
- Make sure to be in a large open space preferably a field or a park with an open radius of at least 200 feet.
- Make sure to start your drone on a clean flat level surface before take-off.
- **IMPORTANT! Until you have experience in flying your ASC-2080, it is not advised to use in any rate of wind. Pick a day with zero wind or extremely light wind condition when learning how to fly.**

SYNCING YOUR ASC-2080

Important! When syncing your ASC-2080 with the controller always make sure that the drone is on a flat level surface and that your digital trim settings are in the center position.

1. Before starting, make sure that the power on your controller is off and the battery is removed from the ASC-2080.
2. Insert the battery into the ASC-2080 and set it down on a flat level surface. Press down the power button and hold for a few seconds (see diagram F). The LED lights on the drone should begin to flash.
3. Quickly turn ON the remote and you will notice that the top red LED light on the face of the controller.
4. Push the throttle stick all the way up until it stops and then pull it back all the way down to the bottom (see diagram below). When pushing the stick up or pulling the stick down you should hear a high-pitched beep both ways. If the indicator lights on the drone and controller stop flashing and stay solid on. You have successfully synced your ASC-2080 and are ready to fly. If this doesn't happen, repeat steps 1-4 again.

- **TIP 1: Try not to leave too much time between turning your drone on and turning on the controller, or your syncing window will time-out.**
- **TIP 2: Syncing your drone indoors or in the shade will make it easier to see the LED light indicators on both the controller and the drone.**

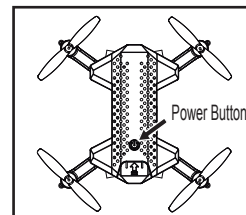

F

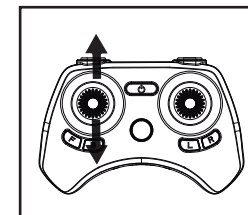

Move the control stick all the way up and all the way down, you should hear two beeps.

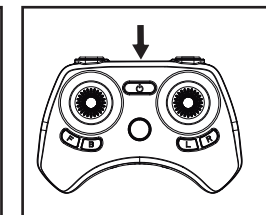

The flashing red LED light will become solid when you are synced.

NOW YOU ARE READY TO FLY!

If you have successfully synced your ASC-2080 to your controller as explained on page 4 you are now ready to fly. Before beginning to fly your drone you should familiarize yourself with how to start and stop the rotors, how to use your auto land feature and how the controls work so please carefully read and familiarize yourself with the various control features explained in the next. Once again as a beginner pilot you should learn how to control your drone in a large open field or park on a day with zero or very light wind. Do not try to fly your ASC-2080 too high until you become a more experience pilot.

RECOGNIZING THE FRONT & REAR OF THE ASC-2080

Even though the ASC-2080 has four rotors there is still a front or "forward" facing direction and "rear" or backwards facing direction. The front and forward facing direction of the ASC-2080 is the side with a camera. The rear and backward facing direction of the drone is the side with a red light (see diagram G).

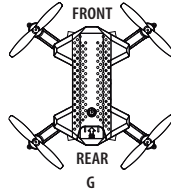

AUTOMATICALLY TAKE OFF / LAND

Make sure you have properly synced The ASC-2080.

- simply press the Auto Start/Land button, your ASC-2080 will automatically take off.
- To stop or land the ASC-2080 just Press the Auto Start/Land button again and the ASC-2080 will descend and land automatically (see diagram H1).

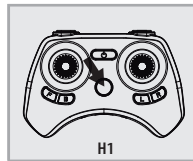

Tips: You also can move the two control sticks simultaneously down inside or outside corners, hold them till the blades start spinning. Release the control sticks and push the throttle stick slowly to take off manually (see diagram H2).



SPEED SELECT BUTTON

The ASC-2080 has 4 speed settings; T(Training), 1 (SLOW), 2 (MEDIUM) and 3 (HIGH). The Default setting when you first turn on your ASC-2080 is the 1 (SLOW) speed mode. To increase the speed simply trigger the speed setting button (see remote diagram on pg 3) you will hear beeping sounds of the controller will show you what speed setting you are on. Speed settings can be set before flight or during the flight.

T (Training)MODE & OBSTACLE AVOIDANCE TRAINING FEATURE

Simply press and hold the Speed Button for 2 seconds, you will hear a long beep indicating you are in T Mode. T mode allows you to learn how to operate your ASC-2080 at a very slow speed. Also there are maximum and minim height limits set to avoid crashing into the ceiling or floor. New obstacle avoidance training feature will cause the drone to automatically circumvent walls and other obstructions so new pilots can get the hang of flying. Set the ASC-2080 speed in the T(Training) speed mode and the obstacle avoidance feature will start working.

Note: the obstacle avoidance feature only works for T(Training) mode.

FLIGHT CONTROL

Below is a list of basic flight functions for your long-range remote to control the ASC-2080. While learning to fly your ASC-2080 it is best to start in a large space with the drone facing away from you until you get used to the basic controls. As you master flying your ASC-2080 you can move to more advanced maneuvering techniques. Practice makes perfect!

Move the left Throttle stick up to increase the propeller speed and the ASC-2080 will ascend.
Move the left Throttle stick down to decrease the propeller speed and the ASC-2080 will descend (see diagram I).

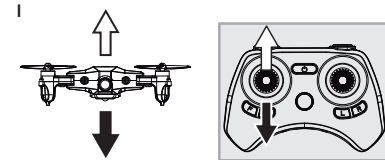

While in the air, move the left throttle stick directly left and the ASC-2080 will rotate horizontally left (counter clockwise)
Move the left throttle stick directly right and the ASC-2080 will rotate horizontally right (see diagram J).

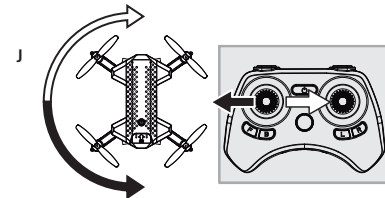

While in the air, move the right direction control stick forward and the ASC-2080 will move forward.

Move the right direction control stick backwards and the ASC-2080 will move backward (see diagram K).

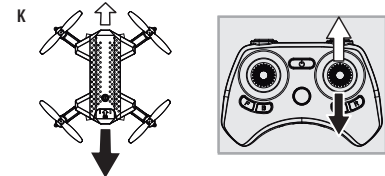

While in the air, move the right direction control stick to the left and the ASC-2080 will bank/sweep to the left.

Move the right direction control stick to the right and the ASC-2080 will bank/sweep to the right (see diagram L).

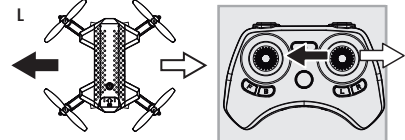

FLIGHT PRACTICE

To master flying your ASC-2080 drone try practicing the exercises shown below, start with simple vertical takeoffs, landings, and left/right turning and rotating. Once those are mastered move on to square and cross maneuvers. Good luck and have fun!

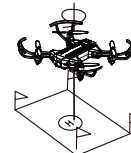

Fixed-Point Landing

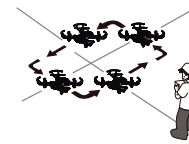

Square Pattern Maneuver



Cross Pattern Maneuver

ADJUSTING THE TRIM

NOTE: The ASC-2080 is already properly trimmed and calibrated right out of the box and should not require any trim adjustments before flying. Some more experienced pilots may want to adjust trim settings for their style of flying. After several crashes you may need to adjust trim settings for the ASC-2080 to be more balanced.

Forward/Backward Trim

• If your ASC-2080 drifts forwards or backwards while in the air, counter the movement by using your forward /backward trim buttons (see diagram M).

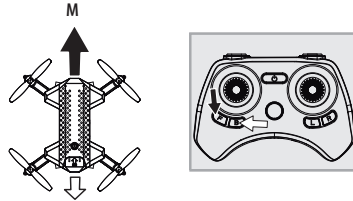

Banking Left/Right Trim

• If your ASC-2080 drifts to the left or right while in the air, counter the movement by using your left / right trim buttons (see diagram N).

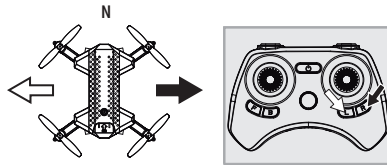

NOTE: The use of the Trim buttons utilizes sounds. A single long Beep indicates the product is center trimmed. When there's no sound when press the trim means the product is trimmed to the maximum on a particular side.

CALIBRATING THE ASC-2080

NOTE: Your ASC-2080 comes pre-calibrated out of the box so you are ready to fly.

After several crashes and shocks to your gyro sensors, you may notice that your drone is drifting and cannot hold its center position while hovering as well as it used to.

This most likely means that you need to recalibrate your ASC-2080. Please follow the simple instructions below.

1. Place the ASC-2080 on a flat level surface
2. Make sure the ASC-2080 is on and that the controller is synced (refer to syncing pg 4). Do not start the blades. Instead move both the throttles and control stick down and to the right corner (see diagram R). You will see the lights on the drone rapidly flash and stop. Once the lights stop flashing you have completed your calibration and are ready to fly!

TROUBLE SHOOTING: If you do not see the lights flash, remove the battery from the drone then turn off your controller and start over. Always make sure to put your battery in before turning on your controller. Push the left throttle stick all the way up and then down touching the top and bottom of the controller. When you hear the beep the ASC-2080 is re-synced to the controller and you are ready to calibrate.

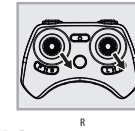

ABOUT 360° STUNT FLIPS

Once you have the confidence in controlling your drone you may begin to execute 360 degree stunts. Your ASC-2080 is tuned to execute flips without the weight of the blade guards. Remove your blade guards for the best performance and remember to operate your ASC-2080 in a large open field or other large open area. Note when doing 360 degree stunts you will be using bursts of energy that may affect the overall flight time of your drone. The more you flip the shorter your overall flight time. When the battery gets low, red and white lights will flash on the body and the flip mode will be automatically disabled to conserve energy for normal flight.

STEPS TO EXECUTING A STUNT FLIP

Performing 360° stunt flips with the ASC-2080 is as easy as 1-2-3:

1. Hover the ASC-2080 in still position making sure that you have at least 5 feet of clearance above and below the quadcopter. Set the speed settings to mode 2 or 3, (the ASC-2080 can not do the stunt in T(Training) mode and speed 1 SLOW).
2. First press the 360 stunt button on the right top side of the controller and you will enter the "stunt roll mode" which is indicated by a rapid beeping sound(see diagram S).
3. Next, using the right control stick, push directly to the right for a "right side roll" or directly to the left for a "left side roll" (see diagram T). Remember to always use caution when performing stunts.

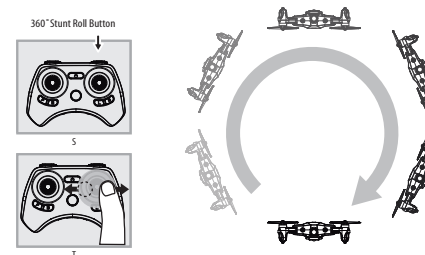

NOTE: To exit the stunt roll mode without flipping simply press the stunt button again and the beeping sound will stop indicating you have exited "stunt mode"

RECORDING VIDEOS AND TAKING PHOTOS WITH YOUR ASC-2080 DRONE

Your ASC-2080 comes equipped with an onboard HD digital camera that takes both video and still photographs. Your ASC-2080 has the ability to record Video and Photos in two places simultaneously! When using the ASC-2080 App you will be able to Stream and Record both Videos and Still Photos directly to your mobile device while at the same time recording Videos and Still Photos in **even greater definition** directly to a Micro-SD card installed on the drone. *Note the Micro SD card is not included and will need to be purchased separately.*

WHAT YOU WILL NEED TO RECORD ON A microSD CARD (this is the highest definition)

1. One microSD card reader (included).
2. One microSD card (not included).
3. A Computer with a USB port and Windows Media Player or other Media player that can play mp4 files.

FORMATTING YOUR microSD CARD

Before you can begin to take videos or digital photographs you must first format your microSD card. To format your microSD card simply place the microSD card into the included USB SD card reader and plug it into your computers USB port (see diagram U1 and U2 below). After a few moments an icon will appear on your Desktop. Right click on the Icon and follow instructions to format your microSD card.

INSTALLING THE microSD CARD IN YOUR ASC-2080 DRONE

- Place the formatted microSD card into the ASC-2080 SD card port (see diagram U3 below). Push gently until you hear and feel the microSD card “click” into the SD card slot.
- Turn the ASC-2080 on and make sure that it is both fully charged and properly synced to the controller (See “HOW TO SYNC YOUR ASC-2080” on page 4).

TAKING DIGITAL PHOTOS

To take photographs short press the CAMERA button of the controller (refer to CONTROLLER DIAGRAM on pg. 3), when you push the button you will hear a “beep” and the red and white led lights on the drone will **flash one time** indicating that a picture has been. taken.

RECORDING VIDEOS

To begin recording a video, **long press** the CAMERA button for 2-3 seconds. You will hear 2 “beeps” and the red and white LED lights on the body will begin to rapidly flash. The flashing LEDs indicate that you have begun recording video. To stop recording and Exit Video mode, simply depress the Camera Button once again. You will hear 2 beeps and the LED lights on the body should stop flashing and become solid.

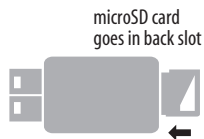

Diagram U1

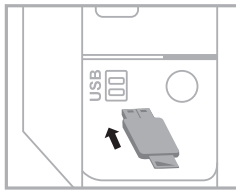

Diagram U2

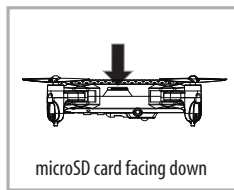

Diagram U3

IMPORTANT NOTICE: It's recommend to test your camera functions before flying.

REMOVING YOUR microSD CARD

To remove your microSD Card push in gently on the back of the SD card with your thumb or forefinger until you hear and feel a “clicking sound”. The microSD card will “pop-out” slightly and is ready for removal. Simply grab and pull gently away from the ASC-2080's camera port to remove the card. Always store your microSD card in a clean, safe and cool environment.

DOWNLOADING AND CLEARING SPACE ON YOUR microSD CARD

Plug your microSD card into the microSD card reader and connect to your computer. It is best to always download all your videos and pictures on to your computer and not store this data on your microSD card. After downloading your photos and videos , follow your computers instructions to “delete” files on your microSD card.

INSTALLING YOUR PHONE HOLDER

Installing your phone holder is required to use your ASC-2080 drone's camera. To install your phone holder, turn your controller around to the back side with the battery compartment facing you and start by clicking in the top “two teeth” into the two holes on the top of the controller and then proceed to click in the bottom (see diagram U4).

To remove, pull from the bottom first.

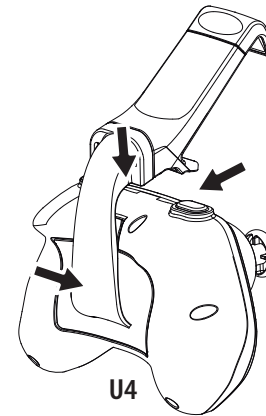

U4

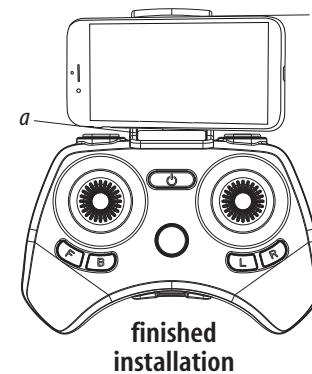

finished installation

CAMERA VIDEO AND PHOTO STREAMING SETUP

Your ASC-2080 comes equipped with an on-board digital camera that takes both video and still photographs and streams them to your mobile device.

WHAT YOU WILL NEED TO GET STARTED USING YOUR CAMERA

1. One Apple or Android Smart phone* (Phone not included).
2. The ASC-2080 App successfully downloaded and installed on your mobile device.

Note instructions on using the App are in the application tutorial

3. To Download the ASC-2080 App, scan the appropriate QR code below which will link to the App on either the Android Play Store or Apple Store. If you are not able to scan the QR code, manually enter the web address located under the appropriate QR code for your phone.
4. After the ASC-2080 App is installed, it should create an icon on your screen (see icon below). Click the icon to run the App and make sure that it has installed correctly on your device. If not, please delete and repeat the process again.
5. Follow the "TUTORIAL" for instructions on connecting/pairing your ASC-2080 drone to the App and using the App for recording film and still photos.

ICON



VA-1000



Apple® iOS
<http://qr03.cn/Bn4HaO>



Android OS
<http://qr03.cn/FqBpEP>

* Apple® devices require the use of iOS 10.0 or higher.
ANDROID™ devices require the use of OS 4.2.2 or higher.

If you're still encountering difficulties downloading the ASC-2080 App, please contact our customer service department at www.amaxbrands.com

TROUBLESHOOTING YOUR ASC-2080

PROBLEM	POSSIBLE CAUSE	POSSIBLE SOLUTION
No Power	1. Power switched off 2. Polarity is reversed 3. Batteries may be low or in need of charging	1. ASC-2080 the ON/OFF switch to ON 2. Make sure all batteries are installed correctly (see diagram A) 3. Replace batteries
Drone Not Responding	1. Remote is switched off 2. Battery power in remote is too weak 3. The remote is not properly synced 4. Out of control range	1. ASC-2080 the ON/OFF switch to ON 2. Replace remote batteries 3. Re-sync the remote 4. Do not fly beyond 200 feet
Drone Won't lift off	1. Rotor speed too slow 2. Drone not fully charged 3. Obstruction of rotors	1. Push throttle lever forward 2. Recharge your ASC-2080 3. Check rotors for hair or other obstructions
Drone Spins, can not be trimmed	Rotor deformation or bad motor	Replace the damaged rotor (You may need to consult with a customer service personnel)
Drone Tilt to one direction	Drone did not calibrate properly	Restart the Drone and controller, properly calibrate it on a flat level surface
Altitude Hold height is not stable, the drone continues to move up and down without locking into position	Drone vibrates too much	Check the propeller deformation

REPLACING THE PROPELLER BLADES

Your ASC-2080's propeller system is a precision instrument that may need repair or replacement from time to time for optimal flight function. Crash landing at high-speed may cause damage to your ASC-2080's propellers.

1. The ASC-2080 has four sets blades, two sets blades with indication number A & B on front, and two sets blades with indication number B & A on the rear (see the diagram V).
2. When replacing the propeller blades, make sure to match the indication markings on the blades.
3. Unscrew and take off the damaged blade.
4. Replace with new correct blade.

Blade Front Left = A
Blade Front Right = B

Blade Back Left = B
Blade Back Right = A

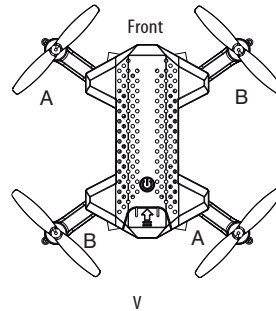

BLADES GUARD INSTALLATION

Your ASC-2080 come with the blade guard for safety flight, it is recommended for beginners.

Simply attached the 4 blade guards to each of landing gear (see the diagram W).

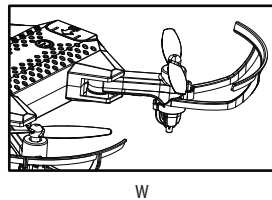
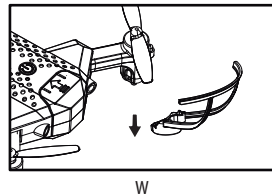

ASC-2080 WARNING:

The ASC-2080 is designed for INDOOR & OUTDOOR use. The ASC-2080's blades revolve at high speeds and can cause damage to the user, spectators and animals. Stand away from the ASC-2080 to reduce the risk of getting into the flight path. Warn spectators that you will be flying your ASC-2080 so that they are aware of its position. Before flight, inspect the rotor blades to make certain that the blades are securely fastened to the ASC-2080.

WARNING!

- Choking/Cutting Hazard. Small Parts/Sharp Rotor Blades.
- Keep hands, hair and loose clothing away from the propeller when the power ASC-2080 is turned to the ON position.
- Turn off the transmitter and ASC-2080 when not in use.
- The included charger is built specifically for the ASC-2080 Li-Poly battery. Do not use it to charge any other battery.
- New alkaline batteries are recommended for maximum performance.
- Parental supervision recommended when flying ASC-2080.

BATTERY WARNINGS

RECHARGEABLE BATTERY:

This ASC-2080 uses a Li-Poly rechargeable battery. If battery no longer stays charged, dispose of battery properly according to local disposal requirements.

CONTROLLER BATTERIES:

Remote control requires 3 "AAA" batteries (not included).

Please read the important battery safety warning below.

- Do not mix alkaline, standard (carbon-zinc) and rechargeable batteries (Nickel Metal Hydride).
- Do not mix old and new batteries.
- Non-rechargeable batteries are not to be recharged.
- Rechargeable batteries are to be removed from the item before being charged (if removable).
- Rechargeable batteries are only to be charged under adult supervision.
- Exhausted batteries should be removed immediately and must be recycled or disposed of properly according to state or local government ordinances and regulations.
- The supply terminals are not to be short-circuited.
- Only batteries of the same or equivalent type as recommended are to be used.
- Batteries are to be inserted with the correct polarity (see inside booklet for diagram).
- Do not dispose batteries in a fire - batteries may leak or explode.

CARE AND MAINTENANCE

- Always remove the batteries from the wireless remote control when it is not being used for an extended period of time.
- To clean, gently wipe the remote control and ASC-2080 with a clean damp cloth.
- Keep the toy away from direct heat or sunlight.
- Do not submerge the toy into water. This can damage the unit beyond repair.
- Parental guidance recommended when installing or replacing the batteries.

- Always avoid manned aircraft.
- Never operate in a careless or reckless manner.
- Keep your drone within sight. If you use First Person View or similar technology, you must have a visual observer always keep your drone within unaided sight (for example, no binoculars).
- You cannot be a pilot or visual observer for more than one drone operation at a time.
- Do not fly a drone over people unless they are directly participating in the operation.
- Do not operate your drone from a moving vehicle or aircraft unless you are flying your drone over a sparsely populated area and it does not involve the transportation of property for compensation or hire.

Limited 90-Day Warranty

NORTH AMERICA

AMAX Group USA warrants to the original consumer that this product is free from any electrical or mechanical defects for a period of 90 DAYS from the date of purchase. If any such defect is discovered within the warranty period, AMAX Group USA will repair or replace the unit free of charge upon receipt of the unit, shipped postage prepaid and insured to our warranty center ALONG WITH THE ORIGINAL RECEIPT evidencing that the product was purchased from an approved AMAX retail partner and that the product is still within the 90 day warranty period. The warranty covers normal consumer use and does not cover damage that occurs in shipment or failure that results from alterations, accident, misuse, abuse, neglect, wear and tear, inadequate maintenance, commercial use or unreasonable use of the unit. Removal of any parts/components voids all warranties. This warranty does not cover cost of repairs made or attempted outside by third-party individuals or companies. Any applicable implied warranties, including warranties of merchantability and fitness, are hereby limited to 90 DAYS from the date of purchase. Consequential or incidental damages resulting from a breach of any applicable express or implied warranties are hereby excluded. Some states do not allow limitations on the duration of implied warranties and do not allow exclusion of incidental or consequential damages, so the above limitations and exclusions in these instances may not apply.

REPAIR/REPLACE PRODUCT

If your product begins to malfunction or stop working, immediately contact our warranty center (contact details listed below). If it is determined that a return is necessary, our warranty department will issue you an RMA number/form and an address to the nearest return center for shipping the product to us. When honoring the warranty, AMAX reserves the right to either repair, replace or refund the product.

IMPORTANT NOTICE:

We will reject and return to sender returns that are not accompanied by an AMAX issued RMA form and RMA number so make sure to contact our warranty center before attempting to return your product!

PREPARATION FOR SHIPPING YOUR PRODUCT:

Please repack your product in a durable box, preferably in the original carton, and send it prepaid, and adequately insured. Include the RMA form that was issued by our warranty department along with your daytime telephone number and email address inside the shipping carton. If your warranty has expired and you still require service please contact our customer care team For further information please send all inquiries to: customercare@amaxbrands.com

IMPORTANT NOTICE!
DO NOT ATTEMPT TO SHIP YOUR PRODUCT BACK
WITHOUT FIRST CONTACTING OUR WARRANTY
DEPARTMENT AT:

www.amaxbrands.com

Email: customercare@amaxbrands.com