

the power knob. When hunting, it is generally best to use the lowest magnification setting for the widest field of view and brightest image and save high magnification for stationary game at long range.

ADJUSTABLE OBJECTIVE

Osprey hunting models have their objectives factory set for a distance of 100 yards. Osprey Tactical/Target models are equipped with an adjustable objective. This feature allows you to focus for the distance you are shooting. This not only provides the sharpest possible image, it also eliminates parallax. Parallax is an optical phenomenon where the image of the reticle (or crosshair) and the target are in two different image planes (locations). This phenomenon presents itself as an apparent change in the reticle's position against the target when the shooter's eye is moved off axis. It is most apparent at higher magnifications and may lead to a point of impact shift.

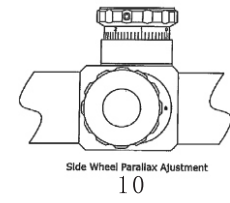

15

Lenses
Should the lenses become dirty, blow loose materials off the lenses before cleaning. Use lens cleaning fluid and a soft cloth to dab at the surface and remove any abrasive bits of dust and dirt before applying more pressure. Be patient and clean in steps so as to not grind abrasive dust and dirt into the lens. The optical coatings are hard and will last indefinitely with proper care.

Exterior
The body of the scope should be wiped down occasionally to remove fingerprints or dust. Do not use oil or solvent as these may be harmful if inadvertently rubbed onto the optical coatings.

Mechanical & Storage
Mechanical parts have been lubricated at the factory with special hermetic grease and need no further attention. This grease is temperature-stable from -50 to +175 degrees Fahrenheit. Do not store at temperatures outside this range (for example a car trunk on a very hot day).

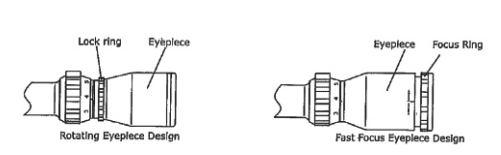

Rotating Eyepiece Design
1. Hold the eyepiece in one hand and loosen the lock ring by rotating it counterclockwise away from the eyepiece.

2. Point the scope at a bright, featureless surface any distance away (blank wall, sky, a sheet of white paper) and with your eye about three inches from the eyepiece, rotate the eyepiece clockwise or counterclockwise until the reticle becomes clear and sharp. It may help to look away and then back through the eyepiece to confirm the correct setting.
3. When confirmed, retighten the eyepiece lock ring.

Fast Focus Eyepiece Design
If your model is equipped with a fast focus eyepiece, there is no lock ring. As above, view a well-lit featureless surface. Then, you simply rotate the fast

4

RANGEFINDING OVERVIEW

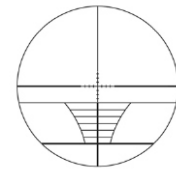

The Range Finder Reticle is designed to enhance the long range accuracy and ranging capabilities of the average shooter. The range finder reticle has two separate parts; the first part is the aiming reticle, while the second half is a "choke style" range estimator. The hash marks in the center part of the reticle are spaced in 5 MOA increments from one another. This is used to quickly determine the size of larger objects, as well as be used for bullet drop compensation for long range targets. (1 MOA is equal to 1 inch at 100 yards, thus 5 MOA is equal to 5 inches at 100 yards.)

21

The range-finding "choke" in the lower portion of the reticle is a pair of curved lines that taper down. The "choke" has a series of horizontal lines that correspond to a specific range in yards. This "choke" is calibrated for the average sized human shoulder width of 18 inches. You will be able to estimate the distance of a human silhouette or any other 18 inch wide target.
To utilize the "choke" reticle, you will need to bracket the edges of the target between the tapering choke lines. (LL. 1)

ILL. 1

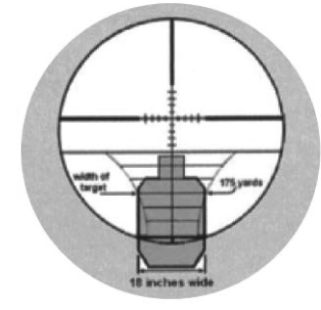

22

TELESCOPIC SIGHT INSTRUCTION MANUAL

Congratulations on your selection of an Osprey scope. This scope has been carefully crafted and quality assured to provide years of trouble-free service on all firearms.

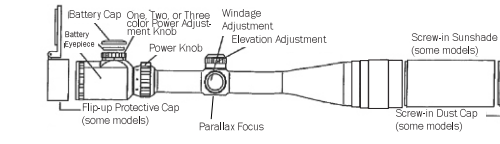

CAUTION: BE SURE THAT THE FIREARM IS NOT LOADED. PRACTICE SAFE FIREARM HANDLING AT ALL TIMES.

EYEPiece FOCUSING

The purpose of eyepiece focusing is to adjust the scope so that the reticle (crosshairs) appears clear and sharp. All Osprey riflescopes are factory set for 20/20, or corrected to 20/20 vision. If the reticle does not appear sharp, you can adjust it as follows.

3

SPECIFICATIONS FOR OSPREY RIFLE SCOPE

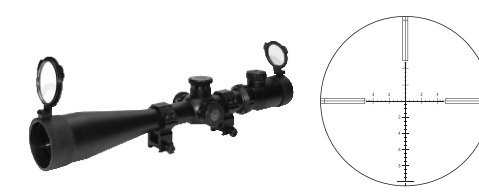

Specification	ES4-16x56MOG	ES8-32x56MOG
Magnification	4-16	8-32
Objective(mm)	56mm	56mm
Tube Diameter(mm)	30mm	30mm
Field of View(feet at 100yds)	26.3x6.6	12.1x3.1
Parallax(yards)	100yds	100yds
Reticle Image Plane(Magnifying)	M1 line	M1 line
Exit Pupil(mm)	13.3mm-4.4mm	7mm-1.75mm
Eye Relief(inches)	3.66"-3.35"	4.2"-3.46"
Length(inches)	12.2"	14.3"
Weight(ounces)	27.2	26.8
Finish	Black Matte	Black Matte
MOA	1/4"	1/8"
Elevation/Windage Adjustment	25'	25'
Dropper Adj	25'	25'

16

All Osprey Tactical/Target models and several hunting models have reset windage and elevation knobs. After zeroing, they enable you to reset the zero mark on the windage or elevation to the index mark on the scope. If you wish to do this, it can be done as follows:

After zeroing at the desired sight-in distance (see zeroing below) use the included hex wrench to loosen the three small setscrews that secure the marked drum to the windage/elevation knob. When loose, rotate the drum (only the drum, not the knob) until the zero mark corresponds to the index mark on the body tube or turret. Take care to not rotate the knob (making clicks) when rotating the drum or your zero setting will be changed. When the drum has been tightened, it is possible to make adjustments in the field and easily return to your "zero" setting.

ZOOM MODELS

Many Osprey scope models have variable magnification or "zoom" capabilities. This enables the shooter to accommodate a wide variety of shooting situations. To change magnification, simply rotate

9

Value of 1/8 MOA in inches:
25 yards one click equals 0.03 inch.
50 yards one click equals 0.06 inch.
75 yards one click equals 0.10 inch.
100 yards one click equals 0.13 inch.
150 yards one click equals 0.20 inch.
200 yards one click equals 0.26 inch.
500 yards one click equals 0.66 inch.
1000 yards one click equals 1.31 inches.

Value of 1/4 MOA in inches:
25 yards one click equals 0.06 inch.
50 yards one click equals 0.12 inch.
75 yards one click equals 0.20 inch.
100 yards one click equals 0.26 inch.
150 yards one click equals 0.40 inch.
200 yards one click equals 0.52 inch.

Value of 1/2 MOA in inches:
25 yards one click equals 0.12 inch.
50 yards one click equals 0.24 inch.
75 yards one click equals 0.40 inch.
100 yards one click equals 0.52 inch.
150 yards one click equals 0.8 inch.
200 yards one click equals 1.04 inch.

Your Windage and Elevation are pre-centered at the factory to provide a maximum range of adjustment in all directions from center. The knobs are marked "up" or "R" and have an arrow indicating the direction of rotation necessary to move the point of impact.

8

Features of Osprey Signature TA 10-40x50 MOG Riflescope Matte Black

- The Osprey scope model is entirely unique and custom made to Osprey
- Chinese labor is utilized, but no major Chinese components
- U.S. made 3m or loc-tite epoxy used in all bonding applications
- Imported hermetic grease is used for superior waterproof and fog-proof performance
- Recall tested at 50 BMG parameters(1000g/0.4-0.8ms)
- Waterproof tested at 25 cm/40 degree C for three minutes
- Fog-proof tested at 20 degrees C for thirty minutes and removed to ambient (each scope must completely clear in 2 minutes)
- Each scope is spin-centered for balance before leaving the factory
- No-nonsense lifetime warranty/three day repair or replacement
- Optical lenses from Hoya of Japan
- 100% of all units are inspected to ensure quality
- Each scope is all glass, with all air-to-glass surfaces

17

and water-proofing, and every scope is tested and warranted for shock to 50 BMG parameters (1000g/0.4-0.8ms). Each scope is also spin-centered for balance and possesses fully, multi-coated glass lenses throughout with glass-etched reticles. Our scopes have now reached sales of over 100,000 plus units and devoid of being bias, we feel it is the best scope dollar-for-dollar ever available. Albeit we may seem to be making some bold and pretentious statements, we feel anyone who purchases our scopes will agree. We will also work to continue improving and reducing costs on our many other key products, including but not limited to green lasers, tactical lights, red lasers, and the many other items we have provided in years past. In closing, we would like to thank all of our past and future customers, and look forward to many years of providing you with quality products, affordable prices, and the best customer service and warranty in the business.

Keith Oliver • CEO
Randy Burke • President

2

After bracketing the target in the choke, count the number of lines down the choke to determine the target distance. The top line is equal to 100 yards with each line below being further in 25 yard increments. (LL. 2)

ILL. 2



The "choke" lines are not intended to be used as a ballistic reticle. This portion of the reticle is only intended for the range estimation of an 18 inch target. After "ranging" you target, make the appropriate adjustments to the Bullet Drop Compensator (BDC) if equipped on your scope, or adjust your scope's elevation to compensate for the bullet drop at the determined range.

23



Osprey, a leader in the weapon accessory industry for over 15 years, concentrates on cutting-edge, niche products that are innovative in design and performance for our discerning customer base. Our entire product line also carries a full, no-nonsense, lifetime warranty. Our chamberable bore sight system has been tested in Iraq and Afghanistan and approved for use by the U.S. Military for the sniper accessory kits. It is simply the best bore sight system in the world. We also allow for a variety of arbors that work in conjunction with the .223 and 30 Carbine Bore sights, which we painstakingly developed over many years. Below are some of the points which separate Osprey from all the others. Our rifle scope line is assembled in China, where we utilize Chinese labor but not Chinese components. For example, the lenses used in our tactical scope family are from Hoya of Japan, and we import 3M and Lo-tite two-part epoxies and hermetic grease from the United States for all bonding applications. 100% of the units are inspected for fog-proofing

1

faces fully multi-coated
• Inside of each body tube is specially treated with anti-reflective paint and light stops to reduce internal reflections

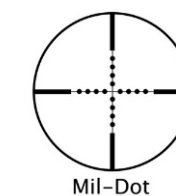

MIL-DOT OVERVIEW

A Mil-Dot reticle is named for the dots and spaces it is composed of. The space between the dots is one milliradian, or "mil" for short. A mil is a unit of angular measurement, like degrees or minutes of angle. It represents one unit of angular width for every 1,000 units of distance. This arrangement is very useful for determining the distance of objects of a known size.

18

WINDAGE AND ELEVATION

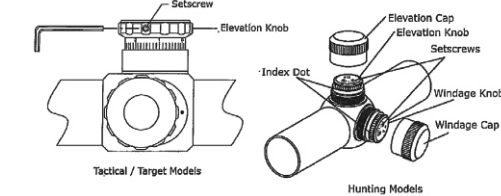

Your Osprey scope has precise windage (left and right), elevation (up and down), and adjustments, with audible and tactical clicks. The click value is 1/4 MOA for hunting models and 1/8 MOA for tactical/varmint models. You can find click value for your scope marked on the windage/elevation knob. The following table will be useful when zeroing (described later in the manual) or making adjustments in the field.

7

cross bolt fits into the grooves provided. Tighten loose enough so that the scope can be slid forward and backward and rotated.
2. With the firearm held in a comfortable shooting position, slide the scope forward and backward until a full field of view is achieved.

CAUTION: BE SURE THAT THE SCOPE IS MOUNTED A SUFFICIENT DISTANCE FROM YOUR EYE TO PREVENT CONTACT UNDER RECOIL.

Next, rotate the scope so that the elevation knob is on top, the windage on the right side and the vertical and horizontal portions of the crosshair are aligned with the vertical and horizontal axis of your firearm.

3. Carefully tighten the screws and double-check that you have enough distance between your eye and the scope to avoid contact under recoil, and that the scope's vertical and horizontal is aligned with your firearm. For additional security, a drop of thread-locking fluid can be added to the screws before final tightening.

6

If the size of an object is known, its distance can be calculated as follows. Measure the object with the reticle, counting how many mil sections it covers. Dividing the size of the object by the number of mils and multiplying by 1000 can now calculate the object's distance.

(Object size/quantity of mils) x 1000 = distance

Note that the unit of measurement used for the object size and the calculated distance will be the same. That is, if the object is in yards, the calculated distance will also be in yards; if size is in meters, distance will be in meters.

Example: An object has a height of 2 yards. With the reticle, this object is measured and found that it covers exactly 5 mils.
(2/5) x 1000 = 400 yards

Or if the same object is measured in meters:
(1.83/5) x 1000 = 366 meters

19

No-Nonsense Lifetime Warranty



Osprey Global
20000 Glenhurst Road
Whittier, CA 90608
Sales@osprey.com

Signature Series
MANUAL

TRAJECTORY & DEFLECTION

To accurately engage a target at a distance greater than sight-in, requires that the trajectory of the specific load being used is well understood. This is available from ammunition suppliers, derived from ballistic software, or determined by actual use. In the above example, an object's distance was determined to be 400 yards. If zeroed at 100 yards, a specific load may drop by 25.6 inches at that distance. The value of one mil at 100 yards is slightly greater than 3.6 inches. (This equates to 7.2 inches at 200 yards, 14.4 inches at 400 yards, and so on.) Knowing this, it can be calculated that a little less than 2 mils of up elevation is needed. The reticle can then be used as a "hold over" guide to quickly engage the 400 yard target. If susceptibility to wind drift is known for the load being used, the dots on the horizontal axis can be used in a similar fashion as references to compensate for wind deflection or lead in the case of a moving target. Ideally, adjustments for distance and deflection should be made with the windage and elevation knobs, but the mil-dot reticle is a useful quick-aiming reference.

20

focus element in or out to make the reticle appearance clear and sharp.

CAUTION: BE SURE THAT THE FIREARM IS NOT LOADED. PRACTICE SAFE FIREARM HANDLING AT ALL TIMES.

MOUNTING

To get the best performance from your Osprey scope, it must be mounted properly. If you are not familiar with mounting a rifle scope, it is strongly recommended that you seek the assistance of a qualified gunsmith. If you decide to mount it yourself, proceed as follows:

1. Some Osprey models come equipped with ring-mounts. If yours did, it will have either weaver-style ringmounts (for most high-power applications and some crossbows) or 3/8" ringmounts (for rimfire, air rifle, and some crossbows). Examine your mounting rail or grooved receiver to determine if you have the correct ringmounts. If so, loosen the mount screws and attach the ringmounts to either your weaver-style rail or 3/8" rail. Care should be taken when attaching to a weaver-style, that the ringmount's

5

Final Zeroing (Live Fire)

CAUTION: USE ADEQUATE EYE AND EAR PROTECTION AT ALL TIMES. SHOOT ONLY AT AN APPROVED RANGE OR SUITABLE SAFE AREA.

Position the target no further than 25 yards away to begin the zeroing process. If you have a zoom model, select the highest magnification. If you have a model with an adjustable objective, set it for 25 yards.

CAUTION: IF YOU HAVE USED A BORE SIGHTER, CONFIRM THAT THE BORE SPUD IS NO LONGER IN THE MUZZLE AND THAT THE BORE IS UNOBSTRUCTED.

With the firearm on a steady rest, carefully fire three rounds and note where they strike on the target. Your group should strike the target no greater than 4 inches high, 7 inches low, or 6 inches left or right of your point of aim. (Should this group be further away than this, either the mounts or the mounting process is faulty and must be corrected before proceeding.) Make adjustments to windage and elevation so that your group strikes the target approximately

12

1 inch beneath the point of aim with no windage error (at six o'clock, neither left or right). Fire three more rounds and adjust as necessary. When done, position the target at the desired zero distance. Fire three rounds at this distance and adjust as necessary to hit dead-on. If your scope is equipped with a bullet drop compensating reticle, refer to the special insert included with your manual. When final zeroing is complete, be sure to securely tighten down the protective caps for your windage and elevation.

ILLUMINATED RETICLE

Some models are equipped with single and two-color reticle illumination systems. These models have special glass-etched reticles where only the targeting portion of the reticle is illuminated. Single color systems have 11 rheostat settings that illuminate the reticle in red. Three color models have red, green, and blue illumination available. The green color can be used effectively in brighter ambient light, where red is generally preferred for lower light applications. In very low light conditions, a setting should be selected that is not so bright as to create a "halo" which can obscure the target. As this system will enable you to effectively shoot in very low

13

light, extra care should be taken to properly identify the target with binoculars or spotting scope. Under no condition should you use your rifle scope to "scan" or "spot" game. This may result in you inadvertently pointing your firearm/crossbow at another person.

BATTERY

If your scope has an illuminated reticle, a 3-volt lithium battery is included. This battery can be stored for several years without losing power. However, it is recommended that an extra battery be carried when in the field. This is especially true if the weather is excessively cold, as this will reduce battery life.

Battery type: NEDA #2032
Lithium 3 volts

MAINTENANCE & CLEANING

Your Osprey scope is extremely durable. But it is a precision instrument and should be treated with reasonable care. When not in use, be sure to cover the objective and ocular lenses with the provided lens caps.

14

Finding the best setting for the adjustable objective can be done in one of two ways. You can simply focus until the clearest image is achieved, or use the yardage markings on the objective bell to set for the distance being shot.

ZEROING

Bore Sighting

CAUTION: BE SURE THAT THE FIREARM IS NOT LOADED. PRACTICE SAFE FIREARM HANDLING AT ALL TIMES.

Bore sighting should be done to achieve rough alignment of the scope to the firearm. This is best accomplished through the use of an optical bore sighter. If a bore sighter is not available, place the firearm on a sturdy rest and sight down the bore or along the barrel at a small target about 50 yards away. Unscrew the protective caps from the windage and elevation adjustments and adjust until the crosshair corresponds with the target viewed through the bore or alongside the barrel.

11