



TA750

IONIC AIR PURIFIER
ionicpro
PLATINUM

IONIC AIR PURIFIER
ionic pro[®]
PLATINUM™



TA750

Owner's

Manual

IONIC AIR PURIFIER
ionic pro
PLATINUM

Thank you for purchasing the Ionic Pro® Platinum and congratulations on taking this important step in improving the quality of air in your home, office and other environments. Customer satisfaction is our number one goal. Your Ionic Pro® Platinum is a premium air purifying appliance which comes with a limited one-year warranty.

Enjoy your Ionic Pro® Platinum and visit our website for more exciting quality products and upgrades.

www.envion.com



TABLE OF CONTENTS

SAFETY INSTRUCTIONS	1
PRODUCT BENEFITS	3
MAIN PARTS	4
OPERATING THE IONIC PRO® PLATINUM AIR PURIFIER	5
Getting Ready	5
Controls/Settings	5
OPERATION	6
Selecting a Setting	6
CLEANING & MAINTENANCE	7
Clean Light	7
Preparing to Clean	8
Cleaning the Permanent Ionic Filter	9
Cleaning the Pre-Filter	10
Cleaning External Surfaces	11
TROUBLE-SHOOTING	12
ONE-YEAR LIMITED WARRANTY	13
ARBITRATION AGREEMENT	14

SAFETY INSTRUCTIONS

EXTREMELY IMPORTANT INFORMATION: Safety precautions should always be used when operating this or any electrical appliance. Decrease the risk of electrocution, electric shock, injury or fire by reading and following all the warnings below:

- Use only as described in this Ionic Pro® Platinum Owner's Manual. To reduce the risk of electric shock, do not attempt to service the product in any way other than in the manner described in the "**CLEANING & MAINTENANCE**" section of this manual.
- Do not use the Ionic Pro® Platinum outdoors.
- Do not use the Ionic Pro® Platinum in bathrooms or other humid environments, near fireplaces or in areas where flammable or combustible vapors or products may exist.
- The Ionic Pro® Platinum operates at 120v AC and 60Hz only.
- To reduce the risk of electric shock, this product has a grounding-type plug that has a third grounding pin. This plug will fit only into a grounding-type power outlet. If the plug does not fit into the outlet, contact qualified service personnel to install the proper outlet. Do not alter the plug in any way.
- Always turn off all controls before unplugging the Ionic Pro® Platinum from outlet.
- Always turn off and unplug this product from outlet before removing or inserting the electrostatic filter permanent ionic filter or pre-filter.
- Never touch the electrodes or any other internal part except the filters within the Ionic Pro® Platinum with your hand or with any object. Do not open the outer casing of the Ionic Pro® Platinum. Attempting to open the unit will cause the warranty to be voided and could cause serious personal injury to the user and/or result in considerable damage to the unit.
- Do not place the Ionic Pro® Platinum cord near a heated surface.
- Never operate the Ionic Pro® Platinum if the plug or cord is damaged or appears damaged. Only qualified service personnel should ever replace or attempt to replace a damaged power cord.
- Never use the power cord to pick up, carry, drag, pull, or lift the Ionic Pro® Platinum. Do not pull the cord against or around sharp corners and edges. This could result in injury to the user and damage to the cord.
- Always remove the plug from its power outlet by holding onto the plug itself and pulling gently. Never pull on the cord itself to unplug it from its power outlet.

SAFETY INSTRUCTIONS

- Use care when operating the Ionic Pro® Platinum by keeping all fingers, body parts, hair, loose clothing and jewelry away from openings.
- Never touch the Ionic Pro® Platinum or its plug with wet hands.
- The Ionic Pro® Platinum is an electrical appliance. Ionic Pro® Platinum should be operated by adults only.
- After removing the permanent ionic filter from the unit, immediately discharge residual electricity by touching blades to an electrical ground such as a water pipe or metal faucet.
- The permanent ionic filter should be inspected frequently and cleaned regularly to prevent excessive accumulation that may result in an electrical flashover or risk of fire.
- Always re-insert the permanent ionic filter and pre-filter in a vertical manner.
- This product complies with the maximum allowable concentration of ozone of 0.050 parts per million by volume (ppmv) in a 24-hour period. The Health Canada Guideline 2010 recommends that the maximum exposure limit, based on an averaging time of 8 hours, is 0.020 ppmv or less when tested in a sealed, controlled room approximately 30 m³."

WARNING

Chemical Burn Hazard. Keep batteries away from children.

- This product contains a lithium button/coin cell battery. If a new or used lithium button/coin cell battery is swallowed or enters the body, it can cause severe internal burns and can lead to death in as little as 2 hours. Always completely secure the battery compartment. If the battery compartment does not close securely, stop using the product, remove the batteries, and keep it away from children. If you think batteries might have been swallowed or placed inside any part of the body, seek immediate medical attention.
- The cells shall be disposed of properly, including keeping them away from children.
- Even used cells may cause injury.



PRODUCT BENEFITS

YOUR IONIC PRO® PLATINUM BOASTS:

- Ultra quiet operation.
- ENERGY STAR® certification.
- Compact tower design that sits on a table or floor.
- Permanent ionic filter never needs replacing and is dishwasher safe.
- 24 hour timer



MAIN PARTS

Before using your Ionic Pro® Platinum, please read all the information contained in this manual.

Figure 1

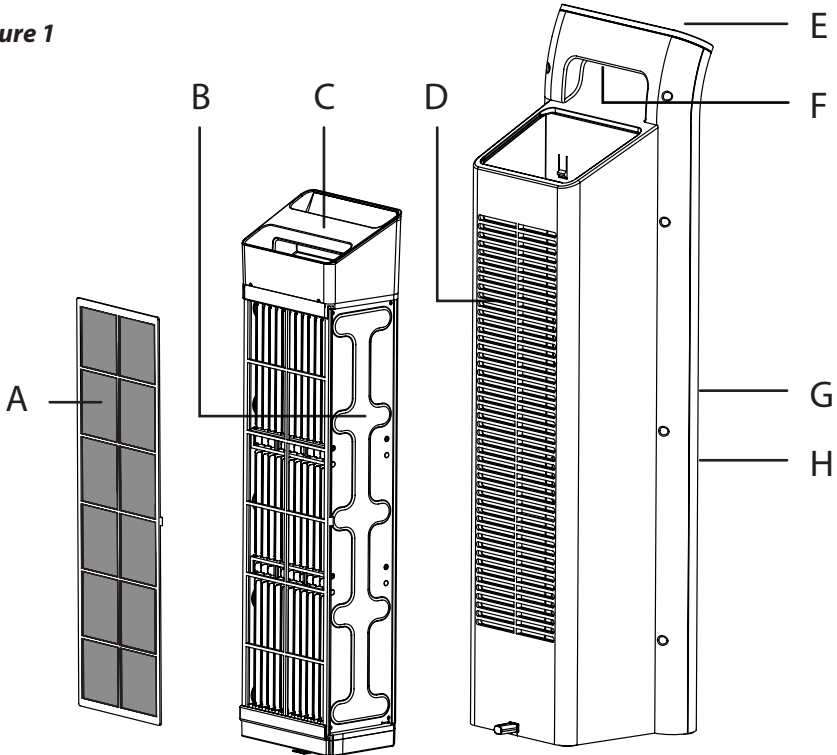

A. PRE-FILTER

This filter traps large particles such as hair and lint.

B. PERMANENT IONIC FILTER

This is the permanent ionic filter. It's a vital part of this amazing air purifying system. This is where smoke, dust, allergens and irritants are trapped when the Ionic Pro® Platinum is in use.

C. PERMANENT IONIC FILTER HANDLE

D. AIR INLET GRILL

E. CONTROL PANEL

F. HANDLE FOR LIFTING / MOVING

G. IONIZING CLEANING SWITCH *See Figure 3.*

H. AIR OUTLET GRILL

OPERATING THE PLATINUM

GETTING READY

Locate a level surface on which to place your Ionic Pro® Platinum near a grounded 120v outlet. Position your Ionic Pro® Platinum at least one foot from the wall. Follow warnings described in the “**SAFETY INSTRUCTIONS**” section of this manual.

Plug in the unit. *You are now ready to turn on your Ionic Pro® Platinum!*

CONTROLS/SETTINGS

Control Panel



Figure 2

TIMER

Timer is programmable up to 24 hours.

MODE BUTTON

SILENT

Lowest speed setting. Silent operation.

GERM

Medium speed. Quiet operation.

ALLERGY

High speed.

MAX

Highest speed.

DIM

Allows you to dim the control panel lights.

CLEAN FILTER

This blue light goes on when the Ionic Pro® Platinum needs to be cleaned, or the unit is experiencing some other problem. See the “**CLEANING & MAINTENANCE**” and the “**TROUBLE-SHOOTING**” sections of this manual for more information.

NOTE: It is recommended to clean the permanent ionic filter every 8 weeks.

ON/OFF BUTTON

Turns the unit on and off and controls the fan speed.

OPERATION

SELECTING A SETTING

Set up the Ionic Pro® Platinum as described in the “**GETTING READY**” section of this manual. Push the **ON/OFF** button to activate the Ionic Pro® Platinum.

Select the desired fan speed by pushing the **MODE** button.

Push the button to cycle through the settings. The **LED** indicators will light up to indicate your current setting.

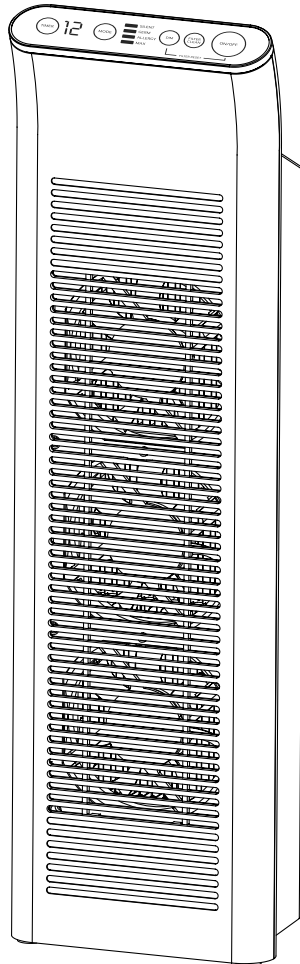

CLEANING AND MAINTENANCE

CLEAN FILTER LIGHT

If the unit has not been regularly cleaned and an excessive amount of dirt has collected on the permanent ionic filter, the unit will shut down and the blue light will turn on. This light will turn on every 8 weeks to remind you to clean the filter. Simply clean the permanent ionic filter by following the “**CLEANING & MAINTENANCE**” section of this manual and when complete, press the **ON/OFF** and **DIM** buttons together to reset.

CLEANING THE IONIZER

For maximum performance we recommend that you clean the ionizer each time you clean the Permanent Ionic Filter. Locate the Ionizing cleaning switch on the front grill of the Ionic Pro® Platinum. See Figure 3.

Push the rod towards the center of the grill. The rod will move about 0.5 inch forward before it will come to a stop. Release the rod. Repeat this 2 to 3 times.

CLEANING & MAINTENANCE

If you hear excessive noise or static coming from your Ionic Pro® Platinum it generally indicates that the product needs to be cleaned. Turn off your Ionic Pro® Platinum, unplug the cord and carefully follow the cleaning instructions in the “**CLEANING & MAINTENANCE**” section of this manual.

Keep the Ionic Pro® Platinum functioning properly by cleaning the permanent ionic filter and pre-filter after every 8 weeks of use as recommended. More frequent cleaning will be necessary if the unit is located in an area with a high level of airborne contaminants (excessive amounts of smoke, pet dander, etc.).

Exposing the Ionic Pro® Platinum to candle, oil lamp, fireplace soot, and smoke is not recommended and will require the collection blade assembly and pre-filter to be cleaned more frequently.

HELPFUL TIP: If your unit doesn't work and the CLEAN FILTER light is on, it's time to clean the filters.

Figure 3

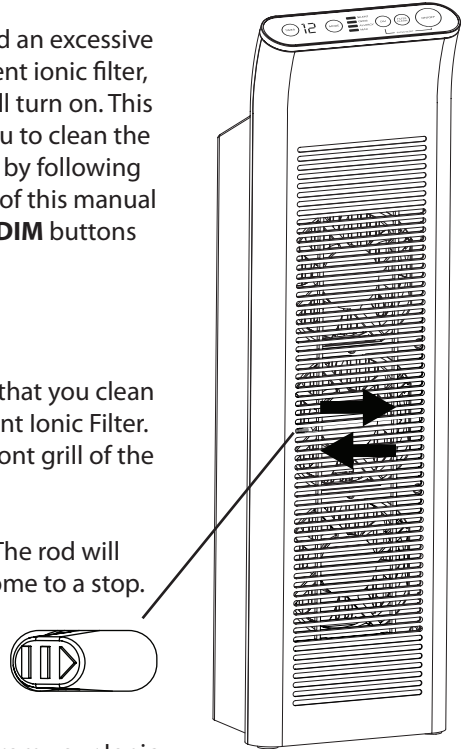

CLEANING AND MAINTENANCE

PREPARING TO CLEAN:

1. Turn off and unplug your Ionic Pro[®] Platinum and let it rest for 60 seconds.
2. Remove the permanent ionic filter by taking hold of the handle and lifting upwards. *See Figure 4.*
3. After removing the permanent ionic filter from the unit, immediately discharge residual electricity by touching blades to an electrical ground such as a water pipe or metal faucet.
4. Remove the pre-filter from the ESP cell. *See Figure 7.*

Figure 4

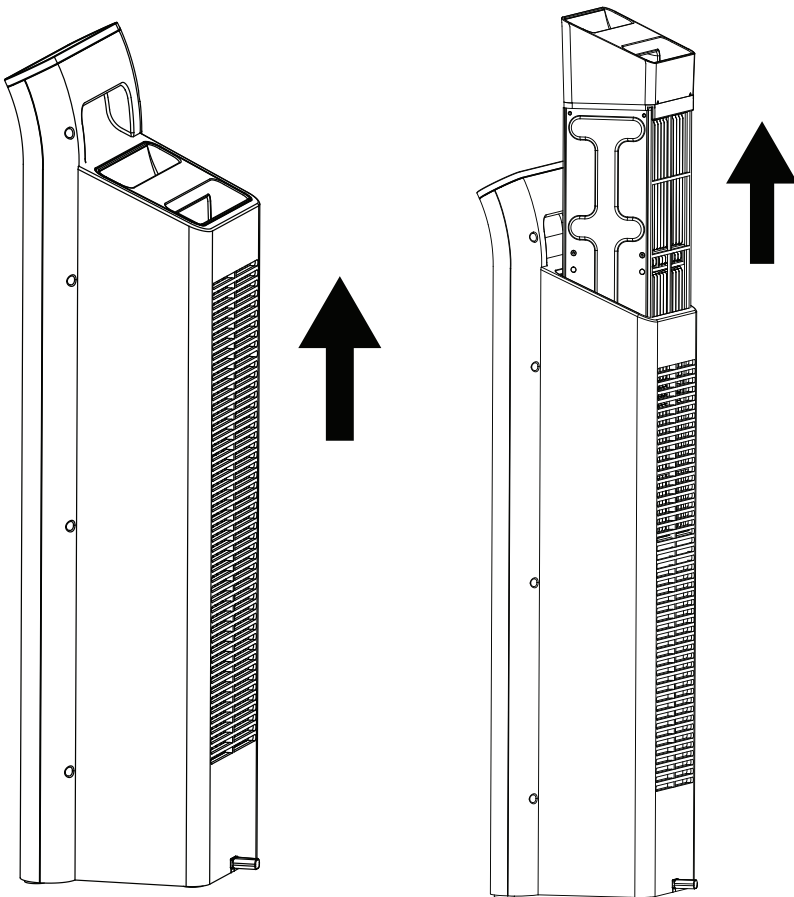

CLEANING AND MAINTENANCE

CLEANING THE PERMANENT IONIC FILTER:

DISHWASHER

1. Put the permanent ionic filter into the dishwasher — making sure not to damage or bend the blades.
2. Remove from dishwasher at the end of the cleaning cycle.
3. **VERY IMPORTANT:** Ensure that the permanent ionic filter is thoroughly dry before installing it into the purifier and resuming use.
4. Always make sure your air purifier is turned off and unplugged before attempting to vertically re-insert the permanent ionic filter.

HANDWASH

1. Place the permanent ionic filter into warm, soapy water and let stand for approximately 10 minutes. *See Figure 5.*
2. Remove from water and rinse with warm water. Repeat as necessary. If your filter is excessively dirty, you can use a soft bristle brush to clean the blades. Make sure not to damage or bend the blades. *See Figure 6.*
3. You may use a household degreaser for severe smoke or grease build up on the permanent ionic filter. Please follow the instructions for the household degreaser.
4. **VERY IMPORTANT:** Wait until the permanent ionic filter is thoroughly dry before re-inserting it into the purifier and resuming use.
5. Always make sure your air purifier is turned off and unplugged before attempting to vertically re-insert the collection blade assembly and pre-filter.

NOTE: *If you insert a wet part, the fan will not turn on and the CLEAN FILTER light will go on. Simply take out the part and let it dry.*

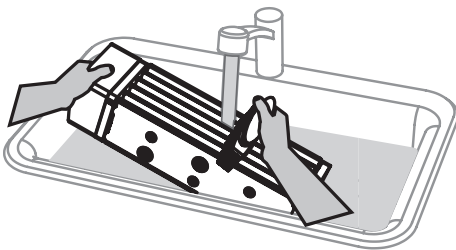

Figure 5

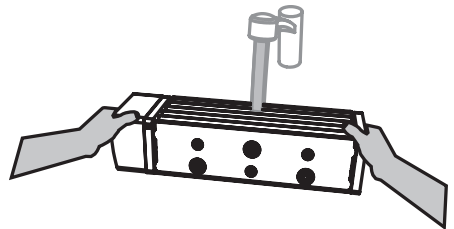

Figure 6

CLEANING AND MAINTENANCE

CLEANING THE PRE-FILTER:

NOTE: The pre-filter is attached to the back side of the permanent ionic filter. See Figure 7.

1. When in use, the pre-filter removes larger particles from the air circulating through your Ionic Pro® Platinum.
2. It can either be hand-washed in cold water or vacuumed.
3. However you clean it, make sure it is absolutely dry before attempting to vertically re-insert it into your air purifier and resuming use.
4. Always make sure your air purifier is turned off and unplugged before attempting to vertically re-insert the permanent ionic filter or pre-filter.

IMPORTANT DRYING WARNING

To avoid damaging your air purifier, make sure the permanent ionic filter and pre-filter are completely dry and free of all moisture before attempting to vertically re-insert them into your air purifier and resuming use.

NOTE: If you insert a wet part, the fan will not turn on and the CLEAN FILTER light will go on. Simply take out the part and let it dry.

Always make sure your air purifier is turned off and unplugged before attempting to vertically re-insert the permanent ionic filter and pre-filter.

Figure 7

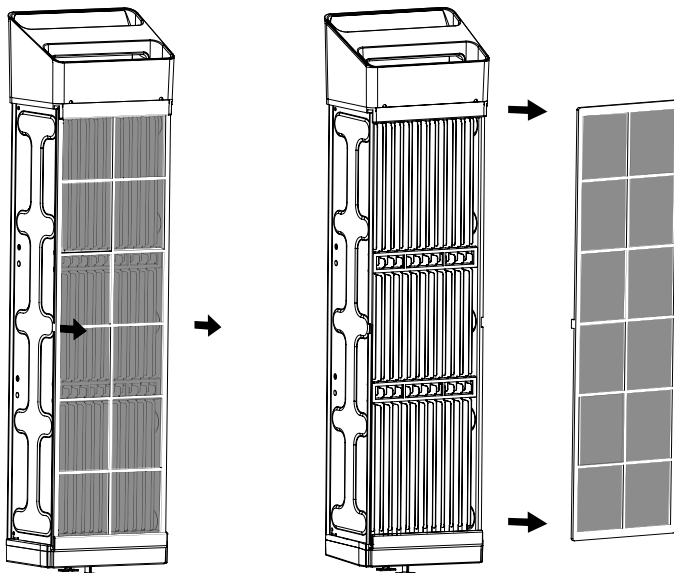

CLEANING AND MAINTENANCE

CLEANING EXTERNAL SURFACES

Over time, some particles and dust may accumulate on the external surfaces of your Ionic Pro® Platinum.

TO CLEAN EXTERNAL SURFACES:

1. Turn off and unplug the unit.
2. Use a moist washcloth with a little dishwashing soap to wipe the outer case surfaces.
3. Do not allow water to slip into the internal parts of the air purifier as this could damage its functioning and may result in injury to you.
4. Allow the unit to dry thoroughly before resuming use.

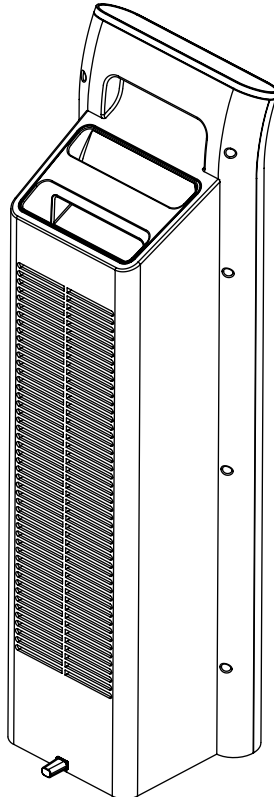

TROUBLESHOOTING

PROBLEM	REASON	SOLUTION
Unit will not turn on.	<p>Unit is unplugged.</p> <p>Unit has not been turned on.</p> <p>Permanent ionic filter and pre-filter are not completely inserted.</p>	<p>Check if plug is loose.</p> <p>Push control button.</p> <p>Check to see that the permanent ionic filter and pre-filter are completely seated in the housing.</p>
<p>Blue CLEAN FILTER light is on.</p> <p>Fan is off.</p>	<p>Too much dust has accumulated.</p> <p>Permanent ionic filter is wet.</p>	<p>Turn off, unplug and clean using instructions from "CLEANING & MAINTENANCE" section.</p>
Excessive noise.	<p>Too much dust has accumulated or internal parts are wet.</p>	<p>Clean and dry permanent ionic filter and pre-filter thoroughly. Keep the unit dry.</p>



WARRANTY

ONE YEAR LIMITED WARRANTY

Your Ionic Pro® Platinum air purifier is warranted to be free from defects in materials and workmanship for one year from the original purchase date. Should the product have a defect in materials or workmanship, we will repair or replace it without charge to you (a shipping and processing fee will apply). To obtain service under warranty, simply call our customer service center toll-free at **800.875.8577**.

This warranty does not cover damage caused by accident, misuse or any use other than as intended and described in this product manual, or damage resulting from failure to maintain and clean this product as specified in this product manual. This warranty applies only to the original purchaser of the Ionic Pro® Platinum air purifier.

ALL EXPRESS AND IMPLIED WARRANTIES FOR THIS PRODUCT, INCLUDING IMPLIED WARRANTIES OF MERCHANTABILITY AND FITNESS FOR A PARTICULAR PURPOSE, ARE LIMITED IN DURATION TO THE WARRANTY PERIOD, AND NO WARRANTIES, WHETHER EXPRESS OR IMPLIED, WILL APPLY AFTER THIS PERIOD.

Some states do not allow limitations on the duration of implied warranties, so the above limitation may not apply to you. While this warranty gives you specific legal rights, you may also have other rights which may vary from state to state.

CONTACT INFO FOR WARRANTY SERVICE:

Ionic Pro® by BONECO North America Corp.
P.O. Box 9169 | Van Nuys, CA | 91409
800.875.8577 | www.envion.com

©2020 BONECO North America Corp. All Rights Reserved.
Patents Pending.

The energy efficiency of this ENERGY STAR qualified model is measured based on a ratio between the model's CADR for Dust and the electrical energy it consumes, or CADR/Watt.



ARBITRATION AGREEMENT

PLEASE READ THIS AGREEMENT CAREFULLY. YOU ACCEPT THE TERMS OF THIS AGREEMENT BY RETAINING THE PRODUCT(S) SHIPPED IN CONNECTION WITH THIS AGREEMENT (THE "PRODUCTS") FOR MORE THAN THIRTY (30) DAYS AFTER RECEIPT. IF YOU DO NOT AGREE TO THE TERMS OF THIS AGREEMENT, YOU MAY RETURN THE PRODUCT TO COMPANY WITHIN THIRTY (30) DAYS OF RECEIPT FOR A FULL REFUND.

THIS ARBITRATION AGREEMENT ("AGREEMENT") AFFECTS YOUR LEGAL RIGHTS AND REMEDIES BY PROVIDING THAT DISPUTES BETWEEN YOU AND THE MANUFACTURER, DISTRIBUTOR AND/OR SELLER OF THIS PRODUCT (COLLECTIVELY, "COMPANY"), MUST BE RESOLVED THROUGH BINDING ARBITRATION AND NOT IN COURT. IT ALSO PROVIDES THAT ANY DISPUTE CANNOT BE RESOLVED IN A CLASS ACTION OR OTHER PROCEEDING WHERE YOU REPRESENT OTHER PERSONS OR OTHER PERSONS REPRESENT YOU, AND THAT NO CLASS OR REPRESENTATIVE ARBITRATIONS ARE PERMITTED. PLEASE CAREFULLY READ ALL TERMS IN THIS AGREEMENT.

- 1. RESOLUTION OF CLAIMS OR DISPUTES.** Any claim or dispute between you and Company (or any of Company's subsidiaries or affiliates) arising out of or relating in any way to the Product or this Agreement shall be resolved through final, binding arbitration. This arbitration obligation is reciprocally binding on both you and the Company and applies regardless of whether the claim or dispute involves a tort, fraud, misrepresentation, product liability, negligence, violation of a statute, or any other legal theory. Both you and Company specifically acknowledge and agree that you waive your right to bring a lawsuit based on such claims or disputes and to have such lawsuit resolved by a judge or jury.
- 2. LIMITATION OF LEGAL REMEDIES.** All arbitrations under this Agreement shall be conducted on an individual (and not a class-wide) basis, and an arbitrator shall have no authority to award class-wide relief. You acknowledge and agree that this Agreement specifically prohibits you and the Company from commencing arbitration proceedings as a representative of others or joining in any arbitration proceedings brought by any other person. The parties agree that no class or representative actions of any type are permitted.
- 3. ARBITRATION PROCEDURES.**
 - a. Before instituting an arbitration, if you have any dispute, we strongly encourage you to contact the Company to try to resolve the matter by calling 800.875.8577, although you are not required to do so.
 - b. The arbitration of any claim or dispute under this Agreement shall be conducted in accordance with the expedited procedures set forth in the JAMS Comprehensive Arbitration Rules and Procedures as those Rules exist on the date you receive the Product, including Rules 16.1 and 16.2 of those Rules. These rules and procedures are available by calling JAMS or by visiting its web site at www.jamsadr.com. The arbitration of any claim or dispute under this Agreement shall be conducted by an arbitrator who has at least five years of experience conducting arbitrations.
 - c. The arbitration of any claim or dispute under this Agreement shall be conducted in the State of California or the location in which you received this Agreement. For claims of \$10,000 or less, you may choose whether the arbitration proceeds in person, by telephone, or based only on submissions.
 - d. The Company shall pay costs for the arbitration of claims, including any JAMS Case Management Fee and all professional fees for the arbitrator's services. The Company shall pay the fees and costs of its own counsel, experts and witnesses and shall not be able to recoup them from you even if you do not prevail in the arbitration. Unless otherwise provided by law, you acknowledge and agree that you shall pay the fees and costs of your own counsel, experts and witnesses.
- 4. CHOICE OF LAW.** The arbitration provisions of this Agreement and any arbitration conducted pursuant to the terms of this Agreement shall be governed by the Federal Arbitration Act (9 U.S.C. Secs. 1-16). In this respect, the parties acknowledge that this Agreement involves a transaction conducted in interstate commerce. Otherwise, this Agreement and the rights of the parties hereunder shall be governed by and construed in accordance with the laws of the State of California, exclusive of conflict or choice of law rules.
- 5. SEVERABILITY.** If any provision of this Agreement is declared or found to be unlawful, unenforceable or void, such provision will be ineffective only to the extent that it is found unlawful, unenforceable or void, and the remainder of the provision and all other provisions shall remain fully enforceable.



