



220 ST STICK/TIG ARC WELDER OPERATING MANUAL



ENGLISH



**WELDING IN AMERICA.
SINCE THE BEGINNING.**



ITEM# 430
REV 08.08.2019



FIVE WAYS TO ORDER

Web: www.forneyind.com

Phone: 800-521-6038

Fax: 970-498-9505

Mail: Forney Industries
2057 Vermont Drive
Fort Collins, CO 80525

Email: sales@forneyind.com

U.S. Facilities:

- Fort Collins, CO
- Tipp City, OH



Copyright© 2019 Forney Industries, Inc. All rights reserved. Unauthorized reproduction and/or distribution is subject to US copyright laws.

Forney Promise

We are committed to your success regardless of location, size or needs. We understand it is your goal to get the job done right, and we are ready to help you do just that.

President's Message

We market the highest quality tools, equipment and accessories for the do-it-yourselfer and professional. Our passion and dedication in bringing new products to the industrial and retail market, combined with our personal service, is unmatched in our industry. Our ability to listen to our customers' needs enables us to create solutions to their problems.

Our dedication to the highest quality customer service within our corporate headquarters and the service provided in the field is unequalled. We are committed to creating the best solutions to our customer's needs. Above all, our employees will provide the same respect and caring attitude within the organization as they are expected to share with every Forney customer. Our goal will be to exceed our customers' expectations through empowered people, guided by shared values and commitments.

We work hard so our customers trust us because of our integrity, teamwork and innovation in the welding & metalworking industry. 80 years of unmatched product quality and an unwavering commitment to our customers.

When our customers succeed we succeed.

Steven G. Anderson

STEVEN G. ANDERSON, President & CEO



TECHNICAL ISSUES? FORNEY CAN HELP!

Thank you for choosing Forney! Please note: The store you purchased this machine from DOES NOT handle product returns. Forney Industries will repair or replace defective products at no charge to you!

When you call Forney's Technical Service department, you will speak to a trained product and application expert. Forney's primary goal is to get your machine up and running in as little time as possible. In fact, the majority of issues can be fixed over the phone! Please be near your machine when you call, so the Forney technician can guide you.

Speaking to a Forney Technician directly helps us gather better data, and improve our products. It is our highest priority to ensure our customers are cared for.



WE MAKE IT EASY!

Please contact Forney Industries Technical Service at 800-521-6038 x2 or customerservice@forneyind.com for inquires, technical and general questions.

Table of Contents





















WARRANTY.....	3
TABLE OF CONTENTS.....	4
SYMBOLS LEGEND.....	5
SAFETY SUMMARY	5
PRINCIPAL SAFETY STANDARDS	5
CALIFORNIA PROPOSITION 65 WARNING.....	6
EMF INFORMATION.....	6
PERSONAL PROTECTION	6
FIRE PREVENTION.....	7
HIGH FREQUENCY RADIATION.....	8
ARC WELDING	8
ELECTRIC SHOCK.....	8
NOISE	9
ADDITIONAL SAFETY INFORMATION	9
INSTALLATION.....	10
WELDER SPECIFICATIONS	10
SITE SELECTION	10
POWER SOURCE CONNECTION.....	10
GENERATORS.....	11
EXTENSION CORDS.....	11
VENTILATION	11
ADDITIONAL WARNINGS	11
GETTING TO KNOW YOUR WELDER.....	12
DESCRIPTION	12
WELDER LAYOUT AND CONTROLS	12
OPERATION.....	14
PERFORMANCE DATA PLATE & DUTY CYCLE	14
INTERNAL THERMAL PROTECTION	14
WELDING PREPARATION.....	15
SETUP FOR STICK WELDING (SMAW)	15
SETUP FOR TIG WELDING (GTAW) WITH LIFT ARC	16
GAS SELECTION.....	16
MAINTENANCE & SERVICING.....	17
GENERAL MAINTENANCE	17
TROUBLESHOOTING.....	17
MACHINE PARTS DIAGRAM & REPLACEMENT PARTS LIST	19
TIG TORCH & TIG CONSUMABLES LIST (SOLD SEPARATELY)	20
USER NOTES	21

CAUTION!

BEFORE INSTALLING, OPERATING OR CARRYING OUT MAINTENANCE ON THE MACHINE, READ THE CONTENTS OF THIS MANUAL CAREFULLY, PAYING PARTICULAR ATTENTION TO THE SAFETY RULES AND HAZARDS.

In the event of these instructions not being clear, please contact your Forney Authorized Dealer or Forney Customer Service 1-800-521-6038.

Symbols Legend

SYMBOL	MEANING	SYMBOL	MEANING	SYMBOL	MEANING
	ARC RAYS HAZARD		FIRE HAZARD		NOISE HAZARD
	POISON HAZARD		ELECTRICAL HAZARD		WARNING/CAUTION
	STICK (SMAW)		TIG (GTAW)		TEMPERATURE
	POSITIVE DINSE		INPUT VOLTAGE		AMPERAGE
	NEGATIVE DINSE			SINGLE PHASE STATIC FREQUENCY CONVERTER TRANSFORMER RECTIFIER	
	ON		LINE CONNECTION		DIRECT CURRENT (DC)
	OFF		SINGLE PHASE ALTERNATING CURRENT (AC)		SUITABLE FOR WELDING IN AN ENVIRONMENT WITH INCREASED RISK OF ELECTRIC SHOCK

Safety Summary

The data within this safety summary are highlights of various safety standards. It is recommended that you familiarize yourself with the standards listed below before beginning welding.

Principal Safety Standards

- ANSI Z49.1: SAFETY IN WELDING AND CUTTING - Obtainable from the American Welding Society, 550 NW Le Jeune Road, Miami, FL 33126 Telephone (800) 443-9353, Fax (305) 443-7559 - www.aws.org.
- OSHA 29 CFR, Part 1910, Subpart Q.: WELDING, CUTTING AND BRAZING - Obtainable from your state OSHA office or U.S. Dept. of Labor OSHA, Office of Public Affairs, Room N3647, 200 Constitution Ave., Washington, DC 20210 - www.osha.gov
- AWS F4.1: SAFE PRACTICES FOR THE PREPARATION FOR WELDING AND CUTTING OF CONTAINERS AND PIPING FOR WELDING AND CUTTING. - Obtainable from the American Welding Society, 550 NW Le Jeune Road, Miami, FL 33126 Telephone (800) 443-9353, Fax (305) 443-7559 - www.aws.org.
- AWS A6.0. WELDING AND CUTTING CONTAINERS WHICH HAVE HELD COMBUSTIBLES - Obtainable from the American Welding Society, 550 NW Le Jeune Road, Miami, FL 33126 Telephone (800) 443-9353, Fax (305) 443-7559 - www.aws.org.
- NFPA 70: NATIONAL ELECTRICAL CODE - Obtainable from the National Fire Protection Association, 1 Batterymarch Park, P.O. Box 9101, Quincy, MA 02269-9101 Telephone (617) 770-3000 Fax (617) 770-0700 - www.nfpa.org
- CGA Publication P-1: SAFE HANDLING OF COMPRESSED GASES IN CONTAINERS - Obtainable from Compressed Gas Association, 14501 George Carter Way, Suite 103, Chantilly, VA 20151 Telephone (703) 788-2700 Fax (703) 961-1831 - www.cganet.com
- CSA W117.2 - Code for SAFETY IN WELDING AND CUTTING. - Obtainable from Canadian Standards Association, 178 Rexdale Blvd., Etobicoke, Ontario M9W 1R3 - www.csa.ca
- ANSI Z87.1 - SAFE PRACTICE FOR OCCUPATION AND EDUCATIONAL EYE AND FACE PROTECTION - Obtainable from the American National Standards Institute, 11 West 42nd St., New York, NY 10036 Telephone (212) 642-900, Fax

(212) 398-0023 - www.ansi.org

- NFPA 51B: STANDARD FOR FIRE PREVENTION DURING WELDING, CUTTING, AND OTHER HOT WORK- Obtainable from the National Fire Protection Association, 1 Batterymarch Park, P.O. Box 9101, Quincy, MA 02269-9101 Telephone (617) 770-3000 Fax (617) 770-0700 - www.nfpa.org

California Proposition 65 Warning

⚠ WARNING: This product can expose you to chemicals, including lead, which are known to the State of California to cause cancer and birth defects or other reproductive harm. For more information go to www.P65Warnings.ca.gov. P65 details at forneyind.com. Wash hands after use.

EMF Information

Welding current, as it flows through the welding cables, will cause electromagnetic fields. There has been and still is some concern about such fields. However, after examination, the committee of the National Research Council concluded that: "The body of evidence, in the committee's judgment, has not demonstrated that exposure to power-frequency electric and a magnetic field is a human health hazard." However, studies are still going forth and evidence continues to be examined. Until the final conclusions of the research are reached, you may wish to minimize your exposure to electromagnetic fields when welding.

To reduce magnetic fields in the workplace, use the following procedures:

1. Keep electrode and ground cables close together by twisting or taping them when possible.
2. Arrange cables to one side and away from the operator.
3. Do not coil or drape cables around your body.
4. Keep welding power source and cables as far away from operator as practical.
5. Connect ground clamp to workpiece as close to the cut or weld as possible.

ABOUT PACEMAKERS & HEARING AIDS:

Pacemaker and hearing aid wearers consult your doctor first. If cleared by your doctor, then following the above procedures is recommended.

Personal Protection

Welding processes of any kind can be dangerous not only to the operator but to any person situated near the equipment, if safety and operating rules are not strictly observed.



THE WELDING ARC PRODUCES VERY BRIGHT ULTRAVIOLET AND INFRARED LIGHT. THESE ARC RAYS WILL DAMAGE YOUR EYES AND BURN YOUR SKIN IF YOU ARE NOT PROPERLY PROTECTED.

To reduce the risk of injury from arc rays, read, understand, and follow the safety instructions. In addition, make certain that anyone else that uses this welding equipment, or is a bystander in the welding area understands and follows these safety instructions as well. Helmets and filter should conform to ANSI Z87.1 standards.

- Do not look at an electric arc without proper protection. A welding arc is extremely bright and intense and, with inadequate or no eye protection, the retina can be burned, leaving a permanent dark spot in the field of vision. A shield or helmet with a #10 shade filter lens (minimum) must be used.
- Provide bystanders with shields or helmets fitted with an appropriate shade filter lens.
- Do not strike a welding arc until all bystanders and you (the welder) have welding shields and/or helmets in place.
- Do not wear a cracked or broken helmet and replace any cracked or broken filter lenses immediately.
- Do not allow the uninsulated portion of the TIG torch to touch the ground clamp or grounded workpiece to prevent an arc flash from being created on contact.
- Wear protective clothing. The intense light of the welding arc can burn the skin in much the same way as the sun, even through lightweight clothing. Wear dark clothing of heavy material. The shirt worn should be long sleeved and the collar kept buttoned to protect chest and neck.
- Protect against reflected arc rays. Arc rays can be reflected off shiny surfaces such as a glossy painted surface, aluminum, stainless steel, and glass. It is possible for your eyes to be injured by reflected arc rays even when wearing a protective helmet or shield. If welding with a reflective surface behind you, arc rays can bounce off the surface and off the filter lens. It can get inside your helmet or shield and into your eyes. If a reflective background exists in your welding area, either remove it or cover it with something non-flammable and non-reflective. Reflective arc rays can also cause skin burn in addition to eye injury.

- Flying sparks can injure. Wear proper safety equipment to protect eyes and face. Shape tungsten electrode on grinder wearing proper protection and in a safe location. Keep flammables away and prevent fire from flying sparks.



FUMES, GASSES, AND VAPORS CAN CAUSE DISCOMFORT, ILLNESS, AND DEATH! To reduce the risk, read, understand, and follow the safety instructions. In addition, make certain that anyone else that uses this welding equipment or is a bystander in the welding area, understands and follows these safety instructions as well.

- Read and understand manufacturers Safety Data Sheets (SDS) and Material Safety Data Sheets (MSDS).
- Do not weld in an area until it is checked for adequate ventilation as described in ANSI standard Z49.1. If ventilation is not adequate to exchange all fumes and gasses generated during the welding process with fresh air, do not weld unless you (the welder) and all bystanders are wearing air-supplied respirators.
- Do not heat metals coated with, or that contain, materials that produce toxic fumes (such as galvanized steel), unless the coating is removed. Make certain the area is well ventilated, and the operator and all bystanders are wearing air-supplied respirators.
- Do not weld, cut or heat lead, zinc, cadmium, mercury, beryllium, antimony, cobalt, manganese, selenium, arsenic, copper, silver, barium, chromium, vanadium, nickel, or similar metals without seeking professional advice and inspection of the ventilation of the welding area. These metals produce extremely toxic fumes which can cause discomfort, illness and death.
- Do not weld or cut in areas that are near chlorinated solvents. Vapors from chlorinated hydrocarbons, such as trichloroethylene and perchloroethylene, can be decomposed by the heat of an electric arc or its ultraviolet radiation. These actions can cause phosgene, a highly toxic gas to form, along with other lung and eye-irritating gasses. Do not weld or cut where these solvent vapors can be drawn into the work area or where the ultraviolet radiation can penetrate to areas containing even very small amounts of these vapors.
- Do not weld in a confined area unless it is being ventilated or the operator (and anyone else in the area) is wearing an air-supplied respirator.
- Stop welding if you develop momentary eye, nose, or throat irritation as this indicates inadequate ventilation. Stop work and take necessary steps to improve ventilation in the welding area. Do not resume welding if physical discomfort persists.

Fire Prevention



FIRE OR EXPLOSION CAN CAUSE DEATH, INJURY, AND PROPERTY DAMAGE! To reduce these risks, read, understand and follow the safety instructions. In addition, make certain that anyone else that uses this welding equipment, or is a bystander in the welding area, understands and follows these safety instructions as well. Remember: arc welding by nature produces sparks, hot spatter, molten metal drops, hot slag and hot metal parts that can start fires, burn skin and damage eyes.

- Do not wear gloves or other clothing that contains oil, grease, or other flammable substances.
- Do not wear flammable hair preparations.
- Do not touch the hot weld bead or weld puddle until fully cooled.
- Do not weld in an area until it is checked and cleared of combustible and/or flammable materials. Be aware that sparks and slag can fly 35 feet and can pass through small cracks and openings. If work and combustibles cannot be separated by a minimum of 35 feet, protect against ignition with suitable, snug-fitting, fire resistant, covers or shields.
- Do not weld on walls until checking for and removing combustibles touching the other side of the walls.
- Connect the ground cable to the workpiece as close as possible to the welding area. Do not connect ground cables to building framing or other locations away from the welding area. This increases the possibility of welding current passing through alternate circuits, creating fire hazards and other safety hazards.
- Do not weld, cut, or perform other such work on used barrels, drums, tanks, or other containers that had a flammable or toxic substance. The techniques for removing flammable substance and vapors, to make a used container safe for welding or cutting, are quite complex and require special education and training.
- Do not strike an arc on a compressed gas or air cylinder, and never allow any electrically "hot" parts to touch a cylinder. Doing so will create a brittle area that can result in a violent rupture immediately or at a later time as a result of rough handling.
- Ensure any compressed gas cylinders in the work area have properly operating regulators rated for the gas and pressure used. All hoses, fittings, etc. should be in good condition.
- Do not stand in front of or put your head or face in front of a cylinder valve outlet when opening the valve.
- If a cylinder is not in use or connected for use, keep a valve protection cap in place to protect the valve.
- Keep cylinders upright and securely chain them to a fixed support to prevent tipping.

- Keep cylinders away from areas where they may be subjected to physical damage or accidentally struck. Keep them a safe distance from any source of flame, sparks, or heat.
- Do not weld or cut in an area where the air may contain flammable dust (such as grain dust), gas, or liquid vapors (such as gasoline).
- Do not handle hot metal, such as the workpiece or electrode stubs, with bare hands.
- Wear leather gloves, heavy long sleeve shirt, cuff-less pants, high-topped shoes, helmet, and cap. As necessary, use additional fire-resistant protective clothing to cover and protect the upper and lower body. Hot sparks or metal can lodge in rolled up sleeves, pant cuffs, or pockets. Sleeves and collars should be kept buttoned and pockets eliminated from the shirt front.
- Have fire extinguisher equipment handy for immediate use. A portable chemical fire extinguisher, type ABC, is recommended.
- Wear ear plugs when welding overhead to prevent spatter or slag from falling into ear.
- Make sure welding area has a good, solid, safe floor, preferably concrete or masonry, not tiled, carpeted, or made of any other flammable material.
- Protect flammable walls, ceilings, and floors with heat resistant covers or shields.
- Check welding area to make sure it is free of sparks, glowing metal or slag, and flames before leaving the welding area.
- Wear garments free of oil or other flammable substances such as leather gloves, thick cotton shirts with no synthetic materials, cuffless trousers, closed toed shoes. Keep long hair pulled back.
- Remove any combustibles such as lighters and matches before doing any welding.
- Follow requirements in OSHA and NFPA for hot work and have an extinguisher nearby.

High Frequency Radiation

- High Frequency (H.F) can interfere with radio navigation, safety services, computers and communication equipment.
- It is the user's responsibility to have a qualified electrician promptly correct any interference problem resulting from the installation. Electrician should regularly check and maintain installation.
- Stop using the equipment if notified by the FCC about interference.
- Keep H.F. source doors and panels tightly shut and keep spark gaps at correct setting.

Arc Welding

- Computers and computer driven equipment can be harmed with electromagnetic energy.
- Be sure all equipment is compatible with electromagnetic energy.
- Keep welding cables short to reduce interference.
- Follow manual to install and ground machine.
- If interference continues, shield the work area or move the welding machine.

Electric Shock



WARNING: ELECTRIC SHOCK CAN KILL! To reduce the risk of death or serious injury from shock, read, understand, and follow the safety instructions. In addition, make certain that anyone else who uses this welding equipment, or who is a bystander in the welding area understands and follows these safety instructions as well.

IMPORTANT! TO REDUCE THE RISK OF DEATH, INJURY, OR PROPERTY DAMAGE, DO NOT ATTEMPT OPERATION of this welding equipment until you have read and understand the following safety summary.

- Do not, in any manner, come into physical contact with any part of the welding current circuit. The welding current circuit includes:
 - a. the workpiece or any conductive material in contact with it,
 - b. the ground clamp,
 - c. the electrode or welding wire,
 - d. any metal parts on the electrode holder, or TIG torch.
- Do not weld in a damp area or come in contact with a moist or wet surface.
- Do not attempt to weld if any part of clothing or body is wet.
- Do not allow the welding equipment to come in contact with water or moisture.

- Do not drag welding cables, TIG torch, electrode holder or welder INPUT POWER CABLE (8) through or allow them to come into contact with water or moisture.
- Do not touch welder, attempt to turn welder ON or OFF if any part of the body or clothing is moist or if you are in physical contact with water or moisture.
- Do not attempt to plug the welder into the power source if any part of body or clothing is moist, or if you are in physical contact with water or moisture.
- Do not connect ground clamp to electrical conduit, and do not weld on electrical conduit.
- Do not alter INPUT POWER CABLE or plug in any way.
- Do not attempt to plug the welder into the power source if the ground prong on INPUT POWER CABLE plug is bent over, broken off, or missing.
- Do not allow the welder to be connected to the power source or attempt to weld if the welder, welding cables, welding site, or welder INPUT POWER CABLE are exposed to any form of atmospheric precipitation, or salt water spray.
- Do not carry coiled welding cables around shoulders, or any other part of the body, when they are plugged into the welder.
- Do not modify any wiring, ground connections, switches, or fuses in this welding equipment.
- Wear welding gloves to help insulate hands from welding circuit.
- Keep all liquid containers far enough away from the welder and work area so that if spilled, the liquid cannot possibly come in contact with any part of the welder or electrical welding circuit.
- Replace any cracked or damaged parts that are insulated or act as insulators such as welding cables, INPUT POWER CABLE, or electrode holder immediately.
- When not welding, cut wire back to contact tip or remove electrode from electrode holder.

Noise



Noise can cause permanent hearing loss. Welding processes can cause noise levels that exceed safe limits. You must protect your ears from loud noise to prevent permanent loss of hearing.

- To protect your hearing from loud noise, wear protective ear plugs and/or ear muffs.
- Noise levels should be measured to be sure the decibels (sound) do not exceed safe levels.

Additional Safety Information

For additional information concerning welding safety, refer to the standards listed at the beginning of this safety summary and comply with them as applicable.

Installation

Welder Specifications

Primary (Input) Volts	230/120VAC
Maximum Output	220A (DC output only)
Phase	Single
Frequency	50/60Hz
Recommended Circuit Breaker	50A for 230V or 30A for 120V
Extension Cord Recommendations	230V- 3 conductor # 8 AWG 120V -3 conductor #12 AWG or larger up to 25 ft.
Generator Requirements	230V -Minimum 10,000W continuous output with no low-idle function (or low-idle off), 5% THD Max. 120V- Minimum 5,000W continuous output with no low-idle function (or low-idle off), 5% THD Max.
CSA Rated Output and Duty Cycle	Refer to the data plate of your machine and the DUTY CYCLE section of this manual, page 14.
Dimensions	17.5" (444.5mm) X 7" (177.8mm) X 12.5" (317.5mm)
Recommended Electrode Diameter	Up to 3/16" (depending on type)

Site Selection



BE SURE TO LOCATE THE WELDER ACCORDING TO THE FOLLOWING GUIDELINES:

- In areas free from moisture and dust;
- In areas with ambient temperature between 30° to 90°F;
- In areas free from oil, steam and corrosive gases;
- In areas not subjected to abnormal vibration or shock;
- In areas not exposed to direct sunlight or rain;
- Place at a distance of 12" or more from walls or similar obstructions that could restrict natural air flow for cooling.

Power Source Connection

Before you make any electrical connection, make sure that the ON/OFF SWITCH is OFF, power supply voltage and frequency available at site are those stated in the ratings label of your welder.

The main power supply voltage should be within $\pm 10\%$ of the rated main power supply voltage. Too low a power supply voltage may cause poor welding performance. Too high a power supply voltage will cause components to overheat and possibly fail. The welder outlet must be

- Correctly installed, if necessary, by a qualified electrician;
- Correctly grounded (electrically) in accordance with national and local regulations;
- Connected to an electric circuit that is rated for sufficient amperage per the ratings label of your welder.

If you are unsure of any of the above, have your outlet inspected by a qualified electrician before using the welder.

NOTE:

- Periodically inspect INPUT POWER CABLE for any cracks or exposed wires. If it is not in good condition, have it repaired by a Service Center.
- Do not cut off the grounding prong or alter the plug in any way. Only use the included adapter between the welder's INPUT POWER CABLE and the power source receptacle.
- Do not violently pull the INPUT POWER CABLE to disconnect it from power outlet.
- Do not lay material or tools on the INPUT POWER CABLE. The INPUT POWER CABLE may be damaged and result in electrical shock.
- Keep the INPUT POWER CABLE away from heat sources, oils, solvents or sharp edges.
- Do not use this welder on a circuit with a Ground Fault Circuit Interrupter (GFCI) on it. GFCIs are tripped by welding arcs and your welding operations will be interrupted regularly.

Using the 230 volt – 120 volt Plug Adapter

If a 230V (50A) circuit is not available, you can connect your 220 ST PRO Forney welder to 20A outlet (with a 30A breaker) using the plug adapter. When using the plug adapter, use lower power settings on the machine to avoid frequent circuit breaker trips. At maximum settings on 120V, the machine will draw more than 20 amps regularly.

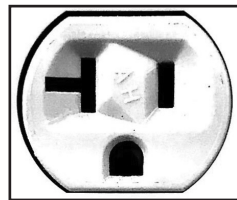

120V/20A



230V/50A

Generators

This welder can be operated from an AC generator. As this is a dual voltage machine please ensure that when using on 230V, the generator must supply a minimum of 10,000 watts of continuous output. When using the 120V option, the generator must supply a minimum of 5,000 watts of continuous output. The generator must not have an auto-idle fuel saving feature or must have the option to turn auto-idle off. The generator must run at full speed at all times while your welder is plugged into it or you risk damaging your welder. Any other power draws on the generator or anything that reduces the generator RPM may damage your welder.

Extension Cords

For optimum welder performance, an extension cord should not be used unless absolutely necessary. If necessary, care must be taken in selecting an extension cord appropriate for use with your specific welder.

Select a properly grounded extension cord that will mate directly with the AC power source receptacle and the welder INPUT POWER CABLE without the use of adapters. Make certain that the extension cord is properly wired and in good electrical condition. Extension cords must fit the following wire size guidelines:

- #8 AWG for 230V-3 conductor.
- #12 AWG for 120V-3 conductor.
- Do not use an extension cord over 25 ft. in length.

Ventilation

Since the inhalation of welding fumes can be harmful, ensure that the welding area is effectively ventilated. See the "Safety Summary" for more details (pages 5-9).

Additional Warnings

FOR YOUR SAFETY, BEFORE CONNECTING THE POWER SOURCE TO THE LINE CLOSELY FOLLOW THESE INSTRUCTIONS:

- An adequate two-pole breaker must be inserted before the main outlet. This breaker must be equipped with time-delay fuses.
- When working in a confined space, the welder must be kept outside the welding area and the ground cable should be fixed to the workpiece. Never work in a damp or wet confined space.
- Do not use damaged INPUT POWER CABLE or welding cables.
- The welding torch/electrode should never be pointed at the operator or other people.
- The welder must never be operated without its panels attached. This could cause serious injury to the operator and could damage the equipment.

Getting to Know Your Welder

Description

Your new single phase inverter welder offers Stick and TIG welding processes in the same power source. These processes can be selected with the process SELECTOR BUTTON (1) on the front panel of the unit.

Stick Welding, "SMAW"

All electrode types can be used. Welding current is adjusted using the AMPERAGE ADJUSTMENT KNOB (4).

TIG Welding, "GTAW"

In the TIG position, a TIG torch with a gas valve in the handle is NOT required. The gas valve is automatically turned on when pedal is pushed or amp trol is engaged. The arc is activated using a lift arc technique or high frequency start technique.

Using the AMPERAGE ADJUSTMENT KNOB, maximum welding current can be adjusted.

Welder Layout and Controls

1. **PROCESS SELECT SWITCH** for welding process selection
 - a. DC TIG HF – Direct Current TIG High Frequency (automatic start when pedal or torch button engaged)
 - b. DC TIG LIFT- Direct Current TIG automatic start when touch and lifted to create arc
 - c. DC STICK - Direct Current Stick welding
2. **THERMAL FAULT LED** - thermal overload protection has been activated
3. **INPUT VOLTAGE LED** – machine is powered on and operating normally
4. **OUTPUT FAULT LED** – there is a general welding or machine fault
5. **SECONDARY PARAMETER KNOB/SELECTOR** for the function selection:
 - a. PULSE (Hz)- Frequency: Pulses per second or Hertz
 - b. PULSE (% On) – Balance: % at Peak Amperage Peak
 - c. ARC FORCE – Affects penetration while also modifying arc from soft to hard.
6. **AMPERAGE ADJUSTMENT KNOB is used to adjust the following welding parameters:**

Using 120V

 - a. In STICK ("SMAW") Mode it adjusts welding current (amperage) from 15A to 80A.
 - b. In TIG, ("GTAW") Mode it adjusts welding current (amperage) from 10A to 85A.

Using 230V

 - a. In STICK ("SMAW") Mode it adjusts welding current (amperage) from
 - b. In TIG, ("GTAW") Mode it adjusts welding current (amperage) from
7. **POSITIVE (+) DINSE SOCKET**
8. **TIG GAS OUTPUT**
9. **NEGATIVE (-) DINSE SOCKET**
10. **ACCESSORY CONNECTION**
11. **POWER SWITCH**
12. **INPUT POWER CABLE**
13. **TIG GAS INPUT**
14. **FANS**

Advanced Function Selection Details

1. **PULSE (Hz)** Changes how often amperage switches between Base Current and Peak (High) Current per second. A higher PPSulse setting creates focused puddle and tight ripple bead pattern. A lower PPS creates broader puddle and unique ripple bead pattern.
2. **PULSE (% On)** changes the amount of time the pulse stays at Main (Peak) current. A higher Pulse (% On) will increase penetration while a lower value is better for thin material.
3. **ARC FORCE** changes penetration and adjusts arc from soft (low) to hard (high).

REAR VIEW OF FORNEY 220 ST PRO WELDER

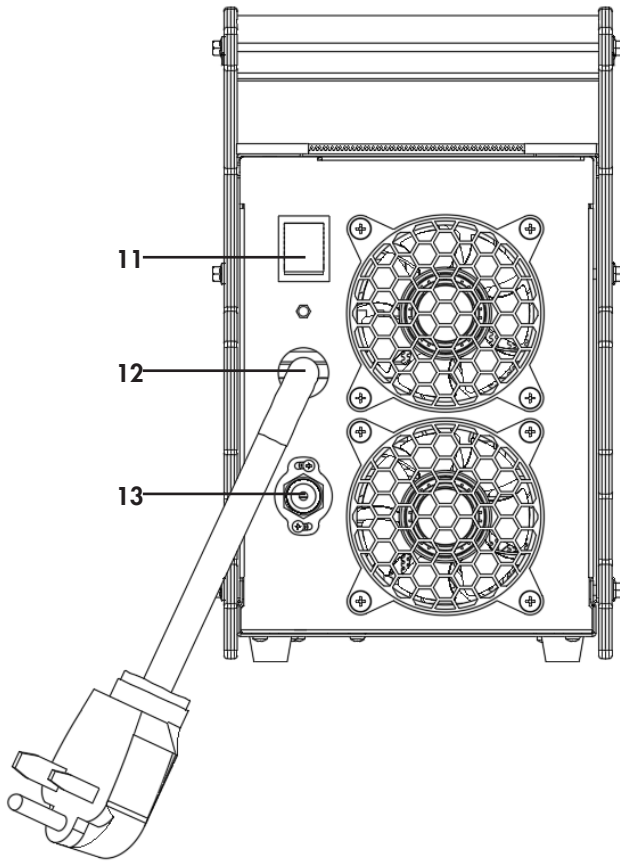

FRONT VIEW OF FORNEY 220 ST PRO WELDER

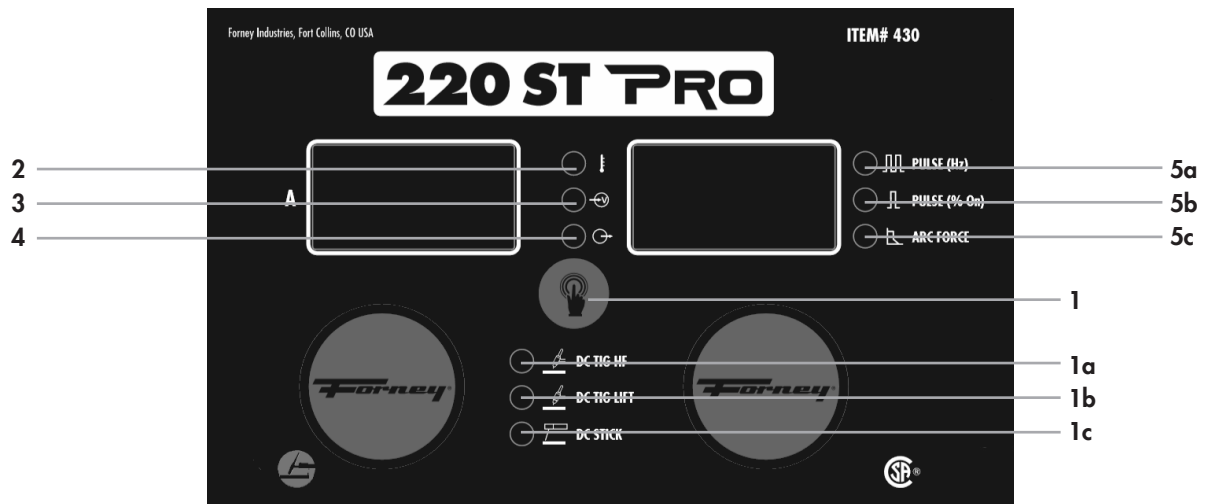
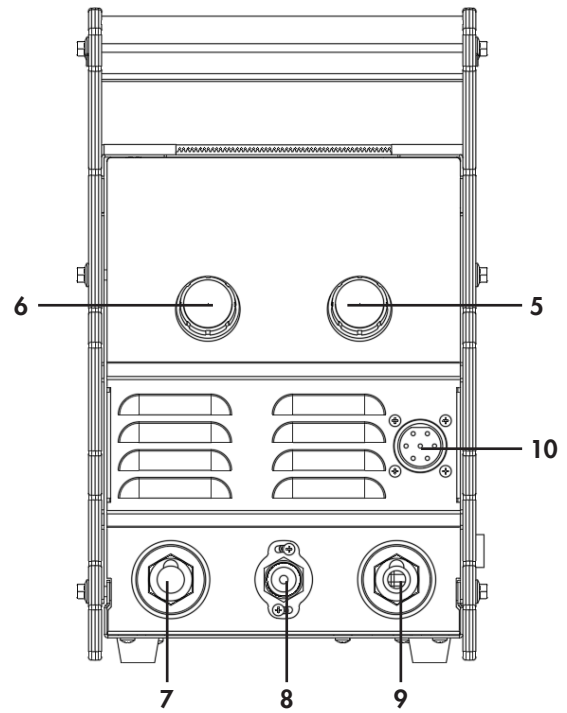











Operation

Performance Data Plate and Duty Cycle

On the machine, there is a plate that includes all the operating specifications for your new unit. The serial number of the product is also found on this plate.

The duty cycle rating of a welder defines how long the operator can weld and how long the welder must rest and be cooled. Duty cycle is expressed as a percentage of 10 minutes and represents the maximum welding time allowed. The balance of the 10-minute cycle is required for cooling.

For example, a welder has a duty cycle rating of 30% at the rated output of 90A. This means with that machine, you can weld at 90 A output for three (3) minutes out of 10 with the remaining seven (7) minutes required for cooling. The duty cycle of your new welder can be found on the data plate affixed to the machine. It looks like the diagram below. Referring to the sample below, the "X" row lists duty cycle percentages while the "I2" row lists the amp draw corresponding to the duty cycle. Various duty cycles at other amperages are listed on your data plate

220 ST PRO		SER #:			
					
		min #A/min #V – max #A/max #V			
		X	Y%	Z%	100%
	U _o =##.#V	I ₂	##A	##A	##A
		U ₂	##.#V	##.#V	##.#V
 1~50/60Hz	U ₁ =###V		I _{1max} =##.#A		I _{1eff} =##.#A
		min #A/min #V – max #A/max #V			
		X	Y%	Z%	100%
	U _o =##.#V	I ₂	##A	##A	##A
		U ₂	##.#V	##.#V	##.#V
 1~50/60Hz	U ₁ =###V		I _{1max} =##.#A		I _{1eff} =##.#A
IP21S					

(Example Data Plate)

Internal Thermal Protection

If you exceed the duty cycle of the welder, the thermal protection system will engage, shutting off all welder output. After cooling, the thermal protector will automatically reset and the welding functions can resume. This is normal and automatic behavior of the machine, and does not require any user action. However, you should wait at least ten minutes after the thermal protector engages before resuming welding. You must do this even if the thermal protector resets itself before the ten minutes is up or you may experience less than specified duty cycle performance.

CAUTION: DO NOT REGULARLY EXCEED THE DUTY CYCLE OR DAMAGE TO THE WELDER CAN RESULT.

Welding Preparation

An important factor in making a satisfactory weld is preparation. This includes studying the process and equipment and practicing welding before attempting to weld finished product. An organized, safe, ergonomic, comfortable, and well-lit work area should be prepared for the operator. The work area should specifically be free of all flammables with both a

fire extinguisher and a bucket of sand available.

To properly prepare for welding with your new welder, it is necessary to:

- Read the safety precautions at the front of this manual.
- Prepare an organized, well-lit work area.
- Provide protection for the eyes and skin of the operator and bystanders.
- Attach the ground clamp to the bare metal to be welded, making sure of good contact.
- Make sure that the wire-roller groove in the roller corresponds to the diameter and type of wire being used.
- Plug the machine into a suitable outlet.
- Completely open the gas cylinder valve. Adjust the gas pressure regulator to the correct flow rate. (Not applicable to Stick "SMAW" process).



EXPOSURE TO A WELDING ARC IS EXTREMELY HARMFUL TO THE EYES AND SKIN. PROLONGED EXPOSURE TO A WELDING ARC CAN CAUSE BLINDNESS AND BURNS. NEVER STRIKE AN ARC OR BEGIN WELDING UNLESS YOU ARE ADEQUATELY PROTECTED. WEAR FIRE RESISTANT WELDING GLOVES, HEAVY LONG SLEEVED SHIRT, CUFFLESS PANTS; HIGH TOPPED SHOES AND A WELDING HELMET.

Setup for Stick Welding (SMAW)



- Press the Process SELECTOR BUTTON on the front panel to the left position.
- Check the electrode packaging to determine the recommended polarity and connect the electrode holder and ground clamp to the POSITIVE (+) and NEGATIVE (-) DINSE SOCKETS accordingly.
- Direct current electrode positive (DCEP) or direct current reverse polarity (DCRP): electrode holder in POSITIVE (+) DINSE SOCKET, ground clamp in NEGATIVE (-) DINSE SOCKET. Most electrodes use DCEP.
- Direct current electrode negative (DCEN) or direct current straight polarity (DCSP): electrode holder in NEGATIVE (-) DINSE SOCKET, ground clamp in POSITIVE (+) DINSE SOCKET
- Ensure the ground clamp has a good connection to the workpiece and is connected on clean, bare metal (not rusty or painted).
- Secure the bare end of the welding electrode in-to the jaws of the electrode holder.
- Switch the unit ON with the ON/OFF SWITCH
- Set parameters with the SECONDARY PARAMETER KNOB/SELECTOR.
- Set the amperage with the AMPERAGE ADJUSTMENT KNOB.

Setup for Stick Welding (SMAW)

220 ST PRO STICK SET-UP CHART

STICK (SMAW)	Electrode Type	E6010		E6011		E6013		E7014		E7018		E308L/E309L/E316L	
	Electrode Diam	Amperage	Polarity	Amperage	Polarity	Amperage	Polarity	Amperage	Polarity	Amperage	Polarity	Amperage	Polarity
	1/16" (1.6mm)	N/A	DCEP	N/A	AC-DCEP	20-45	AC-DCEP-DCEN	N/A	AC-DCEP-DCEN	N/A	DCEP	20-40	DCEP
	3/32" (2.4mm)	30-75	DCEP	40-85	AC-DCEP	40-90	AC-DCEP-DCEN	70-90	AC-DCEP-DCEN	65-100	DCEP	40-70	DCEP
	1/8" (3.2mm)	75-125	DCEP	75-125	AC-DCEP	70-110	AC-DCEP-DCEN	90-140	AC-DCEP-DCEN	110-165	DCEP	75-115	DCEP
	5/32" (4.0mm)	110-165	DCEP	110-165	AC-DCEP	115-140	AC-DCEP-DCEN	140-190	AC-DCEP-DCEN	150-220	DCEP	105-160	DCEP

Setup for TIG Welding (GTAW) with Lift Arc



Setting up the Equipment for TIG Welding (GTAW):

Lanthanated Tungsten recommended for use.



WARNING: TIG TORCH IS ALWAYS LIVE (ELECTRICALLY HOT).

Use caution and ensure the TIG torch is not in contact with or near conductive or grounded materials.

- Connect the TIG torch cable to the NEGATIVE (-) DINSE SOCKET (9) of the welder.
- Connect the ground cable connector to the POSITIVE (+) DINSE SOCKET (7) of the welder.
- Ensure the ground clamp has a good connection to the workpiece and is connected on clean, bare metal (not rusty or painted).
- Connect the TIG torch gas line to the gas regulator (argon gas or argon/helium).

INERT GAS (ARGON OR ARGON/HELIUM) ONLY.

TURN ON GAS AT THE GAS REGULATOR, CHECK FOR GAS FLOW AND ADJUST FLOW RATE AS NEEDED.

- Fix the tungsten electrode so that it protrudes approximately 1/4 inch from the torch nozzle.
- Ensure the TIG torch is safely away from all conductive materials.
- Switch the unit ON with the ON/OFF SWITCH.
- Press the Process SELECTOR BUTTON (1) on the front panel to the correct position.
- Set parameters with the SECONDARY PARAMETER KNOB/SELECTOR.
- Set the amperage with the AMPERAGE ADJUSTMENT KNOB.
- Press pedal or torch button and gas will flow.
- Initiate the weld arc.
- Use pedal or torch to adjust output amperage while working.

REMEMBER TO CLOSE THE VALVE ON THE GAS CYLINDER IMMEDIATELY AFTER ALL WELDING IS COMPLETED.

220 ST PRO TIG SET-UP CHART

TIG (GTAW)	Polarity	Material Thickness	1/16" (1.6mm)				3/32" (2.4mm)				1/8" (3.2mm)				3/16" (4.8mm)			
			Filler Diameter	Amperage	Gas Cup	Tungsten Diam	Filler Diameter	Amperage	Gas Cup	Tungsten Diam	Filler Diameter	Amperage	Gas Cup	Tungsten Diam	Filler Diameter	Amperage	Gas Cup	Tungsten Diam
100% Argon	DCEN	DCEN -Recommend 2% Ceriated Tungsten	1/16" (1.6mm)	50-80	3/8" (#6)	1/16" (1.6mm)	1/16" (1.6mm)	80-110	3/8" (#6)	1/16" (1.6mm)	3/32" (2.4mm)	85-120	3/8" (#6)	1/16" (1.6mm)	1/8" (3.2mm)	125-200	7/16" (#7)	3/32" (2.4mm)

Welding Tips:

- Always weld clean, dry and well-prepared material.
- Move the torch smoothly and steadily as you weld.
- Avoid welding in very drafty areas. A weak, pitted and porous weld will result due to drafts blowing away the protective welding gas.
- Sharp bends or kinks in the welding cable should be avoided.
- The diameter of the welding electrode should be approximately the same as the thickness of the metal to be welded.
- The packaging of the welding electrode typically gives a recommended range for the welding current. Set the amperage accordingly.

Gas Selection

Use 100% argon gas when TIG welding with mild steel or stainless steel.

NOTE: THIS MACHINE IS NOT AN APPROPRIATE POWER SOURCE FOR WELDING ALUMINUM.

Accessory Connection Guide

This machine has a 7-pin Amphenol™ style connection for connecting accessories 16

- Foot Pedal (adjusts amperage) – attach TIG torch to negative Dinse™ terminal and then plug in 7-pin foot pedal connector.
 - Double check the TIG process is selected.
 - Set desired maximum current on the machine.
 - Use pedal to fine control amperage.
- Amperage controlled TIG torch – attach TIG torch to negative Dinse™ terminal and then plug in 7-pin connector.
 - Double check the TIG process is selected.
 - Set desired maximum current on the machine.
 - Use roller wheel on the TIG torch to fine control amperage.

Tungsten Recommendations

TUNGSTEN TYPE	COMMENTS
1.5-2% Lanthanated (La)	Most versatile tungsten (best overall)
1.5-2% Ceriated (Ce)	Solid performance for most applications
1-2% Thoriated (Th)	Performance OK but hazardous
Pure	Ok but will ball up and not allow concentrated arc

Recommended Amperage Settings for SMAW (Arc) Electrodes

SIZE OF WELDING ELECTRODE	AMPERAGE SETTING
1 / 16" – 16 Gauge	30-40
5 / 64" – 14 Gauge	50-65
3 / 32"	70-100
1 / 8 "	100-140
5 / 32"	140-180
3 / 16"	150-200

Recommended Amperage & Electrode Types for TIG Welding

TUNGSTEN	DCEN (Th,La,Ce)	AC (La,Ce)	AC (Pure)
.040"	10-50A	20-40A	N/A
1 / 16"	40-120A	30-170A	30-90A
3 / 32"	90-200A	60-180A	40-120A
1 / 8"	150A+	130A+	100-200A

Maintenance & Servicing

General Maintenance

This welder has been engineered to need minimal service providing that a few very simple steps are taken to properly maintain it.

1. Replace INPUT POWER CABLE, ground cable, ground clamp, or torch/electrode cable when damaged or worn.
2. Avoid directing grinding particles towards the welder. These conductive particles can build up inside the machine and cause severe damage.
3. Periodically clean dust, dirt, grease, etc. from your welder. Every six months or as necessary, remove the side panels from the welder and use compressed air to blow out any dust and dirt that may have accumulated inside the welder.



WARNING: DISCONNECT FROM POWER SOURCE WHEN CARRYING OUT THIS OPERATION.

4. Check all cables periodically. They must be in good condition and not cracked.



WARNING: ELECTRIC SHOCK CAN KILL! ! Be aware that the ON/OFF SWITCH, when OFF, does not remove power from all internal circuitry in the welder. To reduce the risk of electric shock, always unplug the welder from its AC power source and wait several minutes for electrical energy to discharge before removing side panels.

Troubleshooting

The following is a troubleshooting table provided to help you determine a possible remedy when you are having a problem with your welder.

This table does not provide all possible solutions, only those possibilities considered likely to be common faults.

PROBLEM	POSSIBLE CAUSE	POSSIBLE SOLUTION
All LEDs OFF, No output power, Fan not operating.	No input power.	Connect machine to proper input power source. Verify that circuit breaker has not been tripped in your main power panel. Reset if needed.
	POWER SWITCH is OFF.	Ensure POWER SWITCH (rear) is in the ON position.
FAULT CODE F01 DISPLAYED	Exceeded duty cycle; thermal protector engaged.	Allow welder to cool at least 10 minutes with machine ON (observe and maintain proper duty cycle). FAULT/THERMAL OVERLOAD INDICATOR LED should
	Insufficient air flow causing machine to overheat before reaching duty cycle.	Check for obstructions blocking air flow and ensure that there are 12 inches of clearance between any obstacles and the vents on all sides of the machine.
FAULT CODE F02 DISPLAYED	Torch triggered before machine is ready	Torch triggered or turned on before machine is powered on will fault. Release torch trigger and machine will reset within five seconds.
FAULT CODE F09 DISPLAYED	Output short or abnormal voltage feedback.	Make sure the MIG wire is not touching the grounded work piece. Make sure the TIG electrode is not touching the grounded work piece.
	Stick electrode stuck to work piece	Make sure that your stick electrode is not stuck to the grounded work piece.

PROBLEM	POSSIBLE CAUSE	POSSIBLE SOLUTION
Low output or non-penetrating weld.	Weld parameters too low.	Adjust welding parameters
	Too long or improper extension cord.	Use a proper extension cord (#12 AWG wire or heavier, no longer than 25 ft.). See "Extension Cords", page 11.
	Poor ground connection or torch/electrode connection.	Reposition clamp and check cable to clamp connection. Check connection of ground cable, torch or electrode holder
	Input power too low.	Have a qualified electrician verify the voltage at your outlet. If the voltage is appropriate, verify that the circuit wiring is sufficient for the circuit breaker size.
Ground clamp, ground cable, and/or welding cable get hot.	Bad ground or loose ground connection.	Check connection of ground cable, torch or electrode holder. Check connection of the ground cable to the ground clamp. Tighten cable connection to ground clamp if needed. Ensure the connection between the ground clamp and workpiece is good and on clean, bare (not painted or rusted) metal. Make sure cable is not damaged.
Frequent circuit breaker trips.	Machine is drawing too much amperage due to use of larger size electrode.	Use a smaller electrode.
	Machine is not the only piece of electrical equipment on the circuit.	Make sure the welder is on a dedicated circuit or is the only thing plugged into a circuit.
	Circuit breaker is incorrect/insufficient for use with this machine.	Verify that the circuit breaker for the circuit is a 20A time-delay (slow-blow) breaker for 120V and a 50A for 230V. If it is not, have a qualified electrician install the proper breakers.
Poor quality welds.	Insufficient gas at weld area.	Check that the gas is not being blown away by drafts and, if so, move to a more sheltered weld area. If not, check gas cylinder contents, gauge, regulator setting, and operation of gas valve.
	Rusty, painted, oily or greasy workpiece.	Ensure workpiece is clean and dry.
	Poor ground connection or torch/electrode connection.	Check ground clamp/workpiece connection and all connections to the machine.
Difficult arc start.	Amperage is too low.	Increase amperage setting.
	Make sure base metal is clean.	Properly clean base metal.
	Make sure electrode is not damaged.	Replace electrode if needed.
Arc is wandering (TIG).	Tungsten is too large.	Use a smaller tungsten.
	Gas flow is too high.	Reduce gas flow.

Machine Parts Diagram & Replacement Parts List

NO.	PART NUMBER	ITEM DESCRIPTION
1	85668	Ground (50 Dinse)
2	85670	Electrode Holder (50 Dinse)
3	85516	120-230V Power Adaptor Plug
4	5084	Expert-Tech Tool

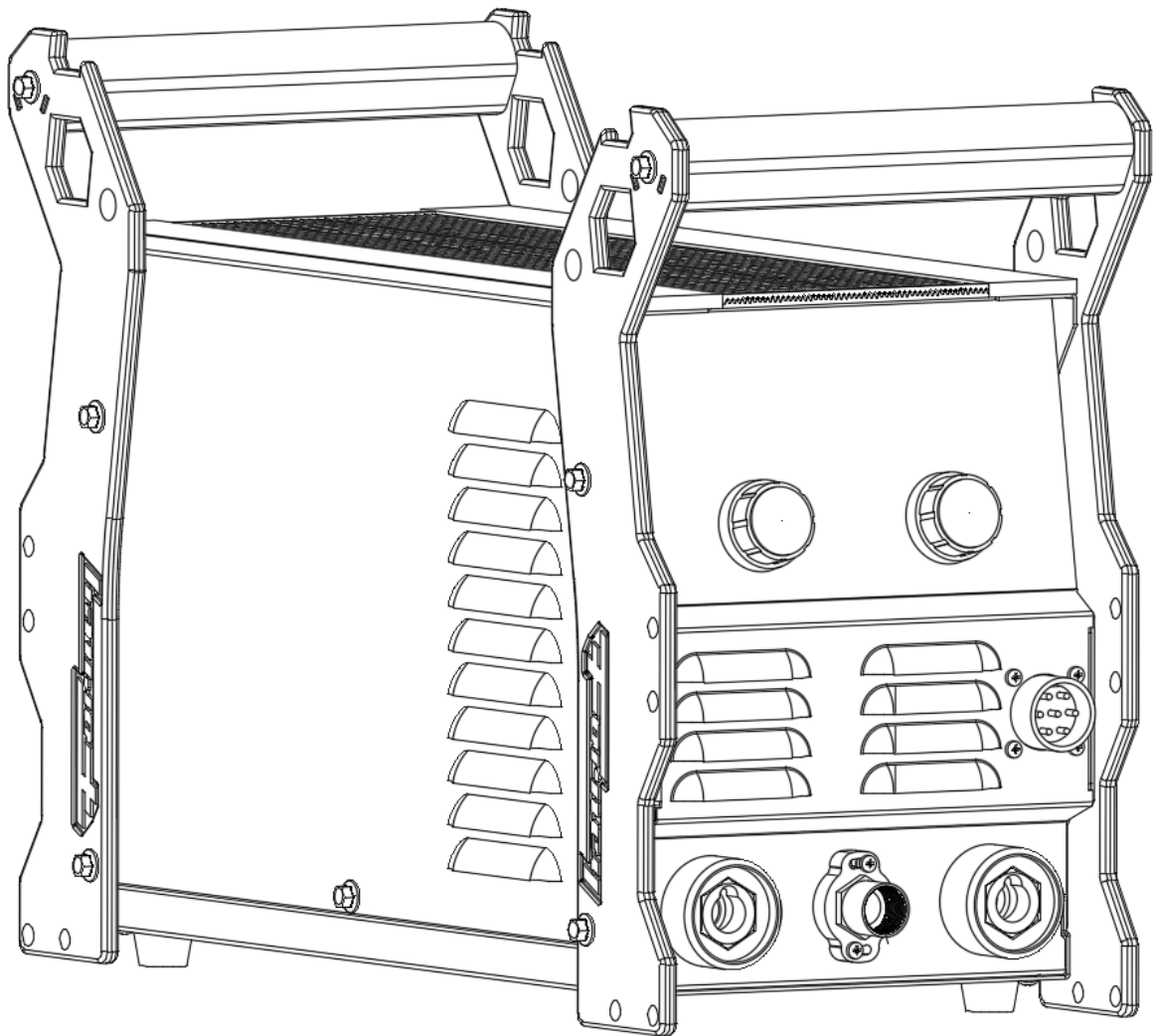



Forney Industries, Inc.
2057 Vermont Drive
Fort Collins, CO 80525
+1-800-521-6038
www.forneyind.com