



INSTRUCTIONS SL-467

Read carefully & save instructions for future reference.

PARTS

- (1) Ornate Column
- (1) Pedestal
- (1) Reservoir (bowl)

In Solar Panel Box:

- (1) Pump with 5m Cable
- (1) LED Light with 5m Cable
- (1) Solar Panel, Bracket, Tube, Spike

Ensure all parts are accounted for before disposing of packaging.

FOUNTAIN ASSEMBLY

Select a level location to place the fountain. Assemble components on a smooth, clean surface to avoid scratching or damaging the finish.

NOTE: The water tubing is built into the topper. Take care when handling the water tube; detaching the water tube from the topper will damage the fountain and void the product warranty.

1. Place reservoir on top of the pedestal and twist the reservoir clockwise to secure.

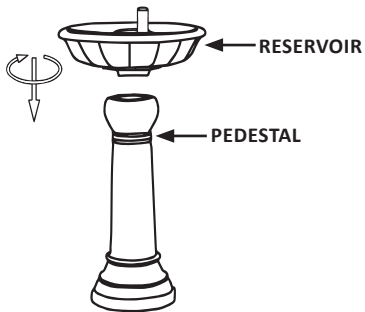

2. Feed the pump and LED light cables through the plastic tube in the reservoir, and through the channel on bottom of the pedestal.

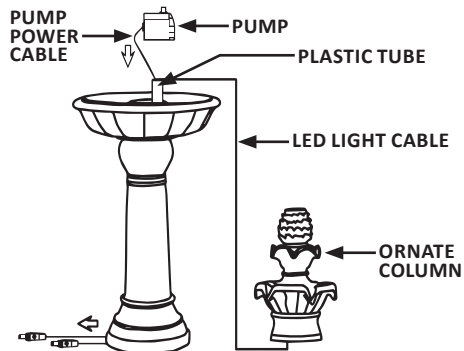

3. Attach the pump to the hose, then place ornate column onto the reservoir and twist the ornate column to secure.

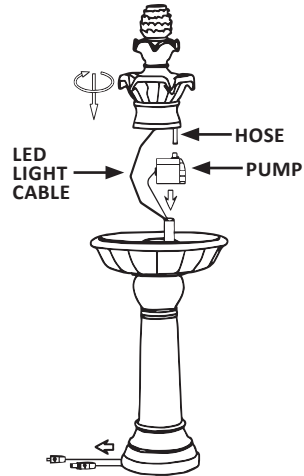

4. Fill the fountain with water, ensuring the pump is completely submerged during operation; approximately 1.5 gallons.

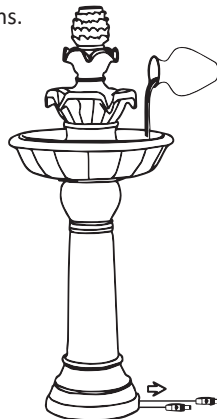

SOLAR PANEL ASSEMBLY

5. Connect the bracket, tube, and spike and attach the solar panel to the bracket as shown.

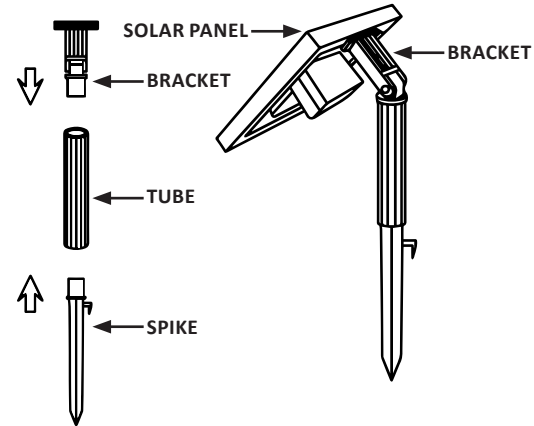

6. Insert the spike into the ground. Position the solar panel to face south (in the northern hemisphere) to make the most of daylight hours. It is important to angle the solar panel towards the sun when the sun is at its highest point. Ensure trees, shrubs, or buildings do not shade the solar panel.

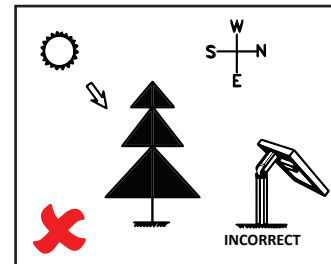
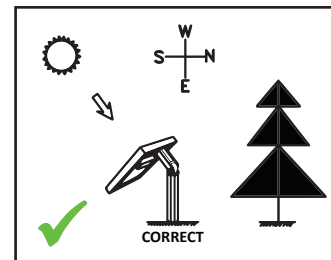

7. Connect the pump and LED light cables to the solar panel (charger sold separately).

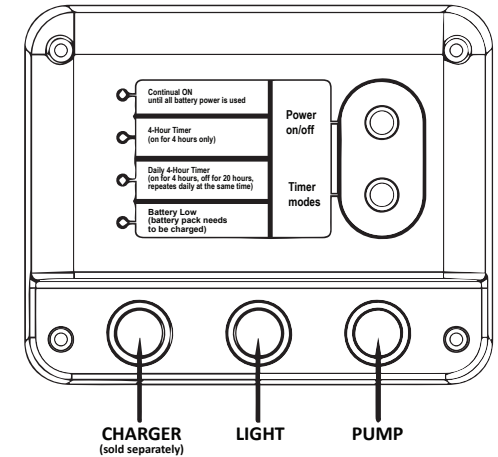

8. Your new fountain is ready to use. Refer to the Solar Panel Operation information on Page 3.

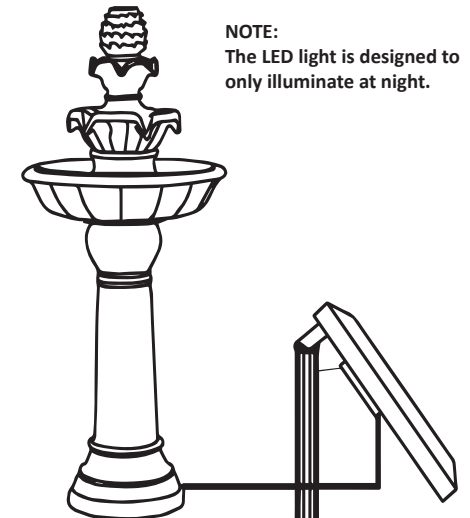

Over time, the finish may gradually mellow in color; this is part of the natural aging process.

9. SOLAR PANEL OPERATION

NOTE: The LED light is designed to only work at nighttime.

Continual ON Mode: Press [Power on/off] button, the top indicator light [continual on] will be lit — the pump will run continuously until the battery power runs out. The pump will automatically restart when the solar panel battery has been sufficiently charged with sunlight.

4-Hour Timer Mode: Press [Timer modes] button until the second indicator light [4hrs Timer] is lit — the pump will run for 4 hours and stop. The pump will not run again until the solar panel is manually restarted.

Daily 4-Hour Timer Mode: Press [Timer modes] button until the third indicator light [daily 4hrs Timer] is lit — the pump will run for 4 hours and shut down (in standby) for 20 hours; this operation will repeat daily at the same time. You can reset the pump's daily start-up time by switching it on at a new desired time in this same mode. **NOTE:** The third indicator light will blink slowly when the pump has reached the 4-hour runtime and be in standby for the following 20 hours. To save battery power, the indicator light will automatically turn off. You can activate the indicator light to check its status with a single push of either button; the indicator light will be on for a while and shut off again.

BATTERY LOW [RED INDICATOR LIGHT BLINKING]:

Battery power is low, and the pump will stop running soon to protect the battery. The red indicator light will turn off after the solar panel receives enough sunlight for the battery to be recharged.

PLEASE NOTE: This model allows for the battery pack to be charged with an original electric charger (sold separately). Only use the original battery charger as alternatives may damage the battery and will void the warranty. See contact information under WARRANTY to order the compatible charger.

10. PERFORMANCE OF PUMP

The performance of the pump depends on the orientation of the solar panel being toward the sun and sunlight strength; pump performance is not guaranteed when the solar panel is in the shade or poor weather conditions. Max. Data is obtained during optimal conditions (refer to Technical Data); solar panel performance cannot be guaranteed if placed in the shade or during poor weather conditions. The performance of the pump also depends on the battery power level; the pump cannot operate if battery power is low.

11. MAINTENANCE OF PUMP

This solar pump is designed to last for years if it is properly cleaned and maintained. If the pump starts losing power or stops working, clean the pump filter and impeller with clean water.

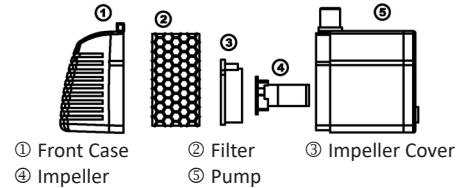

12. BATTERY INFORMATION

The Li-ion backup battery pack, like all rechargeable batteries, has a limited life span and becomes less efficient with repeated charge/discharge cycles. As the capacity of the battery reduces over time, you may not achieve the full hours of operation.

If you find that the battery appears less efficient, try to "boost charge" it by turning the power off for 1 to 2 sunny days to allow the battery to achieve a maximum charge. Occasional "boost charges" will help prolong the battery life. If your battery pack still does not perform to expectations after a boost charge, replace it with a new pack.

13. BATTERY REPLACEMENT

IMPORTANT: Only use original backup battery packs; alternatives may be incompatible, which may damage the system and will void the warranty.

See contact information under WARRANTY (page 4) to order the compatible replacement battery pack.

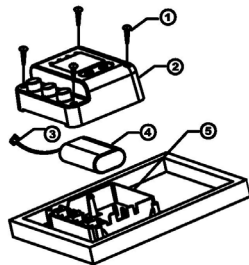

▪ Remove the screws (part 1) from the control panel cover (part 2) using a Phillips-head screwdriver.

▪ Disconnect the battery pack connector (part 3), and remove the battery pack (part 4) from control panel base (part 5).

▪ Connect the new battery pack connector to the control panel base and insert the battery.

▪ Replace the panel cover and tighten the screws.

Dispose of the batteries in accordance with local laws and regulations.

14. TROUBLESHOOTING

Check all solar panel, pump, and LED light connections. Make sure connections are secure and the cables are plugged into the correct ports on the control panel.

Ensure the solar panel is correctly positioned in a full-sun location and is not shaded by trees, shrubs or buildings; refer to page 2.

Check the control panel and confirm it is set to the preferred operation setting; refer to page 3.

If the [Battery Low] light is blinking, the battery pack power is critically low and requires charging. Switch off the pump and leave the solar panel in direct sunlight for at least 6 hours to recharge the battery pack.

Check the water level to make sure the pump is fully submerged.

Check the fountain tubing for kinks and obstructions. Also, check to make sure the tubing is tightly connected to the pump.

Check the pump to make sure it is not blocked by or clogged with debris.

The pump may be "air locked" from water levels getting too low or additional water being added. Turn the pump on/off several times to clear any air that may be trapped inside the pump.

15. TECHNICAL DATA

MAX. PUMP WATER FLOW: 250LPH

MAX. PUMP WATER LIFT: 90 cm

PUMP WORKING VOLTAGE: DC8.4V~DC6.5V

PUMP WORKING POWER: 1.2W~0.6W

PROTECTION GRADE OF PUMP: IP68

SOLAR PANEL: 2.5W-9V-0.277A

SOLAR PANEL SIZE: 190 x 150 x 18 mm

PROTECTION GRADE OF PANEL: IP44

LI-ION BATTERY PACK: 7.4V/1.5Ah

PROTECTION GRADE OF BATTERY BOX: IP44

LED LIGHT WORKING VOLTAGE: DC7.4V

LED LIGHT WORKING POWER: 0.15W

PROTECTION GRADE OF LED LIGHT: IP68

16. CARE INFORMATION

▪ Check the water level frequently to ensure the pump remains submerged; never allow the pump to run dry as it will burn out the motor.

▪ Clean the fountain, pump, and solar panel regularly. Do not use abrasive materials or harsh chemicals, such as bleach or chlorine, to clean the fountain.

▪ Always shut off the power supply before cleaning and maintaining the fountain and the pump.

▪ During freezing weather, drain the fountain, disconnect the pump, cables and solar panel, and store indoors; allowing ice to form inside the fountain will damage the fountain and void the warranty.

▪ The optimal temperature for lithium batteries is 10°C to 45°C, do not use the product beyond this temperature range.

IMPORTANT!

Fully charge the battery before storing. Over time, battery power discharges, so if it is stored at no charge, there is a chance it won't accept a charge again. To avoid this problem, disconnect the pump and leave the solar panel in direct sunlight for 1 or 2 days to ensure the battery has been recharged.

17. WARRANTY

Thank you for choosing Sunnydaze Decor. We stand behind our brand and the quality of the items we sell. Replacement parts or products will be sent at our discretion within the 1-year warranty period. Proof of purchase, with the date of purchase as well as photos of the merchandise defect, must be provided. Photos are used to determine the cause of defects and for future quality control. Register your warranty at <https://tiny.cc/SunnydazeWarranty>

If you have any questions, comments or concerns, feel free to contact us by phone at **833-982-1977**, email: customerservice@sunnydazedecor.com, or via our Contact Us page at

<https://tiny.cc/SunnydazeContact>

Purchase Date: ____/____/____

Order/Customer Ref. Number: _____

