

**MODEL: SL-0306  
GREEN DOVE WATER FEATURE  
ASSEMBLY INSTRUCTIONS  
READ AND SAVE THESE INSTRUCTIONS**

**UNPACK THE PACKAGE**  
YOU SHOULD HAVE RECEIVED LISTED PARTS:

- 1PC DOVE,
- 1PC BOWL,
- 1PC WATER PIPE
- 1PC RUBBER BUNG,
- 1PC PUMP,
- 1PC SOLAR PANEL,
- 1PC SOLAR PANEL BRACKET,
- 1PC SOLAR PANEL POST
- 1PC GROUND SPIKE.

TO PROTECT THE PRODUCT, PLACE ALL ON A SOFT SURFACE BEFORE ASSEMBLY.

**1. ATTACH WATER PIPE TO DOVE BASE WITH A PROVIDED RUBBER BUNG.**

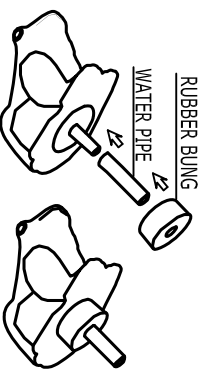

**2. ATTACH THE DOVE ONTO THE RESERVOIR, PIPE GET THROUGH THE HOLE ON TOP SURFACE OF RESERVOIR.**

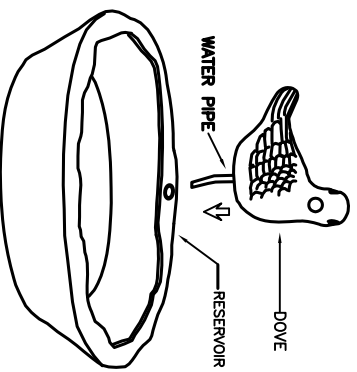

**3. ATTACH PUMP TO WATER PIPE, THE PUMP CABLE GET THROUGH OUT FROM A HOLE ON BACK SIDE OF THE RESERVOIR.**

A rubber bung is provided to cover the cable hole, so that you can fill the bowl with water as much as possible.

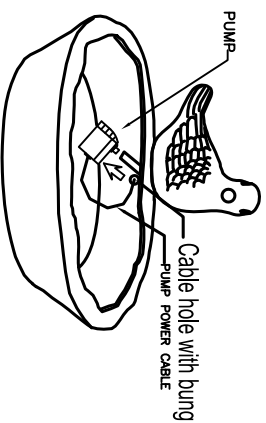

**4. ADD APPROPRIATE AMOUNT OF WATER INTO RESERVOIR, MAKE SURE THE PUMP IS FULLY IMMERSED IN WATER.**

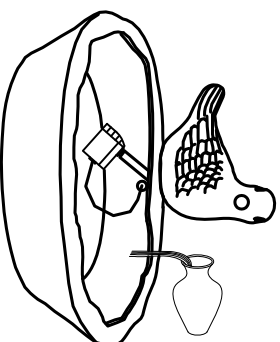

**5. JOIN BRACKET, POST AND SPIKE TOGETHER, THEN ATTACH BRACKET TO BACK OF THE SOLAR PANEL AS SHOWN.**

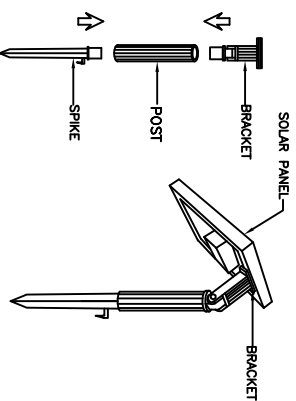

**6. TWIST PUMP PLUG SLIGHTLY AND PUSHING IT INTO THE HOLE FOR PUMP PLUG, MAKE SURE THE SEALING RINGS ARE FULLY IN GROOVES.**

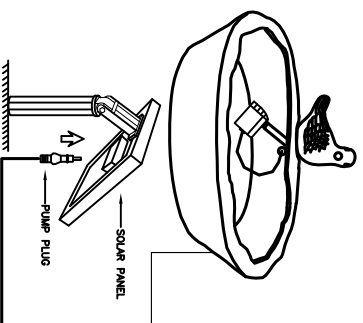

**7. INSERT THE SPIKE INTO THE GROUND. POSITION THE SOLAR PANEL TO FACE SOUTH (In Northern Hemisphere) AS MUCH AS POSSIBLE TO MAKE THE MOST OF THE DAYLIGHT HOURS. IT IS IMPORTANT TO ANGLE THE SOLAR PANEL TO FACE SUN WHEN SUN IS AT ITS HIGHEST POINT. ENSURE THE SOLAR PANEL IS NOT SHADED BY TREES, SHRUBS OR BUILDINGS.**

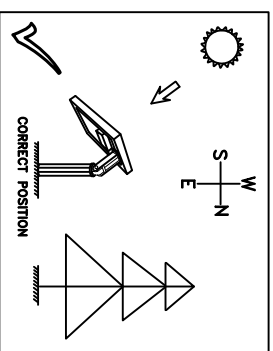

**SOLAR PUMP FUNCTIONS:**

THIS SOLAR PUMP IS DESIGNED PRIMARILY TO OPERATE IN SUMMER MONTHS BUT ALSO WORK IN SPRING AND AUTUMN PROVIDED THERE IS GOOD SUNSHINE.

THIS PUMP RUNS FROM DIRECT SUNLIGHT. PUMP PERFORMANCE DEPENDS THE AMOUNT AND STRENGTH OF SUNLIGHT RECEIVED BY SOLAR PANEL.

**TROUBLE SHOOTING:**

1. IF YOUR FOUNTAIN DOES NOT WORK, CHECK SOLAR PANEL IS IN CORRECT POSITION, RECEIVING DIRECT SUNLIGHT AND NOT IN SHADOW.
2. CHECK CONNECTIONS BETWEEN THE PUMP AND THE SOLAR PANEL.
3. CHECK WATER LEVEL AND MAKE SURE THE PUMP IS FULLY SUBMERGED.
4. CHECK PUMP IMPELLER BLOCKED BY DEBRIS.
5. THE PUMP MAY BE "AIR LOCKED". PLUG AND UNPLUG THE PUMP SEVERAL TIMES TO CLEAR ANY AIR THAT MAY HAVE BEEN TRAPPED.

**MAINTENANCE OF PUMP**

IF YOU FIND THE PUMP START LOSING POWER OR STOP WORKING, CHECK THE PUMP FILTER AND IMPELLER BLOCKED, CLEAR WITH WATER.



- ① FRONT CASE
- ② FILTER
- ③ IMPELLER COVER
- ④ IMPELLER
- ⑤ PUMP

**WINTER PROJECT INDOOR STORAGE IS RECOMMENDED IN WINTER.**

**WARRANTY**

THANK YOU FOR CHOOSING SUNNYDAZE DECOR. IF YOU HAVE ANY QUESTIONS, COMMENTS OR CONCERNS PLEASE FEEL FREE TO CONTACT US BY PHONE AT: 888-881-4668. BY EMAIL: CUSTOMERSERVICE@SERENITYHEALTH.COM, OR YOU COULD ALSO EMAIL US VIA OUR CONTACT US PAGE AT: WWW.SERENITYHEALTH.COM/CONTACT-US.

WE STAND BEHIND OUR BRAND AND THE QUALITY OF THE ITEMS WE SELL. WE WILL SEND NEW PARTS, OR REPLACE PRODUCTS AT OUR DISCRETION WITHIN **THE ONE-YEAR WARRANTY PERIOD**, BEFORE WE CAN HELP. YOU WILL NEED TO PROVIDE PROOF OF PURCHASE WITH THE DATE OF PURCHASE AND PHOTOS OF THE DEFECTIVE MERCHANDISE. WE WILL USE THE PHOTOS TO DETERMINE THE CAUSE OF DEFECT AND FOR FUTURE QUALITY CONTROL.

