











Thank you for choosing Sunnydaze Decor. We stand behind our brand and the quality of the items we sell. Replacement parts or products will be sent at our discretion within the 1-year warranty period. Proof of purchase, with the date of purchase as well as photos of the merchandise defect, must be provided. Photos are used to determine the cause of defects and for future quality control. Register your warranty at <https://tiny.cc/SunnydazeWarranty>
 If you have any questions, comments or concerns, feel free to contact us by phone at 833-982-1977, by email: customerservice@sunnydazedecor.com, or via our contact us page at <https://tiny.cc/SunnydazeContact>

ICE BUCKET WITH STAND AND TRAY RCM-511

Review all assembly and care information carefully before using this product. Save this manual for future reference.
Assemble components on a soft, clean surface to avoid damaging the finish.



Inspect packaging to ensure all parts are accounted for before disposing of packing materials.
 Save the packing slip.

No.	PARTS		QTY.
A		Bucket	1
B		Tray	1
C		Top Ring	1
D		Bottom Ring	1
E		Top Tube	3
F		Bottom Tube	3
G		Middle Tube	3
H		M6x35mm Bolt	9
I		Nut	9
J		Hex Key	1

⚠ WARNING ⚠

CHOKING HAZARD — This item contains small parts that can be swallowed. Keep children and pets away during assembly.



**SCAN THIS
CODE WITH A
SMARTPHONE
TO VIEW OUR
ASSEMBLY VIDEO**

⚠ WARNING:

Manufacturer and seller expressly disclaim any and all liability from personal injury, property damage or loss, whether direct or indirect, or incidental, resulting from the incorrect attachment, improper use, inadequate maintenance, or neglect of this product.

ASSEMBLY

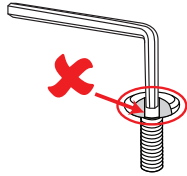
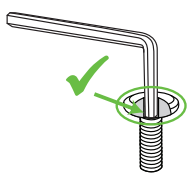

Tip: Always fully insert the hex key inside designated notch of the bolt.

If the hex key is not fully inside the notch, the hex key could slip out, causing damage to the bolt head. Repeated hex key slipping will cause the notch to become rounded, making it difficult or impossible to tighten the bolt with the hex key.

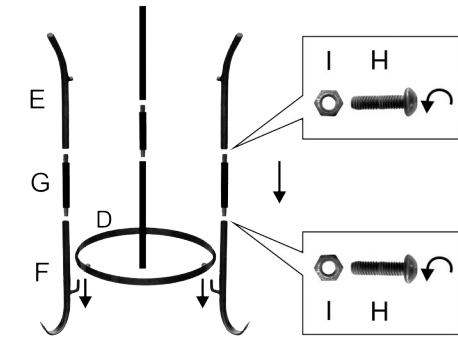

STEP 1

D: 1 E: 3 F: 3
G: 3 H: 6 I: 6

Assemble the legs by securing three Top Tubes (E), three Middle Tubes (G), and three Bottom Tubes (F) using six Bolts (H) and Nuts (I).

Align Bottom Ring (D) with the hooks on assembled legs.

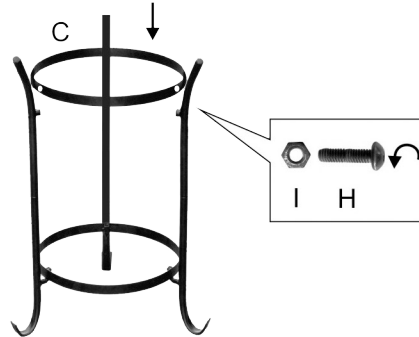

STEP 2

C: 1 H: 3 I: 3

Insert Bolt (H) through the top of the leg and Top Ring (C), secure using Nut (I).

NOTE: *Minor force is needed to secure the last leg to the ring. This is an intentional design for additional stability.*

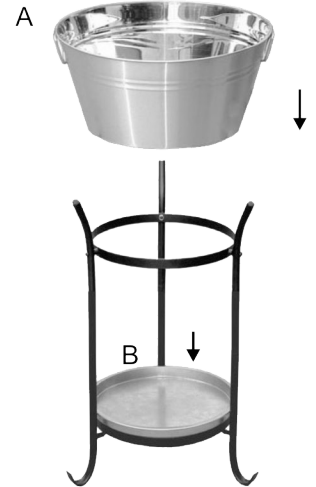

STEP 3

A: 1 B: 1

Place Tray (B) onto the bottom ring, and Bucket (A) on the top ring.

General Use & Care

Do not use harsh chemicals or abrasive materials to clean this unit.

SAFE USE: Do not overload the bucket or tray as doing so may cause the stand to buckle. If the stand appears to be unstable, remove some of the weight in the bucket and tray. Do not transport the bucket or tray with heavy loads.

CLEANING: Use a damp cloth to wipe soiled surfaces. Dry with a soft, lint-free cloth to prevent water spotting and/or rust.

STORAGE: Store in a cool, dry place when not in use. Do not leave unit outdoors.

Any modification to the product or failure to follow recommended care will void the product warranty.

TIPS FOR KEEPING BEVERAGES COLD

The galvanized beverage container is not insulated; the bucket will accumulate condensation and drip water.

Here are some tips for keeping beverages colder, longer.

- Select a shady spot.
- Refill ice often. By refilling often, you will keep the entire container and existing ice colder.
- Ensure beverages are completely chilled before they are put into the ice.
- Freeze personal-sized water bottles and place them in the bucket to slow ice melting. Plus, your guests can pick them out for drinking.
- Consider reusable ice packs such as those used to ship food items.
- Use ice blocks and large ice cubes. Large pieces of ice take longer to melt than small cubes.
- Wrap the ice bucket with a blanket and secure it with clothespins. This helps maintain temperature and prevents condensation from dripping onto the floor.