

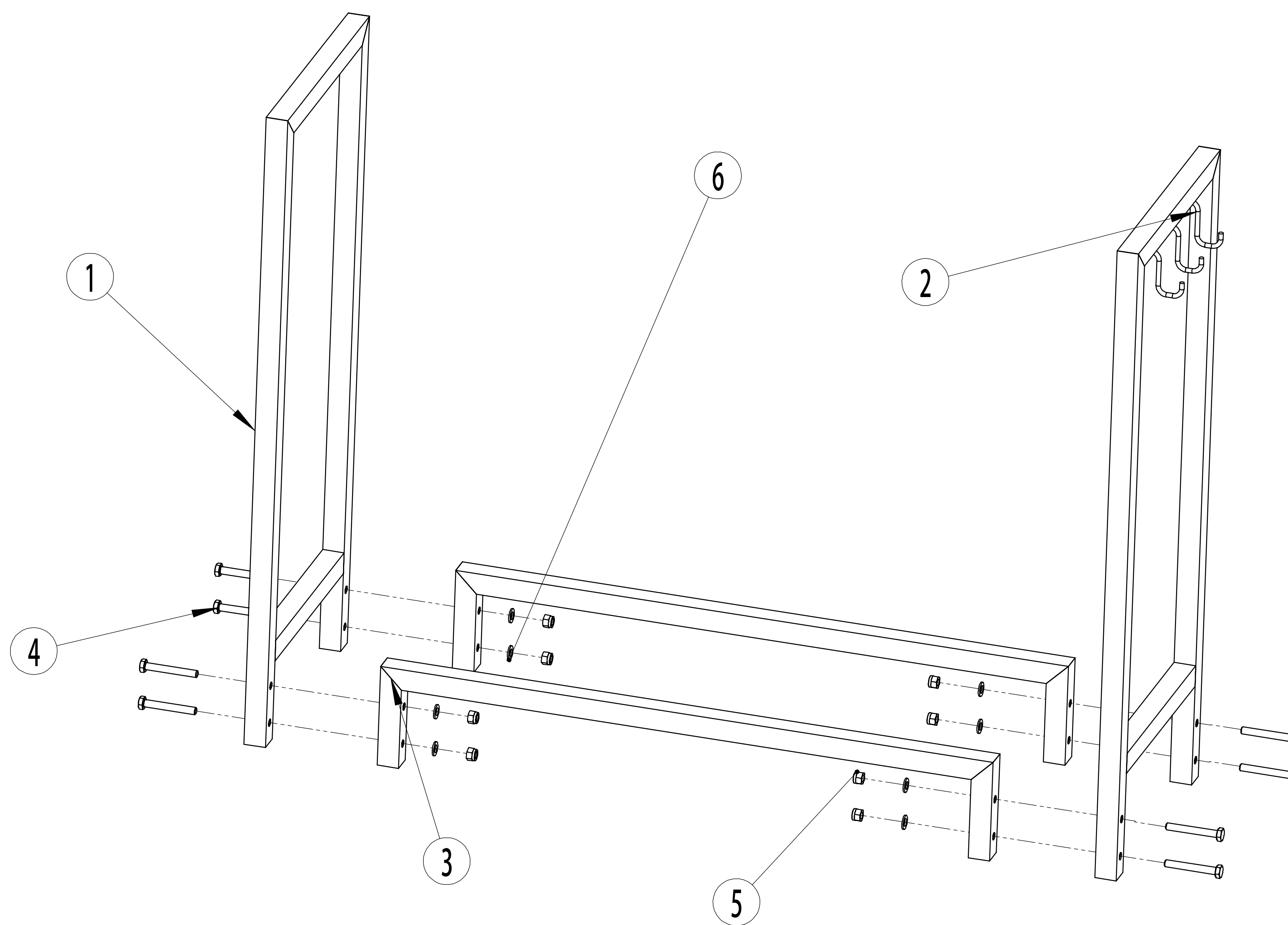





Thank you for choosing Sunnydaze Decor. If you have any questions, comments or concerns please feel free to contact us by phone at: **888-881-4668**, by email: **customerservice@serenityhealth.com**, or you could also email us via our contact us page at: **www.SerenityHealth.com/contact\_us.php**.

We stand behind our brand and the quality of the items we sell. We will send new parts, or replace products at our discretion within the one year warranty period. Before we can help, you will need to provide proof of purchase with the date of purchase and photos of the defective merchandise. We will use the photos to determine the cause of defect and for future quality control.

## 30" Black Steel Firewood Log Rack #QXWR30 Instruction

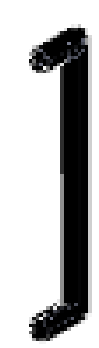

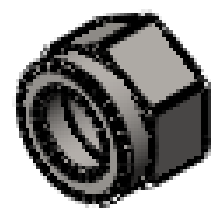
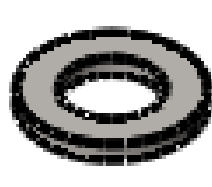
| Item | Parts Drawing                                                                        | Qty |
|------|--------------------------------------------------------------------------------------|-----|
| 1    |  | 1   |
| 2    |  | 1   |
| 3    |  | 2   |
| 4    |  | 8   |
| 5    |  | 8   |
| 6    |  | 8   |