

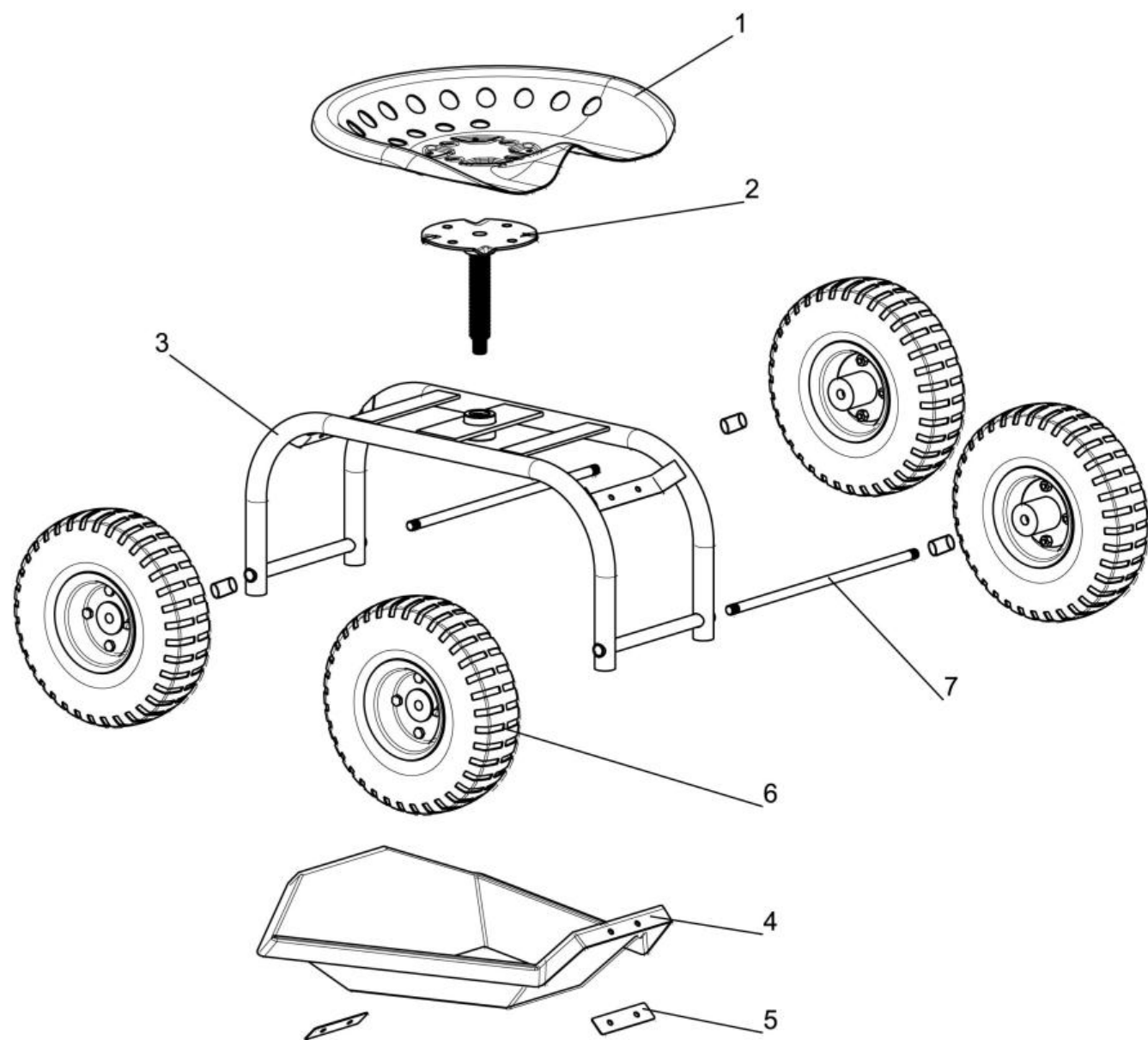

Thank you for choosing Sunnydaze Décor. If you have any questions, comments or concerns please feel free to contact us by phone at: **888-881-4668**, by email: [customerservice@serenityhealth.com](mailto:customerservice@serenityhealth.com), or you could also email us via our contact us page at: [www.SerenityHealth.com/contact-us/](http://www.SerenityHealth.com/contact-us/).

We stand behind our brand and the quality of the items we sell. We will send new parts, or replace products at our discretion within the one year warranty period. Before we can help, you will need to provide proof of purchase with the date of purchase and photos of the defective merchandise. We will use the photos to determine the cause of defect and for future quality control.

Figure 1



## Rolling Cart with Seat

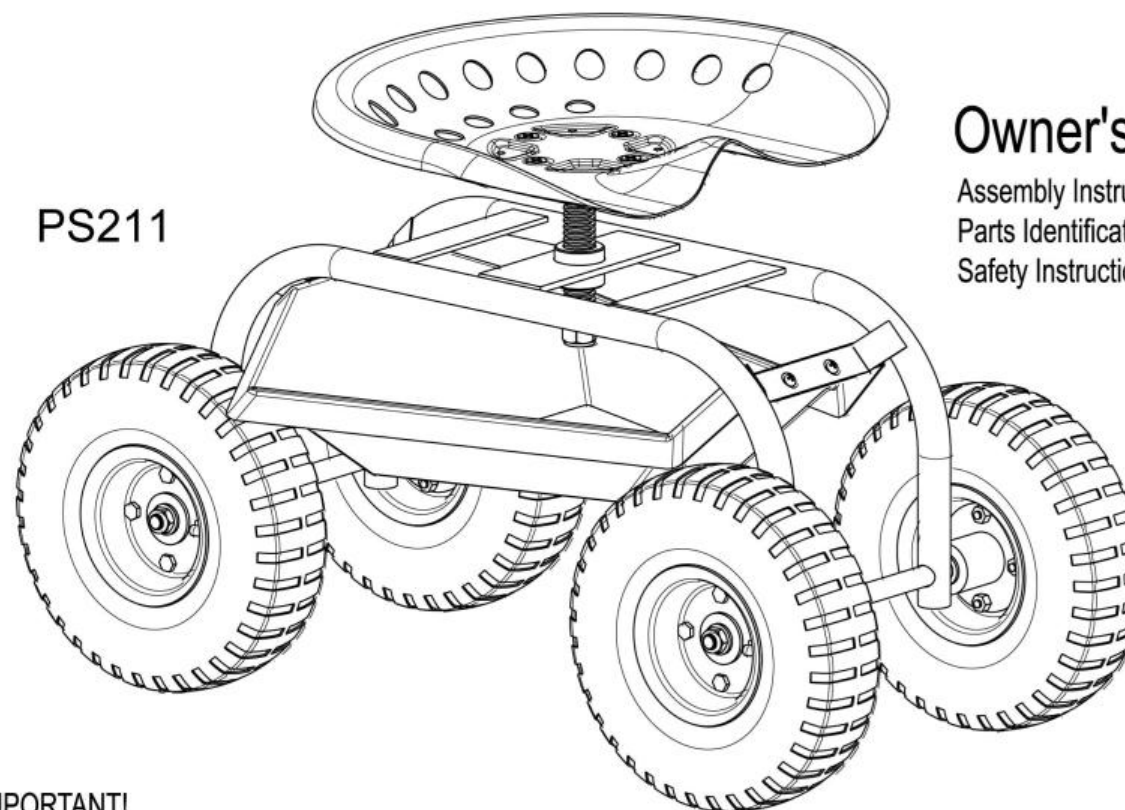

### Owner's Manual

Assembly Instructions  
Parts Identification  
Safety Instructions

**IMPORTANT!**  
Please read and follow ALL instructions before assembling or using this product.

## Safety Instructions

**This is not a toy. Not for use by children.**

Maximum load capacity of rolling seat: 300 lb.

Maximum load capacity of plastic tray: 5 lb.

Do NOT overinflate the tires. Maximum pressure is 30 psi.

Do NOT use on inclines; seat may tip.







Do NOT operate if any part is damaged or broken.

Made in China

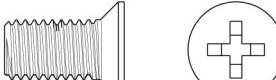

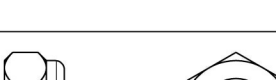
# Assembly Instructions

This product requires assembly. Carefully remove all the parts from the box and identify and organize them before proceeding with the assembly. Refer to the Parts List diagram below. You will require two Phillips screwdrivers (#2 and #3) and two adjustable wrenches.

## HARDWARE LIST

Item	Item Name	Diagram	Quantity
A	Bolt (M8x20)		4 Pcs
B	Bolt (M10 x 20)		4 Pcs
C	Nut (M8)		4 Pcs
D	Nut (M10)		4 Pcs
E	Nut (M12)		4 Pcs
F	Flat Washer (Ø8)		4 Pcs
G	Flat Washer (Ø10)		4 Pcs
H	Flat Washer (Ø12)		4 Pc

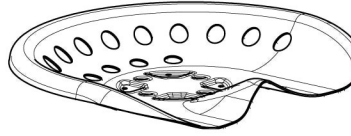
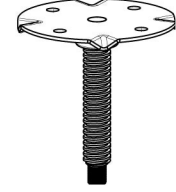
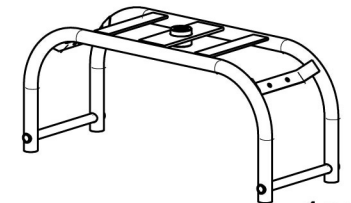
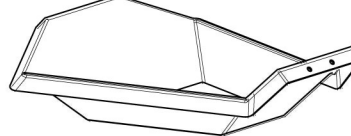
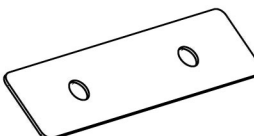
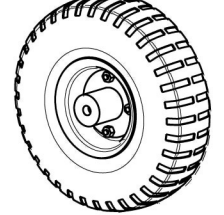
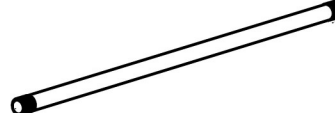
## Parts List

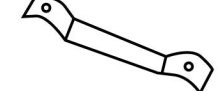
<b>1. Seat</b>  <b>1 pc</b>	<b>2. Seat Post</b>  <b>1 pc</b>	<b>3. Cart Frame</b>  <b>1 pc</b>
<b>4. Plastic Tool Tray</b>  <b>1 pc</b>	<b>5. Brackets</b>  <b>2 pcs</b>	<b>6. Wheel</b>  <b>4 pcs</b>
<b>7. Wheel Axles</b>  <b>2 pcs</b>	<b>8. Axle Bracket</b>  <b>4 pcs</b>	<b>9. Rear tray support</b>  <b>1 pc</b>

Read these instructions completely before beginning assembly.

### STEP 1

Place the frame as shown in Figure 1. Attach the plastic tray where shown in Figure 1, using the two small reinforcing plates, four 8X20 mm bolts, four 8mm washers, and four 8mm nuts.

### STEP 2

Insert the rear axle into the back of the frame. Slide one axle bracket onto each end of the rear axle. Mount one wheel (with the valve stem facing out), then slide another 12mm washer onto axle

### STEP 3

Insert the front axle into the front of the frame. Slide one axle bracket onto each end of the front axle. Mount one wheel (with the valve stem facing out), then slide another 12mm washer onto axle

### STEP 4

Attach the seat to the seat post (already mounted on the frame) using four M10x20mm bolts, four 10mm washers, and four 10mm nuts. Rotate the seat to adjust the height of the seat.