

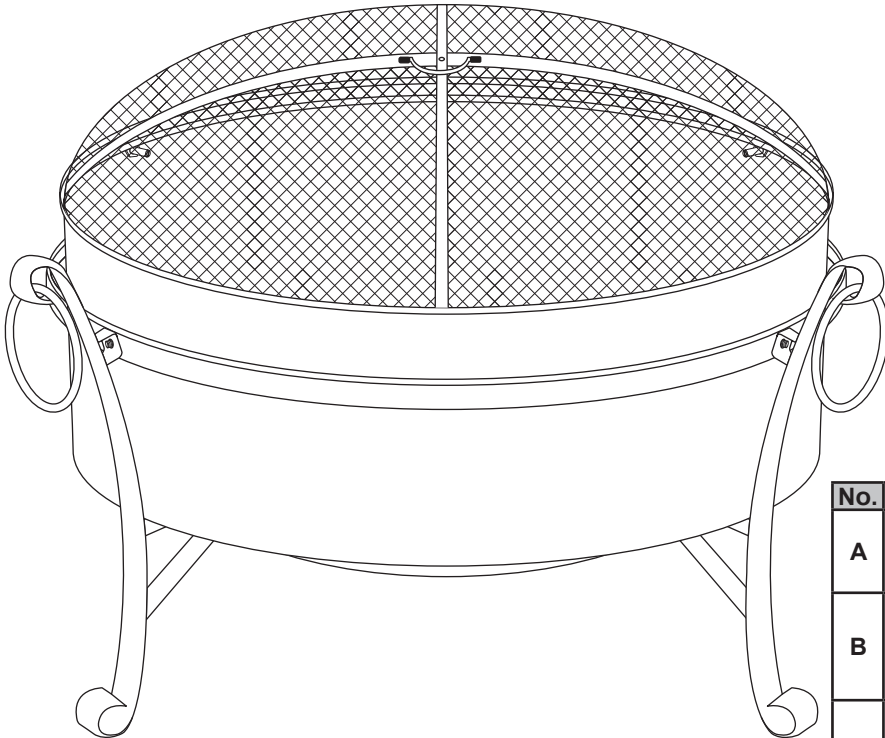

CAULDRON FIRE PIT







NB-CF24 • NB-CF34

Read the assembly instructions carefully and follow the care instructions. Save these instructions for future reference.
Assemble components on a soft, clean surface to avoid scratching or damaging the finish.



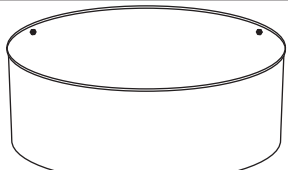
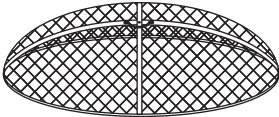

Inspect packaging to ensure all parts are accounted for before disposing of packing materials.
 Save the packing slip.

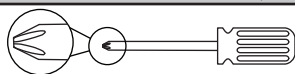

No.	PARTS	QTY.
A	 Leg	4
B	 Top Ring	1
C	 Bottom Ring	1
D	 Fire Bowl	1
E	 Spark Screen	1
F	 Poker/Lifting Tool	1
G	 M6 Bolt	8
H	 M8 Grub Screw	3

TOOLS REQUIRED (not included)



Phillips Screwdriver

⚠ WARNING ⚠

CHOKING HAZARD — This item contains small parts that can be swallowed. Keep children and pets away during assembly.

⚠ WARNING:
 Manufacturer and seller expressly disclaim any and all liability from personal injury, property damage or loss, whether direct or indirect, or incidental, resulting from the incorrect attachment, improper use, inadequate maintenance, or neglect of this product.

ASSEMBLY

STEP 1

A: 4
C: 1
G: 4

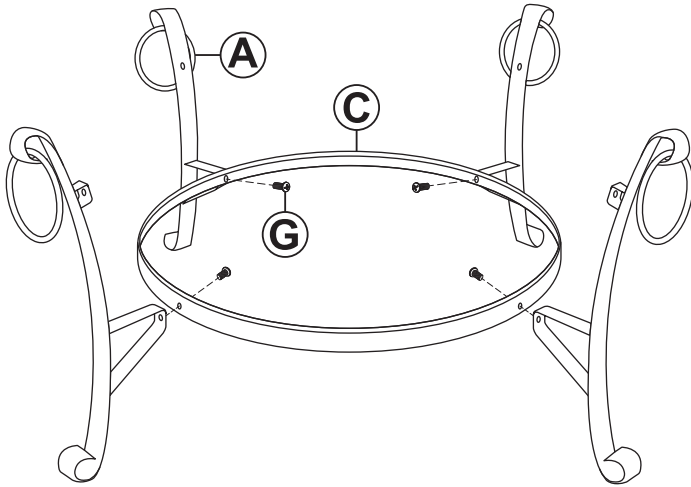

Loosely secure four Legs (A) to Bottom Ring (C) by hand-tightening four M6 Bolts (G).

Do not fully tighten bolts until after the top ring is installed.

STEP 2

B: 1
G: 4

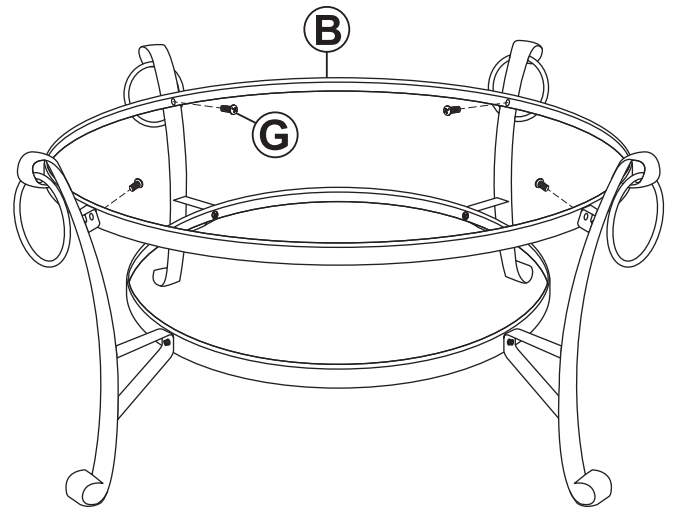

Align Top Ring (B) with the tops of the legs and loosely secure by hand-tightening four M6 Bolts (G).

Fully tighten all bolts on the top and bottom rings.

STEP 3

D: 1
H: 3

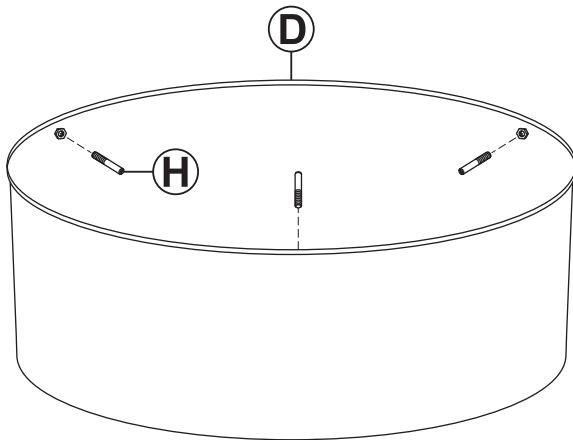

Install three M8 Grub Screws (H) to the inside rim of Fire Bowl (D).

STEP 4

E: 1

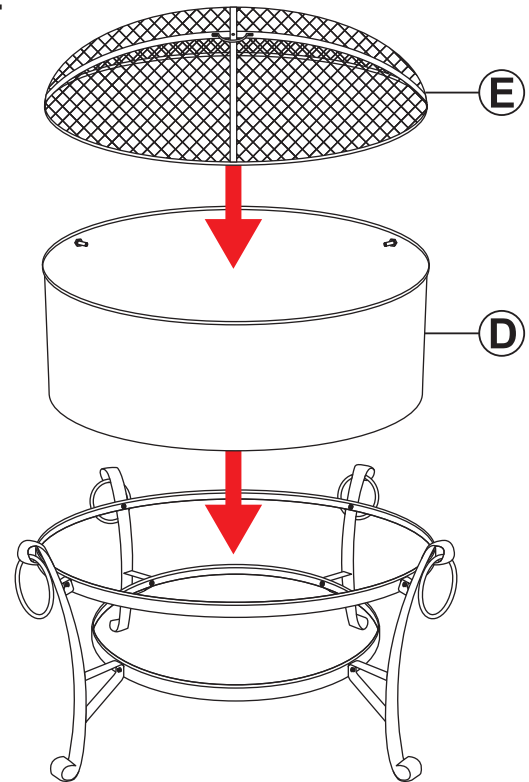

Place Fire Bowl (D) inside the assembled frame and place Spark Screen (E) onto the fire bowl.

CARE & MAINTENANCE

SAFE USE: Always use fire pits on a flat, non-combustible surface such as concrete, rock, or stone. Do not use this fire pit on a wood deck or any other combustible surfaces like dry grass, leaves, mulch, etc. Never use in an area with an overhead structure or near any unprotected combustible constructions like vinyl or wood siding. Avoid using near or under overhanging trees and shrubs.

The fire pit and screen will become extremely hot while in use. Always use the poker/lifting tool and heat-resistant gloves when maintaining a fire.

NO ACCELERANTS, NO PLASTICS: Never use an accelerant, i.e. gasoline or kerosene, to start a fire; this is dangerous and can damage your fire pit.

Never use any plastic materials in or nearby a fire pit. The emissions from burning plastic are toxic. Additionally, plastic residue is very difficult to remove and could plug the drainage hole.

EXTINGUISH: Let fires gradually die down and go out on its own. DO NOT use water to put out a fire as the sudden drop in temperature may damage the metal and/or cause serious injury.

EXPOSURE & MAINTENANCE: Long-term exposure to high-intensity heat can cause the mesh screen to warp and the high-temperature paint to flake or burn off the steel. If the paint burns off and the steel is exposed to moisture, it will rust. As with any outdoor steel product, periodic maintenance is required to maintain integrity and appearance. Remove rust and refinish with a paint that is suitable for high-temperature surfaces; carefully follow the paint manufacturer instructions and ensure the paint is completely dry before using the unit again. **WARNING:** The one-year warranty does not cover damages or defects caused by painting and/or repairs.

CLEANING: Ensure the fire pit and ashes are completely cool before cleaning. Ashes can remain hot long after a fire dies down. If you feel heat when your hand is close to the metal or the ashes, the fire pit is too hot to clean.

Remove ashes and debris from the fire bowl before every use.

COVER AND STORE: Ensure the fire pit is completely cool before covering (cover not included). Always clean the fire pit before covering it. Do not allow the fire pit to be exposed to water. The manufacturer is not liable for damage resulting from general use and/or environmental conditions. Store in a dry location; this will protect it from the effects of weather elements.

SAFETY STATEMENTS & WARNINGS

- For outdoor use only. Never use this product in an enclosed area.
- Always follow local laws and regulations when using wood-burning fire pits.
- Exercise the same care and precautions as you would with an open fire.
- Always supervise children and pets when they are in proximity of this product, whether it is in use or not in use.
- Never use any fire pit during dry or windy conditions.
- Keep unit a safe distance away from buildings, balconies, or overhangs when in use.
- Do not use on or near combustible surfaces or structures such as wood decks, dry leaves or grass, mulch, vinyl or wood siding, etc.
- Only use this fire pit on a level, non-combustible surface.
- Keep away from all combustible materials including gasoline and other flammable liquids and vapors.
- Never use accelerants such as, but not limited to, gasoline, alcohol, paint thinners, kerosene, as this may cause serious injury or product damage.
- Do not overfill or use this unit or use it to burn leaves or trash.
- The fire pit becomes very hot when in use. Use the lid lifter to handle the hot screen. Let the unit completely cool before cleaning or moving.
- Never leave unit unattended while hot or in use.
- Extinguish the fire properly before leaving it unattended. If necessary, use a fire extinguisher or sand to smother the fire. NEVER use water to extinguish hot fires or embers as doing so may cause serious injury and/or permanently damage the product.
- Ashes can remain hot for a long time after fire is extinguished. Dispose of cold ashes properly.
- Ensure the unit is completely cool before covering, failure to do so will damage the cover and the unit.
- DO NOT USE CHEMICAL-BASED CLEANERS as this may damage the product and/or ignite a flame during the next use.

Contact the local authorities regarding possible burn restrictions before using this product.

Any modification to the product or failure to follow recommended care will void the product warranty.

WARNING:

Manufacturer and seller expressly disclaim any and all liability from personal injury, property damage or loss, whether direct or indirect, or incidental, resulting from the incorrect attachment, improper use, inadequate maintenance, or neglect of this product.