







HEAVY-DUTY SQUARE FIRE RIM KF-SHDFPR

Read all assembly and care instructions carefully before using this product. Save this manual for future reference.
Assemble components on a soft, clean surface to avoid damaging the finish.

No.	PARTS		QTY.
A		Panel	4
T		1/4" x 5/8" Bolt	16
U		Washer	16
V		Nut	16
X		Hex Key	1
Y		Spanner	1
Z		Poker	1

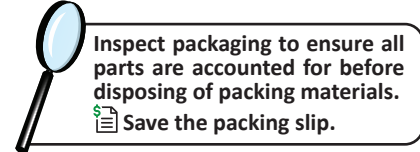

⚠ WARNING ⚠

CHOKING HAZARD — This item contains small parts that can be swallowed. Keep children and pets away during assembly.

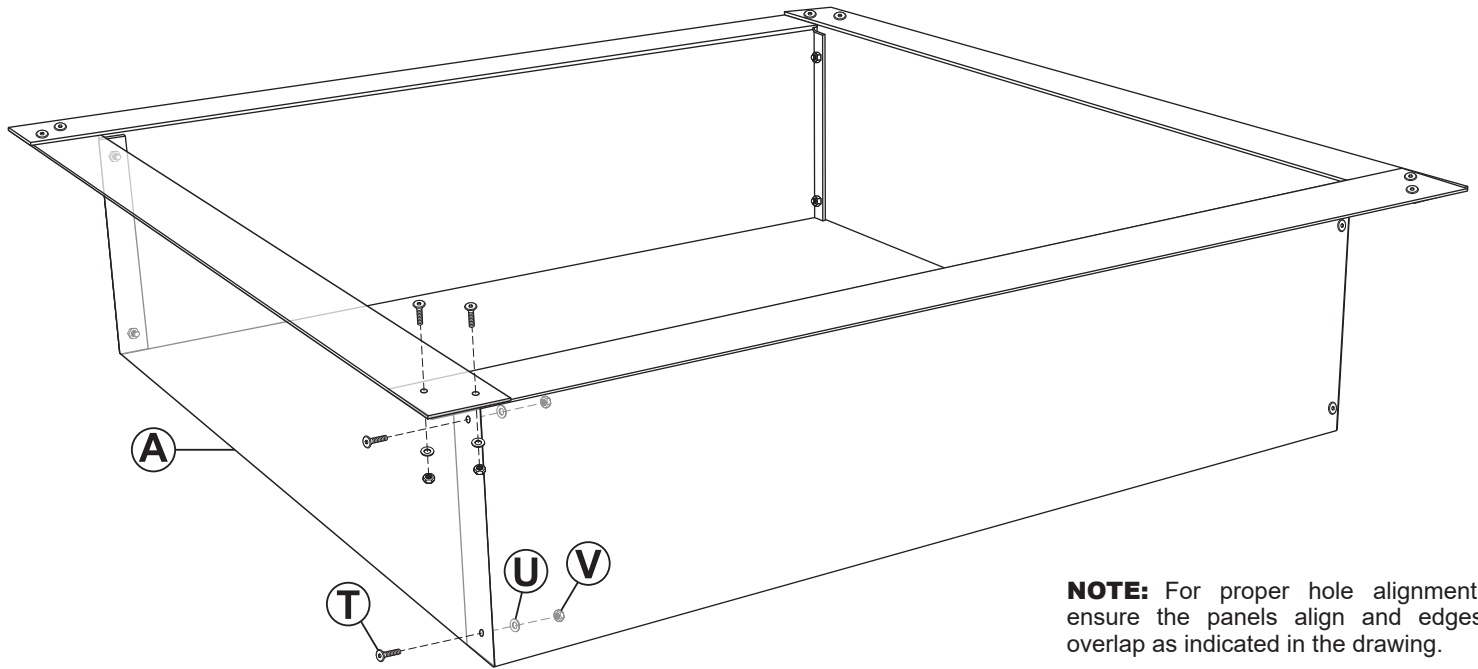

NOTE: For proper hole alignment, ensure the panels align and edges overlap as indicated in the drawing.

ASSEMBLY

◀ DO NOT FULLY TIGHTEN THE NUTS & BOLTS UNTIL AFTER ALL HARDWARE HAS BEEN LOOSELY FASTENED. ▶

1. Align the holes on the top and sides of Panels (A). **NOTE:** The bent edge of each panel must install on the inside of the adjacent panel.
2. Loosely secure two panels by hand-tightening four Bolts (T), four Washers (U), and four Nuts (V).
3. Repeat Step 2 until all panels are connected.
4. Fully tighten all hardware using included Hex Key (X) and Spanner (Y).

CARE & MAINTENANCE

SAFE USE: Always use fire rings on a flat, non-combustible surface such as concrete or dirt. Do not use this fire ring on a wood deck, asphalt, or any other combustible surfaces like dry grass, leaves, mulch, etc. Never use in an area with an overhead structure or near any unprotected combustible constructions like vinyl or wood siding. Avoid using near or under overhanging trees and shrubs. Surround the outside of the unit with a fire resistant structure like cement, brick, or stone.

The fire rim will become extremely hot while in use. Always use the poker and heat-resistant gloves when maintaining a fire.

NO ACCELERANTS, NO PLASTICS: Never use an accelerant, i.e. gasoline or kerosene, to start a fire; this is dangerous and can damage your fire pit.

Never use any plastic materials in or nearby a fire pit. The emissions from burning plastic are toxic. Additionally, plastic residue is very difficult to remove.

EXTINGUISH: Let fires gradually die down and go out on its own. DO NOT use water to put out a fire as the sudden drop in temperature may damage the metal and/or cause serious injury.

EXPOSURE & MAINTENANCE: Long-term exposure to high-intensity heat can cause the high-temperature paint to flake or burn off the steel. If the paint burns off and the steel is exposed to moisture, it will rust. As with any outdoor steel product, periodic maintenance is required to maintain integrity and appearance. Remove rust and refinish with a paint that is suitable for high-temperature surfaces; carefully follow the paint manufacturer instructions and ensure the paint is completely dry before using the unit again. **WARNING:** The one-year warranty does not cover damages or defects caused by painting and/or repairs.

CLEANING: Ensure the unit and ashes are completely cool before cleaning. Ashes can remain hot long after a fire dies down. If you feel heat when your hand is close to the metal or the ashes, the fire pit is too hot to clean.

Remove ashes and debris from the fire pit before every use.

SAFETY STATEMENTS & WARNINGS

- For outdoor use only. Never use this product in an enclosed area.
- Always follow local laws and regulations when using fire pits.
- Exercise the same care and precautions as you would with an open fire.
- Always supervise children and pets when they are in proximity of this product, whether it is in use or not in use.
- Never use any fire pit during dry or windy conditions.
- Keep unit a safe distance away from buildings, balconies, or overhangs when in use.
- Do not use on or near combustible surfaces or structures such as wood decks, dry leaves or grass, mulch, vinyl or wood siding, etc.
- Only use this fire pit on a level, non-combustible surface.
- Keep away from all combustible materials including gasoline and other flammable liquids and vapors.
- Never use accelerants such as, but not limited to, gasoline, alcohol, paint thinners, kerosene, as this may cause serious injury or product damage.
- Do not overfill or use this unit or use it to burn leaves or trash.
- The fire pit becomes very hot when in use. Let the unit completely cool before cleaning or moving.
- Never leave unit unattended while hot or in use.
- Extinguish the fire properly before leaving it unattended. If necessary, use a fire extinguisher or sand to smother the fire. NEVER use water to extinguish hot fires or embers as doing so may cause serious injury and/or permanently damage the product.
- Ashes can remain hot for a long time after fire is extinguished. Dispose of cold ashes properly.
- Ensure the unit is completely cool before covering, failure to do so will damage the cover and the unit.
- DO NOT USE CHEMICAL-BASED CLEANERS as this may damage the product and/or ignite a flame during the next use.

Contact the local authorities regarding possible burn restrictions before using this product.

Any modification to the product or failure to follow recommended care will void the product warranty.

If you experience issues with assembly or the product was damaged during shipping, please contact our customer service team through one of the methods mentioned at the top of page 1.

Please have the item number and order information ready to expedite response time.

WARNING:

Manufacturer and seller expressly disclaim any and all liability from personal injury, property damage or loss, whether direct or indirect, or incidental, resulting from the incorrect attachment, improper use, inadequate maintenance, or neglect of this product.