

LintEater[®]

Rotary Dryer Vent Cleaning System

Operator's Manual

Thank you for purchasing the **LintEater**[®] Rotary Dryer Vent Cleaning System. Please follow the important safeguards and operating instructions included within this manual to enjoy the convenience and durability of our product.

The **LintEater**[®] System includes:



4 - 36" Long flexible rods screw together to reach into vents up to 12' from one end.



1 - Self-feeding 4" Auger Brush makes multiple turns in your vent.



1 - Vacuum Adapter. Connect to a shop vac to collect the lint while rotary brushing.



1 - Blockage Removal Tool. Removes heavy blockages and clears gutter downspouts.



1 - Large 2.5" dia. Lint Brush with Exceptional 42" Reach when connected to one flexible rod.

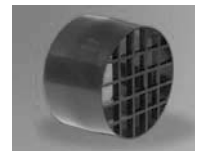

1 - Dryer/Blower Adapter. Safeguards the blower wheel by stopping the Auger Brush when using the dryer air or a blower to remove the lint while rotary brushing.

Important Safeguards!

- Read all safety & operating instructions before use.
- All warnings in the manual should be strictly adhered to.
- **Failure to comply with the instructions & safety rules may result in property damage or personal injury.**
- Retain the safety & operator's manual for future use.
- Not all vents can be cleaned. It is sometimes necessary to replace or re-route the vent system due to improper material or installation.

Important Tips

1. To ensure safe operation of your dryer, it is recommended that the dryer vent system be cleaned 3 to 4 times per year.
2. It is also recommended that lint and other debris be cleaned from behind the dryer, the back of the dryer, underneath the dryer and the entire area surrounding the dryer 3 to 4 times a year or more often if necessary.
3. The lint screen should be cleaned before every load
4. The lint screen should also be washed with hot soapy water and an old toothbrush (or other brush) at least every six months to remove the film created by dryer sheets.
5. The lint screen duct, (the area that the lint screen slides or rests into), should be cleaned once a week.

 **Caution**

- **Always** rotate the rods in the **clockwise direction** when spinning the rods **into the vent & coming back out of the vent.**
- Failure to do so will cause the rods to un-screw and disconnect.
- **Never** force the rods or over-torque the rods with the drill. Doing this may result in property damage, rod breakage or personal injury.

To avoid rod breakage

1. Only use a **drill with an adjustable clutch.** (a cordless drill is recommended)
2. Keep clutch setting on drill at halfway or lower when rotating the rods.

Safety Tips

- **Always wear eye protection & a respirator or dust mask.**
- Keep all loose clothing & objects tucked in to prevent them from being tangled around the rotating rods.
- Add one rod at a time when spinning into the vent.
- Never use the dryer to blow the lint out while rotary brushing without the included Dryer/Blower Adapter which will prevent the brush from rotating into the blower wheel of the dryer.
- Failure to use the Dryer/Blower Adapter could cause damage to the blower wheel and also to the tool.

Gardus, Inc. reserves the right to improve, change or modify the construction of the tools, including all attachments or any part thereof, without incurring any obligation to make these changes on previously delivered kits or accessories.

Limited Warranty:

The LintEater™ kit and all accessories are designed for homeowner use. All components are warranted for a period of 1 year from date of purchase. Should any part fail due to a manufacturing defect, return the defective part to Gardus, Inc. and we will replace it free of charge. A return authorization number is required prior to returning any item.

Gardus, Inc. does not warranty failure of any part due to operator error. Be sure to read all operating instructions and safety precautions before operating any of the tools.

Manufacturer accepts no liability for property damage or personal injury due to the operation of these tools and accessories. This is the full extent of the warranty made by Gardus, Inc. There is no other expressed warranty. All implied warranties are hereby excluded.

Operating Instructions

Recommended Drill

A cordless drill with a 1/2" or 3/8" chuck and adjustable clutch is recommended. However, there are a handful of drills with smaller than normal 3/8" chucks that may prevent the rods from fitting into the chuck.

In these rare cases, a drill adapter will be required. The adapter can simply be a 1 1/2" long x 5/16-18 threaded stud or bolt with the head cut off. Gardus can also provide upon request.

Setting the Clutch on your cordless drill

- Adjust clutch to a setting in the middle of the range or slightly lower.
- You should be able to hold the properly adjusted chuck with your hand & prevent it from spinning yet there should be a fair amount of torque.

Set on middle setting or lower

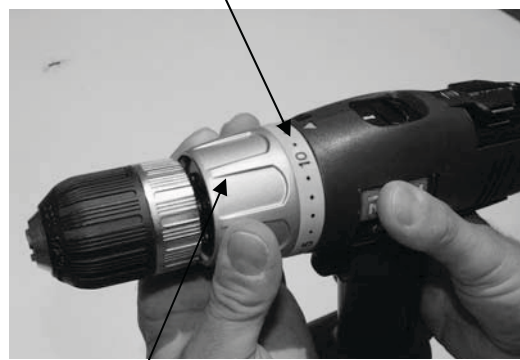

Turn to adjust clutch

Connecting the Rods

Option 1

To connect the rods, simply screw them together and tighten with two pairs of pliers. Proceed to step 4 below.

Option 2

This method requires a great deal of caution but will speed up the cleaning process.

- Start the threads by hand to insure that they are not cross-threaded.

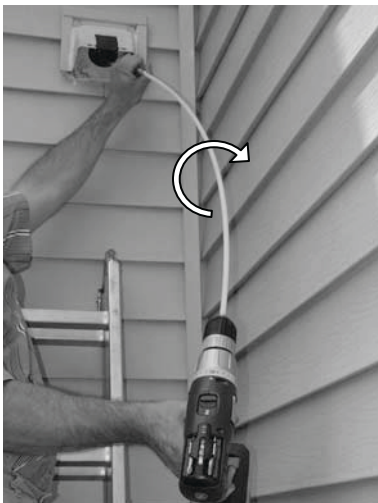
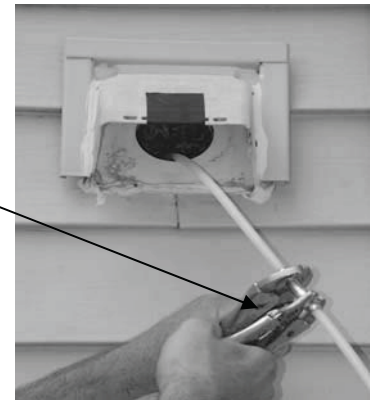

- Insert the other end of the rod into the drill chuck.
- Spin the rods clockwise while holding the rod you are connecting to.
- ALWAYS** use a small piece of electrical tape or duct tape around the joint of the fittings after tightening.



Use Electrical Tape or Duct Tape to Secure Each Connection

Important : Always spin the drill in the **Clockwise Direction** as the rods may come apart even if tightened with pliers & tape is used.

Disconnecting the Rods

Option 1

Use two pairs of pliers to loosen & then unscrew the rods by hand

Option 2

You can disconnect each rod using the drill as well.

- Hold the end of the rod, which is inside the vent, **very tightly**.
- Reverse the drill while holding the rod end to unscrew the rod which is connected to the drill.

CAUTION!

Be sure that the rods that are still in the vent do not spin as this will cause them to disconnect inside the vent.

Hold end of rod very tightly by hand or with pliers



Inserting Rods into Drill Chuck



1. The fittings on the rods are designed to fit into most types of drills without an adapter. However, as mentioned earlier, there are a handful of drills with smaller than normal 3/8" chucks that may prevent the rods from fitting into the chuck.

In these rare cases, a drill adapter will be required. The adapter can simply be a 1 1/2" long x 5/16-18 threaded stud or bolt with the head cut off. Gardus can also provide upon request.

- Simply insert the steel rod fitting into the chuck of the drill and tighten by hand

Twist chuck to tighten

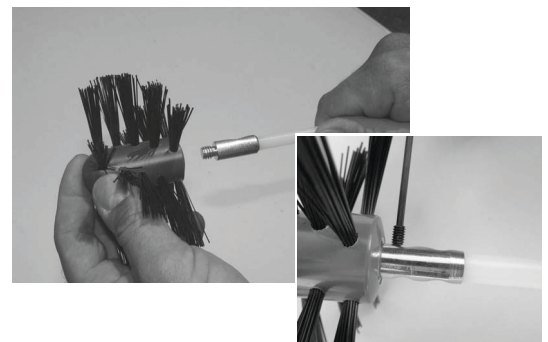

Attaching Brushes to Rods

Auger Brush:

Screw Auger Brush onto rod and tighten. Insert set screw into threaded hole in Auger Brush fitting and tighten using included hex key. (Use 8-32 x 1/8" L set screw if replacement is needed)

Lint Trap Brush:

Screw Lint Trap Brush onto rod then tighten with two pairs of pliers. Use a small piece of duct tape on joint to help reduce the risk of brush unscrewing from rod.

Important Note:

Only use the Lint Trap Brush by hand.

"Do Not Use the Drill to Spin." While cleaning with the brush by hand, rotate the rod clockwise to ensure that the brush does not loosen.



Attaching Blockage Removal Tool



1. Place the Blockage Removal Tool onto the rod.

2. Thread the included nut onto the rod.

3. Tighten with pliers or wrench.



Getting Started

Step 1

Determine what type of material was used for venting.

1. This can be done by looking into the exterior vent hood with a flashlight.
2. It can also be determined by placing the end of a FlexRod into the vent approx. 12 to 18 inches and tapping on the inside of the vent. Listen to the sound that the steel fitting on the rod makes when it contacts the inner walls of the vent.
3. White vinyl or foil venting will make a dull sound while rigid or semi-rigid venting will have a positive metal to metal sound and feel.



White Vinyl

Foil

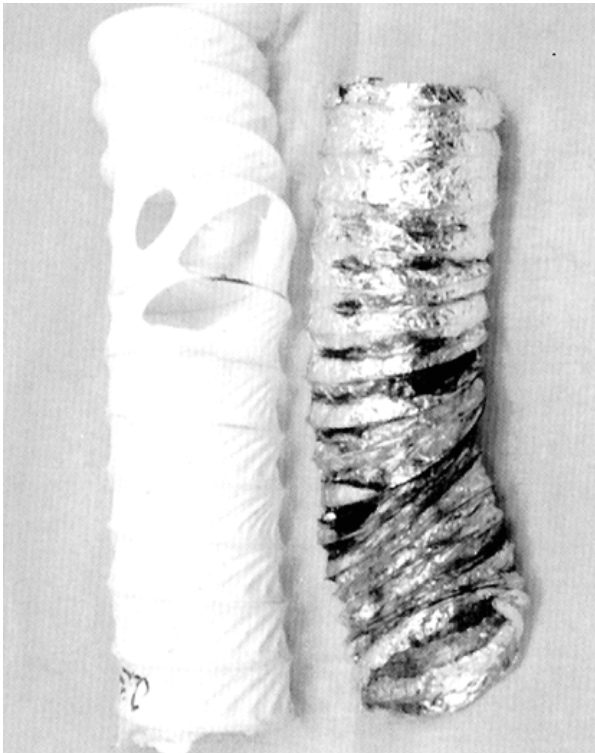

The ***LintEater*** is designed to clean all types of venting.

However, extra care must be taken when cleaning white vinyl or foil.

Caution!

White Vinyl and ***Foil*** venting should be replaced with rigid or semi-rigid **All Metal** venting if possible.

Step 2

Select a heat cycle on the dryer and then turn the dryer on.

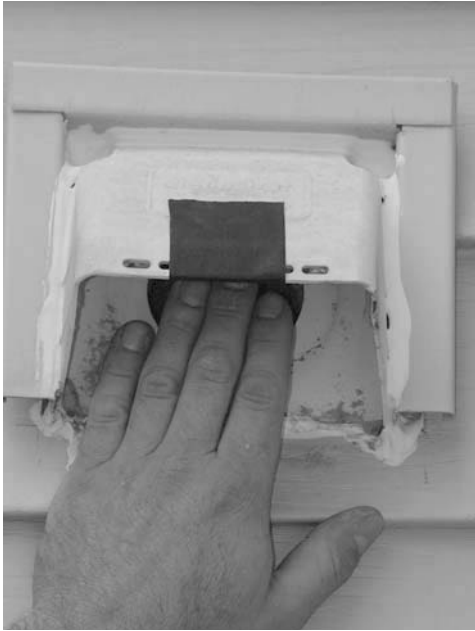

Step 3

Go to the exterior and check for air flow coming out of the vent hood.

- If there is No airflow- go to step 4.
- Yes, there is airflow- go to step 7.

Important Note:

If there is a screen over the vent hood, remove it and do not re-install as it will collect lint.



If There is **NO** Airflow

Step 4

Look for visual signs of a bird's nest such as bird droppings by exterior vent hood.

Also look for straw, leaves, twigs or anything else that is not lint inside the end of the vent.



Step 5

If there is a bird's nest or other blockage, use the "Blockage Removal Tool" to remove the blockage.

- a) Be sure that the dryer, vacuum or blower is turned OFF.
- b) Attach the Blockage Removal Tool to one of the flexible rods and insert into the vent, from the exterior, by hand.
- c) Add additional rods if necessary until you reach the blockage.
- d) Twist the rods in a clockwise direction while pushing the rods & tool into the blockage.
- e) When you have grabbed the blockage, continue to twist the rods clockwise while you pull the blockage out of the vent.
- f) Repeat this process until the Blockage Tool can be pushed freely past the problem area.



Step 6

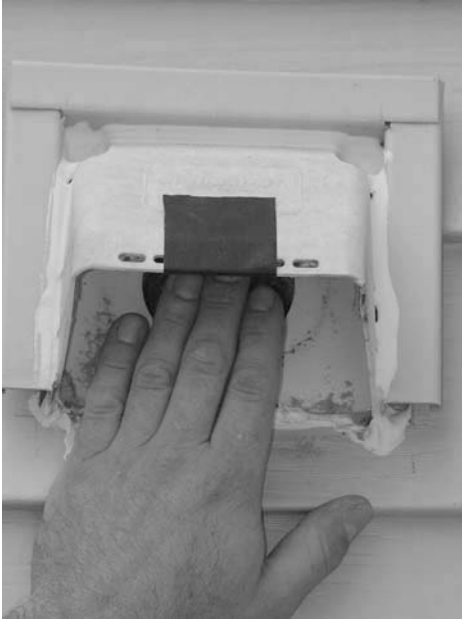

Turn the dryer on again and check the airflow at the exterior vent hood.

STILL NO AIRFLOW?

This may be caused by a more severe problem such as;

- Disconnected vent
- Crushed vent
- Torn vent pipe, etc.

Important Note

If signs of a more severe problem exist, it is recommended that a professional be called to test the system with specialized tools. Once the problem is identified, they will be able to make any necessary repairs.

If There “IS” Airflow

Step 7

Tape or clip damper on hood in the open position or remove louvers on louvered vent hood.

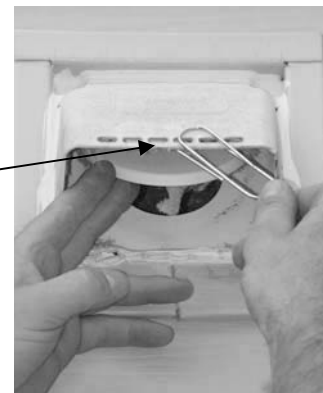
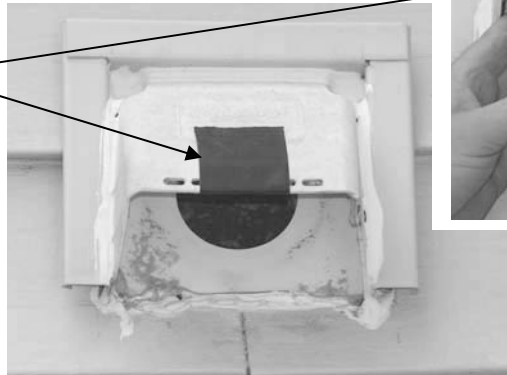

Remove the louvers by bending them slightly in the middle.

Caution!

Be careful not to break the plastic pin on the ends of the louvers.

Step 8

Go back inside to the dryer;

a) Turn dryer OFF & UNPLUG.

b) Pull dryer out carefully, especially if gas.



Step 9

Clean area behind dryer as well as the back of the dryer itself using the Lint Trap brush and a vacuum



Step 10



- Remove vent from the back of the dryer.
- Hook-up a shop vac using the included "Vacuum Adapter" or attach an electric leaf blower to vent. Attachment can be made by using a piece of duct tape.
- Be sure that the outside vent hood is taped open before turning vacuum on!

Caution!

If vent compresses when the vacuum is turned on, turn vacuum off immediately. This indicates a blockage or restriction in the vent and should be checked by a professional.



CLEANING FROM OUTSIDE WITH A CORDLESS DRILL

Step 11

Cleaning From Outside:

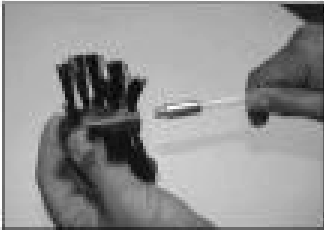

1. Thread 4" Auger Brush onto flexible rods.

2. With the vacuum/blower running, go to the exterior and begin spinning the rods & brush into the vent.

Important:

- a) Be sure the clutch is set on in the mid range (or lower). (See drill operation)
- b) **ALWAYS spin the drill in the "CLOCKWISE" direction.**
- c) Use duct tape on all Brush/Rod connections.



3. Connect one rod at a time until you reach the opposite end.

Note: If your vent is longer than the included length of rods, finish cleaning from the opposite end. (Included rods will clean up to 18' of venting when used from each end.)



4. It is recommended that you spin the drill at a moderate to high speed while using a back & forth motion.

5. If the brush binds up, stop immediately.

Important Note: Use caution and take your time to avoid breaking the rods or damaging the vent.

Never Force the Rods!
Always Spin Drill Clockwise!

CLEANING FROM OUTSIDE WITH A CORDLESS DRILL

Step 11 (cont)



6. Once you feel you have reached the end, go to the interior, disconnect the vacuum or blower and look inside the vent to see if the brush has reached the end.

If the brush is not visible, and you felt the brush binding up when you were rotary cleaning, it may be necessary to finish cleaning from the inside toward the outside.

Step 12

Removing the Rods from the Vent:

Method 1:

1. Continue to spin the rods in a clockwise direction as you pull the rods out of the vent.

2. Disconnect one rod at a time making sure not to

loosen the rods that are still inside the vent.

3. Attach the drill after disconnecting each rod to continue spinning the rods as you remove.

Note: If you need to finish cleaning the vent from the inside, count the number rods used so you can estimate how far you have reached from the outside.



Step 12

Optional Method for Removing the Rods from the Vent:

Method 2:

It's also possible to remove all of the rods at one time by spinning the rods (always in the clockwise direction) and pulling them out of the vent as you walk away from the vent hood. (providing you have the room to do so and it does not present a safety hazard to you or the surrounding area)

Try to stop when the brush reaches the vent hood. This will keep the rods & brush from falling and will prevent possible damage to the surrounding area.



Step 13

Cleaning from “Inside” toward outside:

This can be done by spinning the auger brush and rods from the inside toward the outside.

Attach the Vacuum Adapter as shown.

With the vacuum running, the loosened lint will be pulled back toward you and collected in the vacuum.



Once you feel confident that you have cleaned the vent completely, you can remove the rods and brush from the vent as mentioned earlier.

Important Note: The Vacuum Adapter is designed to fit a shop vac having a 2 ½” hose only. It is not recommended to use a shop vac or household vac having a 1 ½” hose (or smaller) since the lint being collected will continually clog the the hose.

Step 14

Remove the tape or clip from the damper or re-install the louvers if you have a louvered vent hood. Be careful not to break the pins on the ends of the louvers.

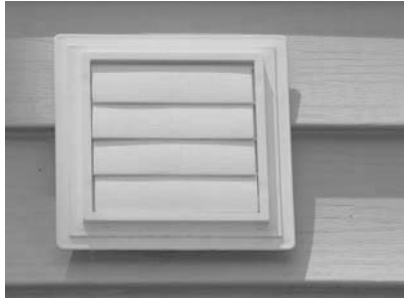

Step 15

Once the vent system is cleaned, connect the vent to the back of the dryer using the proper material. (See following section)



Step 16

Slide the dryer into place and plug the electrical cord into the outlet.

Step 17

Turn the dryer on and then go to the exterior and check for air flow. You should feel a higher volume of air coming out of the vent hood.



Connecting Dryer Vent

Replace all white vinyl or foil venting with all metal venting.

If you have white vinyl or foil venting behind the dryer or throughout the venting system it should be replaced with flexible metal or rigid metal venting.

The following are some tips to help you install flexible metal venting from your dryer to the wall or ceiling.

This section of venting is called the **transition duct**.



Example of All-Metal Venting Components
Used for Proper Installation

Installation Note:

When installing venting components, the male end or (crimped end) must always face toward the exterior. This holds true for the entire venting system.

Note: The following are only tips to help you with the installation.

It may be necessary to call a professional to **ensure proper installation.**

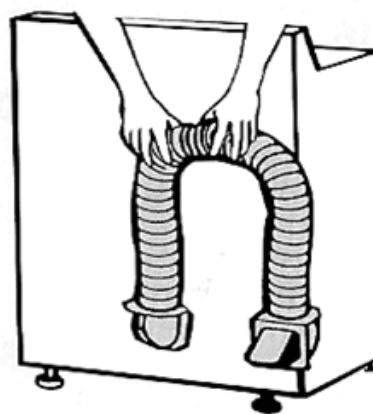

“Loop” Method:

When used with the proper materials, this method will allow you to connect the venting to the dryer while it is pulled away from the wall. It will form a rounded transition from the dryer to the connection point of your venting system which, in many cases, is in the wall or floor.

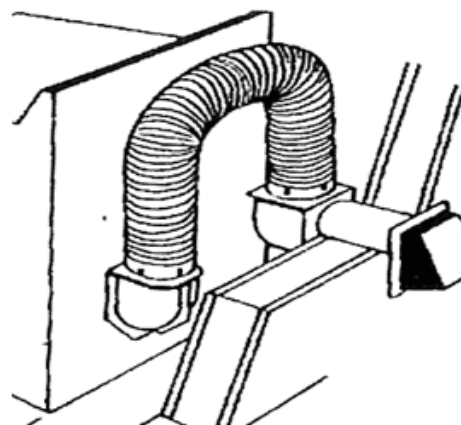

Additional Cleaning Methods

Method 1

Using the dryer to blow the lint out while rotary brushing

The “**Dryer Adapter**” has a built-in guard to prevent the rotating Auger Brush from entering the dryer thus preventing damage to the blower wheel within the dryer.

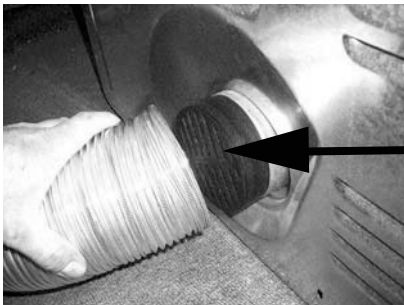
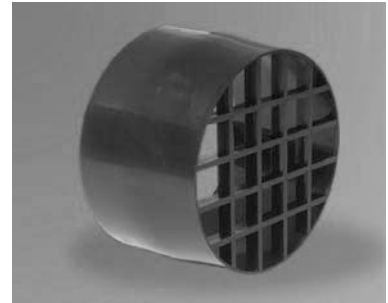

a) Place the **Dryer Adapter** on the back of the dryer.

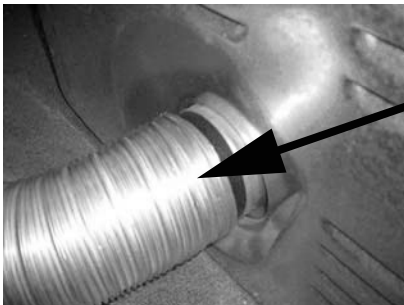

b) Connect the vent to the adapter and secure with duct tape.

c) With the dryer running, go to the exterior and begin rotary brushing from outside as described earlier.

Important: Be sure to remove the Dryer Adapter when you have completed the cleaning as it will collect lint if left in place during normal operation of the dryer.

Note: Eye protection & a respirator must be worn as the loosened lint will be blown out toward you.



Additional Cleaning Methods

Method 2

Using an Electric Leaf Blower to blow the loosened lint out of the vent while rotary brushing from outside



An electric blower can also be attached to the vent on the inside to blow the lint out while you rotary brush from the outside toward the inside.

Important Note:

- a) Connect the Dryer Adapter between the blower & vent to prevent the brush from entering into the blower.
- b) Always wear eye protection & a respirator.

Method 3

Rotary brushing from outside with vacuum connected outside

This is not a preferred method but the cleaning can be done this way.

Important Note: Only use this method with the **Dryer Adapter** installed at the opposite end of the vent on the interior. This will stop the brush when it reaches the end of the vent.



Additional Cleaning Methods

Method 4

Rotary brushing from inside with vacuum connected outside

- a) Connect the vacuum hose to the exterior vent hood.
- b) Rotary brush from the inside toward the exterior while the vacuum collects the loosened lint on the outside.



Method 5

Cleaning by Hand from the Inside or Outside

- a) Thread 4" Auger Brush onto flexible rods.



4. Rotate rods in a clockwise direction while using a back and forth motion to remove the lint from the dryer vent.

Included rods will clean 18' of venting when used from each end.

Note: A shop vac, electric leaf blower or the air from the dryer should be used to remove the loosened lint while brushing the vent.

Cleaning Lint Trap & Lint Screen Duct

Works for dryers with lint screens in the “Top” of the dryer (as shown) & for dryers with lint screens inside the front door!

1. Always “scoop” the lint up toward you when clean the lint trap area.
2. Use a vacuum to remove the lint from the brush as you pull the lint up & out of the Lint Trap.



Bend brush for more versatility

Clean the Dryer Interior



Although cleaning the dryer vent system is extremely important, it is equally important to clean the inside of the dryer as well. Only attempt this if you are familiar with taking dryers apart. Otherwise, it is recommended that a professional be called to periodically clean & inspect the interior of your dryer.

Cleaning baseboard heat or under refrigerator with the *Lint Brush*

Baseboard Heat:

Works great to remove the dust buildup on the fins inside your baseboard heat. Simply run the brush over the fins while rotating the brush clockwise. Use a vacuum to clean the brush as you go. Be careful not to damage the fins.



Under the Refrigerator:

When attached to one or more FlexRods, the lint brush also works great for cleaning out the debris from under the refrigerator or any hard to reach areas around your home.

Use Blockage Removal Tool for clearing “Gutter Downspouts”

- Attach the **Blockage Removal Tool** to a rod as mentioned earlier
- Feed the first rod with the tool up into the bottom of the downspout.
- Continue to add rods until you reach the blockage.
- Use your hand or the drill to rotate “**Clockwise**” into the blockage until it is cleared.

The tool can also be used from the top as well.



What to do if the rods disconnect in the vent



If you accidentally reverse the drill or rotate the rods “counter clockwise” by hand, the rods may disconnect leaving some of the rods and the brush inside the vent.

Although this rarely happens, we have designed a “Retrieval Tool” to grab the brush and pull it out. It attaches to your remaining rods and is used by hand without the drill.

To obtain this tool, please contact us at:

sales@gardus-inc.com

Phone: 203.985.0208

Additional Products from **Gardus**[®] INC.

12' Extension Kit

Adds to your **LintEater**[®] Rotary Dryer Vent Cleaning System for vent runs longer than 12 feet.

Includes: 4 - 3' long Flexible Rods

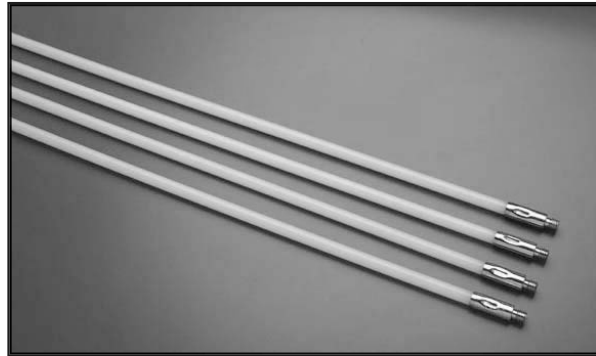

LintCatcher[®]

Captures loosened lint from the dryer vent while rotary brushing with the **LintEater**[®] System!

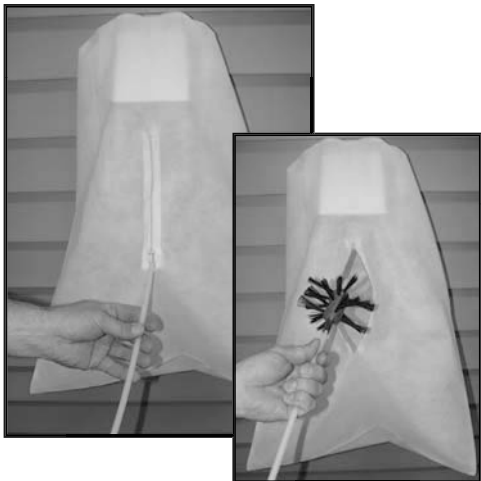

Simply attach the LintCatcher™ to the exterior vent hood, turn on your blower or dryer and begin rotary brushing the vent system.

As the loosened lint is blown out by the blower or dryer air, it is collected in the LintCatcher™ making your job clean and hassle free.

Works great when cleaning from the outside or from the inside!

Easy to use



Attach the clips



Position LintCatcher over the vent



Secure with drawstring

How to Purchase Accessories & Spare Parts

If you would like to purchase additional accessories or spare parts, please go to www.lint eater.com then click on the “Where to Buy” tab.

Thank You

Gardus, Inc.

888-985-0208 (toll free) • sales@gardus-inc.com • www.gardusinc.com

Made in China