

Instructions to Users

Precautions 1

Motorcycle Vehicle Identification Number (VIN)and Engine Number2

Brief Introduction to the Whole Motorcycle..... 3

Technical Specifications and Performance Parameters 6

Instrument combination 8

Left combination switch 9

Right combination switch 10

Ignition lock switch 11

Fuel tank Fuel tank 12

Maneuvering positions 14

Environmental protection device 15

Motorcycle Load..... 16

Tools delivered together with the motorcycle 16

Operating Instructions

Check before Running 17

Operation of foot-stepped startup..... 21

Operation of electric startup 22

Operation of left combination switch 23

Operation of right combination switch 24

Parking of the Motorcycle..... 25

Service and Maintenance

Regular Service and Maintenance 27

Requirements on Service and Maintenance 27

Service and Maintenance in the Run-in Period 27

Precautions for the run-in period of a new motorcycle 28

Contents of Level 1 Service and Maintenance 28

Contents of Level 2 Service and Maintenance 29

Contents of Level 3 Service and Maintenance 29

Service and Maintenance for the Carburetor..... 30

Check and Replacement of Lubricant 31

Service and Maintenance of the Spark Plug..... 32

Service and Maintenance for the Air Filter 33

Adjustment of the accelerator handgrip..... 34

Service and Maintenance for the Front Brake 34

Service and Maintenance for the Rear Brake..... 36

Adjustment of the rear braking light..... 37

Adjustment of the idle speed..... 37

Service and Maintenance for Front and Rear Tires..... 38

Service and Maintenance for Environmental Protection Device..... 40

Service and Maintenance for the Accumulator Cell..... 41

Service and Maintenance for Fuse..... 42

Service and Maintenance for the Horn..... 42

Storage of the Motorcycle 43

Service and Maintenance Interval Table..... 44

Service and Maintenance Interval Table for Lubricated Parts 45

Common Faults and Troubleshooting..... 46

Schematic Wiring Diagram 50

Precautions

Please read this User's Manual carefully before operating this product!

▲ Warning

- * Please observe traffic laws and regulations carefully and drive safely.
- * Make sure not to lend this motorcycle to be driven by a person not holding a driver's license.
- * Make sure not to hang anything on the direction handgrip, otherwise the driving safety may be affected.
- * Please wear your protective articles such as helmet, dust goggles, gloves for the sake of your safety.
- * Make sure not to use this model to participate in any kind of competition. Otherwise, any mechanical breakdown, injury or death arising wherefrom shall be on your own account.
- * The temperature of exhaust silencer is high when the motorcycle is running. Drivers shall be careful not to touch it to burn them.
- * Don't wear loose clothes or slippers when driving it. Otherwise, it may hook the control grip and accessories, and thus cause potential safety hazards.

▲ Caution

- * After opening the packaging box, please check the accessories and various documents delivered with the motorcycle according to the packing list.
- * The motorcycle accommodates two persons, and the maximum payload is 150kg. The moped accommodates 1 person, and the maximum payload is 75kg.
- * It is not allowed to modify any part of the motorcycle. Otherwise, the reliability, stability and comfortableness of the motorcycle may be affected.
- * Only the fuel with a grade specified on the fuel tank or above can be used. Otherwise, the dynamic performance, economy, and safety of the motorcycle may be damaged, and the service life of the motorcycle will be shortened. If any mechanical breakdown occurs due to this, you shall be solely responsible for it.

▲ Suggestion

- * This Manual is a necessity for the use of the motorcycle. If the motorcycle is transferred to any other person, this Manual should be transferred together with the motorcycle.
- * When it is necessary to adjust the air valve clearance of the motorcycle, please do it in a professional motorcycle maintenance shop or in a designated after-sales service center.

Motorcycle Vehicle Identification Number (VIN) and Engine Number

Motorcycle Vehicle Identification Number (VIN), Engine Number and Quality Certificate, used for obtaining the motorcycle driving license and motorcycle registry



① The motorcycle Vehicle Identification Number (VIN) is printed on the vertical tube of the frame.



② The product nameplate is riveted on the right lower part of the frame.



③ The Engine Number is printed on the left lower part of the crankcase.

Please fill in appropriate numbers for future reference:

Motorcycle VIN:

Engine Number:

Brief Introduction to the Whole Motorcycle

- ①. Head Light
- ②. Left front turn light
- ③. Tail light
- ④. Seat cushion
- ⑤. Rear carrier
- ⑥. Disc brake
- ⑦. Side support
- ⑧. Main support
- ⑨. Starting arm
- ⑩. Air filter



Brief Introduction to the Whole Motorcycle

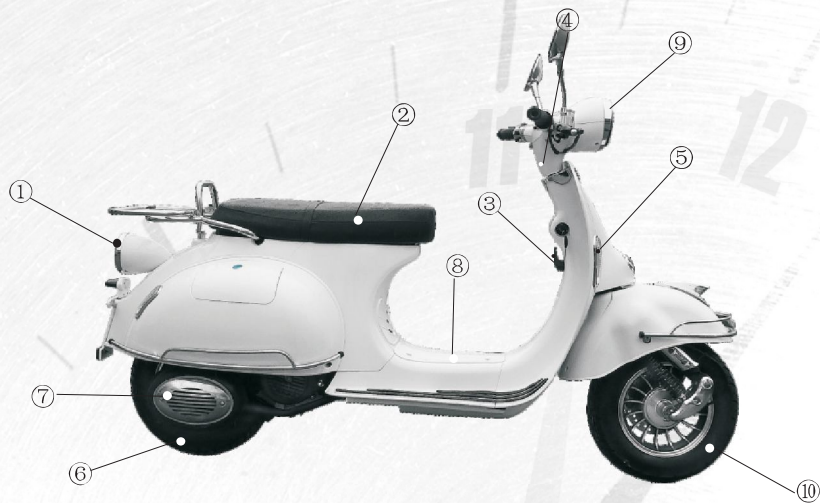

- ①. Tail light
- ②. Storage box
- ③. Helmet hook
- ④. Steering gear
- ⑤. Right front turn light
- ⑥. Rear wheel
- ⑦. Silencer
- ⑧. Accumulator cell
- ⑨. Front braking handgrip
- ⑩. Front wheel

Brief Introduction to the Whole Motorcycle

- ①. Rearview mirror
- ②. Left handgrip
- ③. Left combination switch
- ④. Instrument combination
- ⑤. Ignition lock switch
- ⑥. Right combination switch
- ⑦. Accelerator handgrip

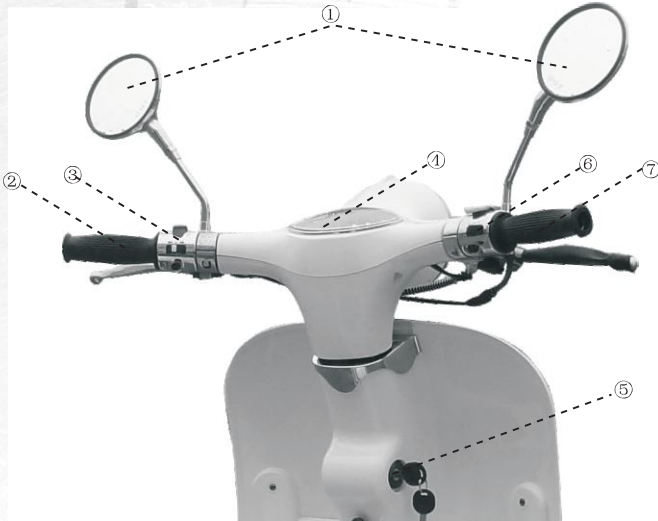

Technical Specifications and Performance Parameters

Item		Specification	
Displacement		50cc	125cc
Overall dimensions(L*W*H)		1865mmx770mmx1060mm	1885mmx770mmx1060mm
Wheelbase		1325mm	1360mm
Minimum ground clearance		95mm	110mm
Complete vehicle shipping mass		90kg	99kg
Maximum payload		75kg	150kg
Engine model		139QMB	152QMI-6
Engine form		Single-cylinder, four-stroke, air-cooled	
Engine	Bore×Stoke	39mm×41.5mm	52.4mm×57.8mm
	Working volume of cylinder	49.6mL	124.6mL
	Compression ratio	10. 2: 1	9. 2: 1
	Model of carburetter	PD18J	PD24J
	Air filter	Sponge filter element	
	Method of lubrication	Force-feed and splash	
	Startup way	Foot-stepped /electric start-up	
	Maximum power/corresponding speed	2.20kw/7500r/min	5.7kw/7500r/min
	Maximum torque/corresponding speed	2.90N.m/6500r/min	8.0N.m/5500r/min
	Minimum idling stabilized speed	(1600± 100)r/min	
Economic fuel consumption	2.0L/100km	2.8L/100km	
Travelling system	Model of shock absorber	Hydraulic spring combined type	
	Drive mode	Belt drive	
	Specification/air pressure of tire	Front wheel 3.50x10 175kpa	Rear wheel 3.50x10 225kpa

Technical Specifications and Performance Parameters

Item		Specification	
Displacement		50cc	125cc
Drive system	Clutch type	Dry-type automatic centrifugal	
	Transmission type	Automatic	
	Front wheel type	Aluminum alloy wheel	
	Continuous transmission ratio	1.5-0.6	2.66 - 0.866
	Fixed transmission ratio	13.122	8.615
Braking system	Front brake	Disc brake	
	Rear brake	Drum brake	
Electric system	Ignition way	CDI	
	Model of spark plug	CR7HSA	
	Spark plug gap	0.6mm~0.7mm	
	Specification of accumulator cell	12V7Ah	
	Fuse	15A	
	Head Light	12V 35W/35W X2	
	Tail light/Braking light	12V 10W/21W	
	Turning signal light	12V10W×4	
	Turn signal indication lamp	12V 3W×2	
Fuel & oil	Instrument light	12V 3W×2	
	Front Position Lamp	12V3W	
	Fuel tank	6.7L	
	Engine oil	800mL	

Instrument combination

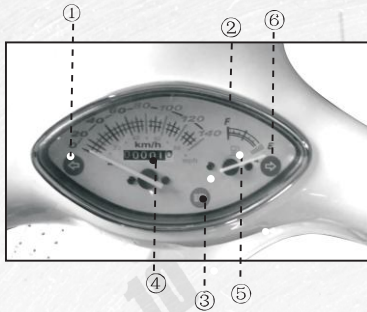

- ① Left turning indicator lamp:

When the turning indicator lamp “” flashes, it indicates that “Turning signal light” is open.

- ② High beam indicator lamp:

When the high beam indicator lamp “” is on, it indicates that the “High beam lamp” is on.

- ③ Speedometer:

It indicates the current driving speed of the motorcycle.

- ④ Odometer:

It records the accumulative travel miles of the motorcycle.

- ⑤ Fuel gauge:

It indicates how much fuel is left in the fuel tank of the motorcycle.

- ⑥ Right turning indicator lamp:

When the right turning indicator lamp “” flashes, it indicates that the “Right turning signal light” is on.

Left combination switch

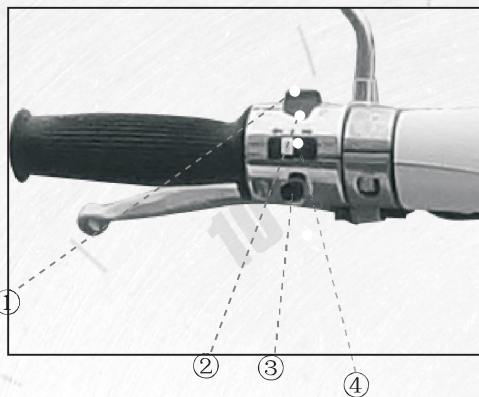

- ① High beam lamp switch:

When the motorcycle needs to use the "High beam lamp", turn the lighting switch to the status "☰☞".

- ② low beam lamp switch:

When the motorcycle needs to use the "Low beam lamp", turn the lighting switch to the position "☰☞".

- ③ Horn button:

When the motorcycle needs to horn, press the button "🔊".

- ④ Turning signal light switch:

When the motorcycle needs to change its travelling direction, switch to "☞" or "☞" to turn left r right. When the motorcycle needs to stop turning, simply switch the turning button to the middle.

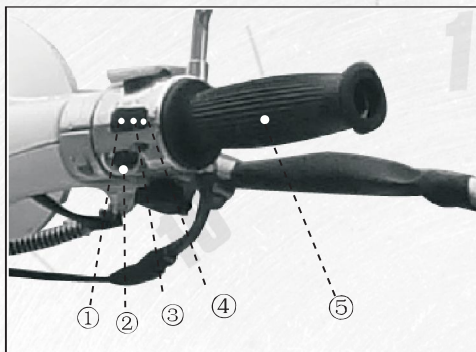
Right combination switch**① Head Light switch:**

Turn the "Head Light switch" to the position "☀️", the high beam and low beam of the head light is open.

② Electric start button:

When the motorcycle needs electric start, press the button "🔌".

③ Position lamp switch:

Turn the "Head Light switch" to the position "🚦", the position lamp of instruments, head light and tail light are open.

④ Main switch of lighting lamps:

Turn the "Head Light switch" to the position "●"; the lighting system of the motorcycle is closed.

⑤ Accelerator handgrip:

It is mainly use to control the fuel flow rate of the carburetor.

Ignition lock switch

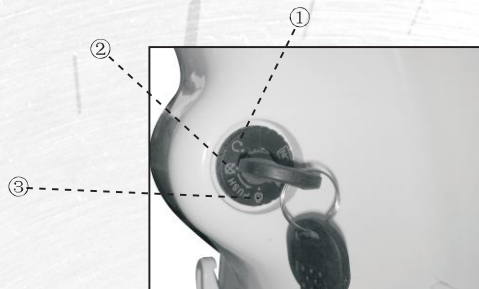

① Ignition lock On:

Turn the ignition lock key to the position “” to switch on the electrical system of the motorcycle. Don't remove the motorcycle key.

② Ignition Lock Off:

Turn the ignition lock key to the position “” to switch off the electrical system of the motorcycle. The motorcycle key can be removed.

③ Direction lock:

Turn the steering gear left to the flameout position. Turn the ignition lock key to the position “” to lock the direction lock. Remove the ignition lock key.

Caution

* When the motorcycle is parked, please turn the Ignition lock switch to “” to lock the direction lock, so as to prevent the motorcycle from being stolen.

Front storage box

No Front storage box

Seat cushion lock



Seat cushion: Insert the ignition lock key into the seat cushion lock and turn it 90° clockwise to open the seat cushion.

Fuel tank

The capacity of the fuel tank is 6.7L.

Open the fuel tank cover: To open the fuel tank cover, turn the fuel tank cover 90° anticlockwise to remove the fuel tank cover.



Close the fuel tank cover: Align the convex on the fuel tank cover with the concave for fuel filling, and turn it clockwise.

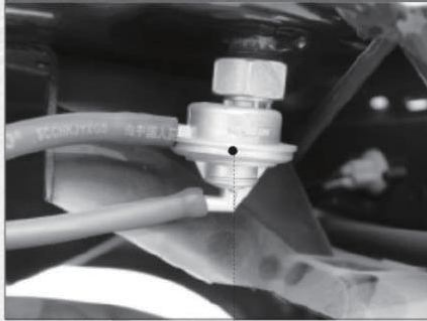

Fuel tank negative pressure switch: it is opened mainly relying on the negative pressure produced by the operation of the engine, so as to make fuel enter the carburetor.

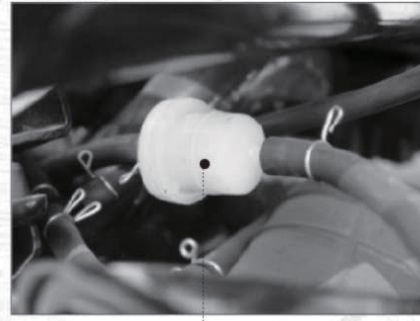

Fuel filter: fuel must be filtered through a fuel filter, to ensure that it is clean.

Warning

- * Don't fill fuel to be above the neck of the fuel tank.
- * Gasoline is flammable. The motorcycle should flame out before opening the fuel tank cover. Fuel should be filled in a ventilated place.
- * Fuel should be filtered in filling fuel. In filling fuel, smoking should be strictly forbidden and it should not be close to any open fire.

Caution

- * Only Grade 90 or above fuel should be used.

Maneuvering positions

This model adopts a dry-type automatic centrifugal clutch, namely automatic clutch, stepless speed change plus constant mesh. If any slip or incomplete separation occurs to the stepless speed change of the automatic clutch, please repair it in a designated after-sales service center or in a professional maintenance station.



Front braking handgrip: controls the running speed of the front wheel of the motorcycle.

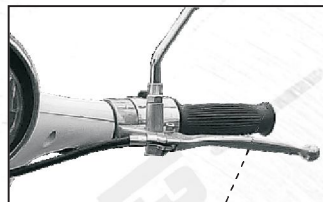

Rear braking handgrip: controls the running speed of the rear wheel of the motorcycle.

Starting arm: used for foot-stepped startup of the motorcycle

Automatic clutch: automatically controls the separating/meshing of the clutch based on the running speed of the motorcycle.

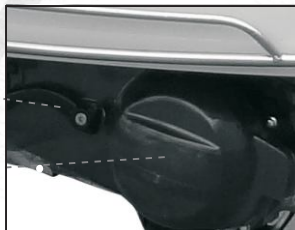

Environmental protection device

The environmental protection device is mainly a two-in-one air compensating valve (air pump) combining a one-way leaf valve and a secondary air control valve. Fresh air enters the exhaust passage of the engine under the action of the air pump to perform second burning for unburned gas discharged from the engine. By making use of the principle of negative pressure pulsation, the air pump controls the amount of air needed to enter into the exhaust port through the one-way leaf valve and the secondary air control valve. This device reduces the emission pollution of the motorcycle, and ensures that the tail gas of the motorcycle can meet the requirements of National Stage III emission standard.

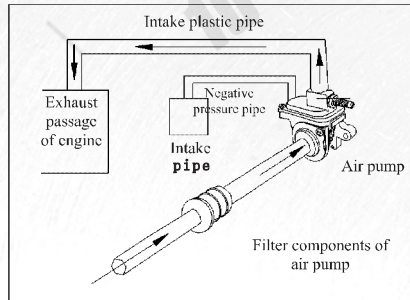

Emission Standards of Motorcycles (Stage III , under the running mode)

Unit:g/km

Emitted pollutants	Two-wheel motorcycle
CO	2.0
HC	0.8
NOx	0.15

Emission Standards of Mopeds (Stage III , under the running mode)

Unit:g/km

Emitted pollutants	Two-wheel moped
CO	1.0
HC + NOx	1.2

Limits of exhaust pollutants of motorcycle/mopeds under idle conditions

In case of idle type approval test, the volume concentration of emitted CO is $\leq 3.8\%$; and the volume concentration of emitted HC is $\leq 800 \times 10^{-6}$;

In case of Production consistency check test, the volume concentration of emitted CO is $\leq 4.0\%$; and the volume concentration of emitted HC is $\leq 1000 \times 10^{-6}$.

Motorcycle Load

The required load of the motorcycle must be strictly observed. Otherwise, the safety and stability of the motorcycle may be affected.

- * Articles in the rear storage box must be securely fixed.
- * It is strictly forbidden to hang anything on the steering gear.
- * The load of the rear carrier must not exceed 75kg.
- * The maximum payload of motorcycles is 150kg, and the maximum payload of mopeds is 75kg.



The load of the luggage carrier should not exceed 5kg

Tools delivered together with the motorcycle

Common service and maintenance tools are delivered together with the Motorcycle.



Tools delivered together with the motorcycle can be accessible simply by opening the seat cushion storage box.

13×15 Double-ended spanner Spark plug socket Double-ended screw



8×10 Double-ended spanner Double-ended screw driver holder

Check before and after running

In order to ensure good working performance of the motorcycle, please conduct service and maintenance mainly by checking, adjusting and cleaning the Motorcycle before, during and after the running of the motorcycle.

1. After cleaning the Motorcycle, start the engine and make it run at idle for several minutes.
2. Check whether there is any fuel/oil/gas leakage.
3. Check whether there is any loose connection.

Different levels of maintenance and service will be taken for different odometer readings and performance conditions of the motorcycle:

Level 1 Service and Maintenance: Odometer reading 1000km~2000km, the service and maintenance is dominated by lubricating and fastening.

Level 2 Service and Maintenance: Odometer reading 3000km~6000km, the service and maintenance is dominated by checking and adjusting.

Level 3 Service and Maintenance: Odometer reading 6000km~10000km, the service and maintenance is dominated by disassembling, disassembly inspection and removing hidden hazards.

Before running the motorcycle, please follow the following steps to check it, so as to ensure good performance of the motorcycle and your driving safety.

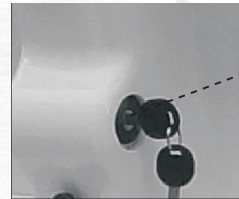

Start the ignition lock switch to check whether each indicator lamp of instrument works properly.

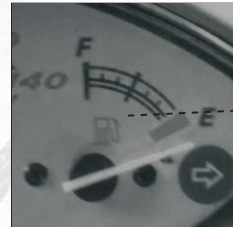

Observe the fuel gauge to see whether the remaining fuel is enough.



Open the fuel tank cover, and add fuel according to the actual travel miles.



Check the flexibility and stability of the steering gear.



Level the motorcycle and check the oil gauge to see whether the oil level is between the upper and lower markings.

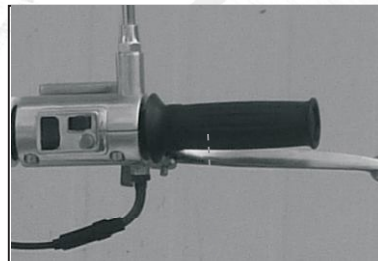

Check whether the acceleration handgrip turns flexibility. If not, it is necessary to clean the accelerator or change the steel cable.

USER'S MANUAL



Check whether the clutch separates or meshes properly.



Check the air pressure of the front tire and the wear of the tire casing.

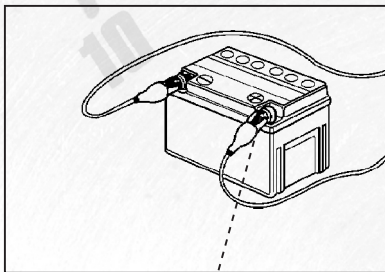

Check whether the connection of the accumulator cell is loose



Check the air pressure of the rear tire and the wear of the tire casing.

USER'S MANUAL

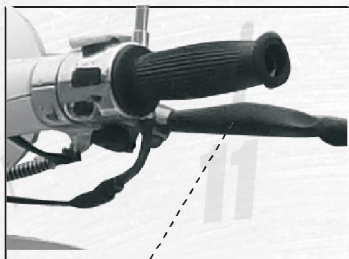

Check whether the free travel of the front braking handgrip meets the standard 10mm-20mm.



Check whether the head light, turning lights and indicator lamps work properly.

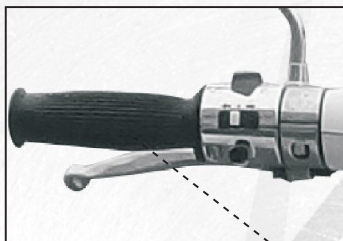

Check whether the free travel of the rear braking handgrip meets the standard 10mm-20mm.



Check whether the tail light and braking lights work properly.

Operation of foot-stepped startup

The foot-stepped startup of the motorcycle is done in the following steps:

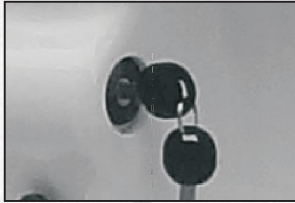

Start the ignition lock to check whether indicator lamps of instruments of the motorcycle work properly.

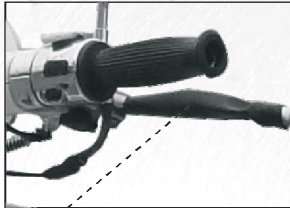

Hold the front braking handgrip to prevent the slipping of the motorcycle.



Step down the starting arm to its limit, and then reset the starting arm in time. The starting arm must be reset in time after the startup of the motorcycle.

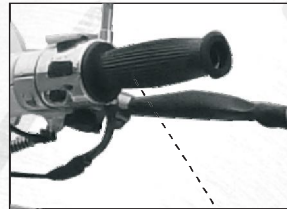

Turn the acceleration handgrip slightly with your right hand to add an appropriate amount of fuel to start up the motorcycle. The motorcycle can be run only after it is re-heated.

Operation of Electric Startup

The duration of each electric startup should not exceed 5s, and each interval between two electric startups should not be shorter than 10s. If 3 startup attempts fail consecutively, the motorcycle must be checked.

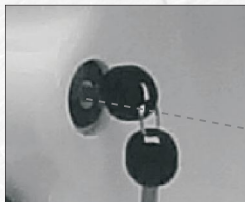

First, insert the key into the ignition switch lock, and turn it to the position "⌚".

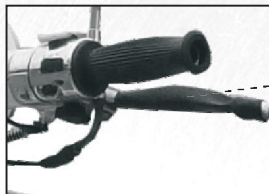

Hold the front braking handgrip, turn on the electric startup switch and perform electric startup.

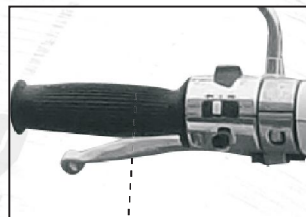

Or hold the rear braking handgrip, turn on the electric startup switch and perform electric startup.







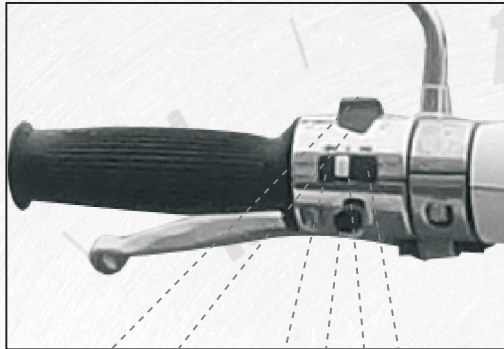

Push the electric startup button with your right thumb, and meanwhile turn the acceleration handgrip slightly with your right hand to add an appropriate amount of fuel.

Operation of Left Combination Switch



① ② ③ ④ ⑤ ⑥

- ① When the motorcycle runs at night and needs to see clearly a target in the distance, turn the lighting switch to the position “”, and the High beam lamp begins to work.
- ② When the motorcycle runs at night and meets another vehicle, in order to ensure the safety of both parties, turn the lighting switch to the position “” and the low beam lamp begins to work.
- ③ When the motorcycle needs to turn left, turn the turning light switch to the position “”, and the left turning light begins to work.
- ④ When the motorcycle needs to overtake another vehicle or warn pedestrians, push down the Horn button “” to warn them.
- ⑤ Turn the turning light switch to the position “”, both left and right turning signal lights stop working.
- ⑥ When the motorcycle needs to turn right, turn the turning light switch to the position “”, and the right turning light begins to work.

Operation of Right Combination Switch

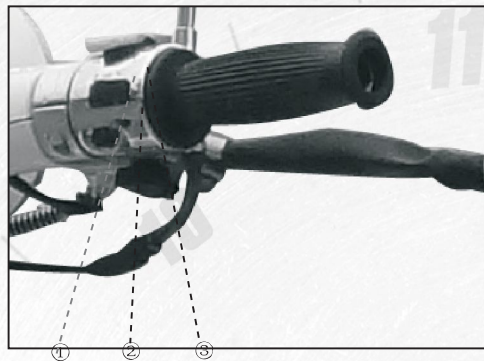

- ① When the motorcycle needs to run at night, turn the lighting switch to the position "☀️", and the Head Light is on.
- ② When the motorcycle needs electric startup, push the button "🔌" to switch on the electric startup system and then electric startup can be done for the motorcycle. You may refer to the operating procedures of electric startup described in this Manual.
- ③ When the motorcycle needs to use its position lamp, tail light and instrument indicator lamp, turn the lighting switch to the position "🚦", and the position lamp, tail light and instrument indicator lamp begin to work.

Parking of the Motorcycle

When the motorcycle needs to be parked temporarily, it should be parked in a relatively safe place. Please pay attention to the following points in parking the motorcycle:

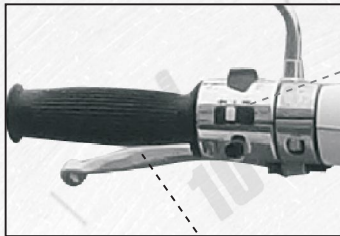

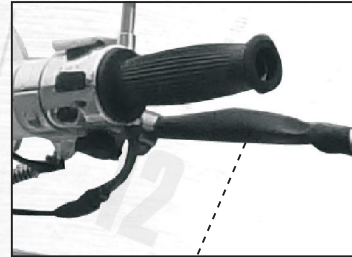

Hold the rear braking handgrip to reduce the speed of the rear wheel.

Turn on the right turning light to warn surrounding vehicles and pedestrians.

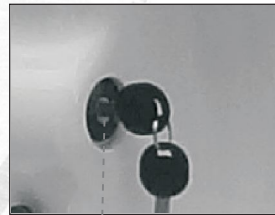

At the same time, hold the front braking handgrip to reduce the speed of the front wheel.



Turn the ignition lock key to the position “” to shut off the ignition system and stop the motorcycle.

After parking the motorcycle, put up the side support as shown in the figure. The front wheel of the motorcycle must be towards an uphill direction so as to prevent the slipping of the motorcycle.

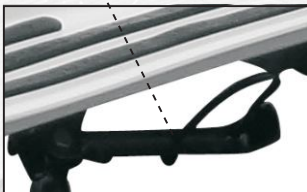

Then put up the main support. At the same time, the front wheel of the motorcycle must be towards an uphill direction so as to prevent the slipping of the motorcycle.



Turn the ignition lock switch to the position "🔒" to prevent the motorcycle from being stolen.

⚠ Caution

- * After parking the motorcycle, the direction lock should be locked and the ignition lock key should be removed, so as to prevent the motorcycle from being stolen.

Regular Service and Maintenance

During the operation of the motorcycle, different levels of loosening and mechanical wear will occur to each part. Without regular service and maintenance, the dynamic property, economy, reliability and security of the motorcycle will be reduced, and the service life of the motorcycle will also be shortened. Therefore, motorcycle drivers must conduct proper regular service and maintenance for the motorcycle, so as to ensure best performance of the motorcycle. Proper regular service and maintenance can remove faults in time, prolong the service life of the motorcycle, reduce the maintenance costs and realize the goal of safe driving of the motorcycle.

Requirements on Service and Maintenance

There are following requirements on the service and maintenance of the Motorcycle:

1. Keep the engine clean, and make sure there is no gas/oil leakage and the engine is easy to start up and has good acceleration property and dynamic property and has no abnormal noise.
2. Ensure that the automatic clutch separates thoroughly and meshes smoothly, and shows no slipping or abnormal noise, and the accelerator handgrip operates flexibly.
3. Ensure handy and flexible operation of the braking handgrip, and ensure that the braking results meet relevant requirements. After the brake is released, the brake should be able to be reset automatically, and show no friction sound. Ensure good lubricating performance of the motorcycle.
4. The front and rear shock absorbers should work properly and reliably. The air pressure of the tire should be normal, and the electrical components at each part should be able to work properly.
5. There is no loose connection on the overall motorcycle. The appearance of the overall motorcycle should be clean and tidy.
6. It is well lubricated and there is no oil leakage at each lubricated part.
7. The connection of the accumulator cell should not be loose. It should be secure and reliable.
8. Tools delivered together with the motorcycle, as well as spare parts should be complete, free from wear or corrosion.

Service and Maintenance in the Run-in Period

The run-in of a new Motorcycle directly affects the service life of the motorcycle. Within the first 1000km of a new Motorcycle (the driving speed should not exceed 40km/h, subject to the speedometer), overspeed should be avoided. Run-in must be carefully performed, and service and maintenance should be conducted after the run-in, with a view of compensating the initial light wear. In this way, we can prolong the service life of the engine, and ensure best conditions and good performance of the motorcycle.

Precautions for the run-in period of a new Motorcycle

1. Within the run-in period, replace the oil every 500km, and clean the oil filter screen.
2. Regularly check whether each connection is loose, and tighten it timely if any loosening is found.
3. Regularly check whether the engine, drive system and braking system is overheated, and whether there is enough lubricating oil on each lubricated part. If any overheat occurs, the cause should be found in time and be removed timely.
4. Regularly check the tightness of the belt, and the free travel of the front and rear brakes, accelerator handgrip and each maneuvering position. Adjust them if necessary.
5. Within the run-in period, run the motorcycle after the engine is well pre-heated. First run it at low speed for 1km~2km, and then run it at high speed.
6. In order to reduce vibration and impact loads, the motorcycle should run on a level road with good road conditions whenever possible.
7. Within the run-in period, overload run should be strictly forbidden. Otherwise, the drive system will wear more faster. Heavy load should be avoided.
8. Avoid emergent and long-time braking.
9. Strictly control the running speed of the motorcycle.
10. Within the run-in period, the load should not exceed 80% of the payload.

Contents of Level 1 Service and Maintenance

Level 1 Service and Maintenance should be performed every time after the motorcycle runs 1000km~2000km. Its main contents are as follows:

1. Adjust the travel of the front braking handgrip to 10mm~20mm, and adjust the rear brake pedal to 20mm~30mm.
2. Adjust the travel of the accelerator cable to 2mm~6mm, and lubricate the accelerator handgrip and the accelerator cable.
3. Clean the carburetor, fuel tank, oil filter screen and air filter.
4. Adjust the idle speed of the carburetor and put the motorcycle in best conditions.
5. Remove the carbon deposit of the spark plug, and adjust the electrode gap of the spark plug to 0.6mm~0.7mm.
6. Remove the accumulator cell and charge it.
7. Check and tighten all bolts and nuts of all exposed parts.
8. Check the tightness of all connections of the electric system, and tighten them timely.
9. Adjust the engine valve lash: intake valve 0.03-0.05mm; exhaust valve 0.05-0.07mm.

Contents of Level 2 Service and Maintenance

Level 2 Service and Maintenance should be performed every time after the motorcycle runs 3000km~6000km. Its main contents are as follows:

1. Remove the carbon deposit on the parts such as cylinder, piston, piston ring, cylinder head and silencer, and clean them.
2. Check the wear of the cylinder, piston and piston wear. Check whether the compression ratio of the cylinder falls within the range of standard values.
3. Check the wear of the clutch friction lining and brake shoes. Replace them in time if any serious wear is found.
4. Clean the carburetor, air filter, fuel tank, fuel filter, etc.
5. Clean the upper and lower steel balls of the steering column, and fill lubricating oil or grease.
6. Check whether the axial and radial runout of the front and rear wheel meet applicable requirements, and adjust it if necessary.
7. Clean, lubricate, service and maintain the controller cables of the whole motorcycle. Check the wear of controller cables, and replace them if necessary.
8. Clean the rear transmission box and replace the lubricant in it if necessary. Check the wear of the front clutch friction lining, rear clutch friction lining and drive belt. Replace them if necessary.
9. Wipe off dust on the rearview mirror with lint, and check whether the rearview mirror is properly located.
10. Check whether the electrical components of the whole motorcycle can work normally.

Contents of Level 3 Service and Maintenance

Level 3 Service and Maintenance should be performed every time after the motorcycle runs 6000km~10000km. Its main contents are as follows:

1. Ensure normal oil supply for the lubricating system.
2. Ensure normal work of the air distribution mechanism.
3. Ensure normal work of the electric startup system.
4. Ensure normal operation, of front and rear automatic clutches and the drive system.
5. Check whether there is any crack, erosion, spalling or serious stepped wear on each gear tooth of the rear transmission box.
6. In disassembling the engine, the carbon deposit on the cylinder head, piston top, piston ring and exhaust port should be removed. Check the fit clearance between the piston and the cylinder wall, and the smaller head of the crank connecting rod and the piston pin.
7. Ensure normal work of front and rear shock absorbers, the frame and accessory mechanisms.
8. Ensure normal fuel supply for the fuel system.
9. Ensure normal work of instruments and the electric system.
10. In disassembling the whole motorcycle, check whether there is any damaged part for the steering column, front and rear wheels, the carburetor, the air filter, front and rear brakes, the maneuvering system, and the drive system. Clean each part and fill in lubricating grease and lubricating oil. Adjust the fit clearance after reassembly .

Service and Maintenance for the Carburetor

Only when the carburetor is well serviced and maintained can we ensure normal work of the motorcycle and can the need of the engine for inflammable gas mixture be met. Only in this way can we ensure good dynamic property and economy of the engine.

The carburetor should be serviced and maintained in the following aspects:

1. Regularly check the tightness of the carburetor, intake pipe, T-pipe, cylinder head, cylinder block and intake port of the crankcase to ensure good sealing. Otherwise, gas leakage may result in that the motorcycle has no idle speed, or its idle speed is not stable, sometimes high and sometimes low. Since the conditions of the carburetor directly affect the dynamic property and economy of the motorcycle, the carburetor should be regularly cleaned to maintain good performance.

2. In driving, some impurities and dirt may build up on the carburetor. Generally after every 2000 km, the carburetor should be removed for checking and cleaning to eliminate faults of the carburetor. Otherwise, the main measuring orifice, idle measuring orifice and gas mixture screw hole may be blocked, and the normal work of the carburetor may be affected.

3. Check whether there is any hardening, deformation or leakage occurring on the T-pipe and the rubber hose. If any, replace it immediately.

During the course of installation, special attention should be given to the tightness of the connection of the connecting pipe of the carburetor and the cylinder. No gas leakage is allowed. If there is any gas leakage, a film of sealant may be also applied to prevent such leakage.

Check and Replacement of Lubricating Oil

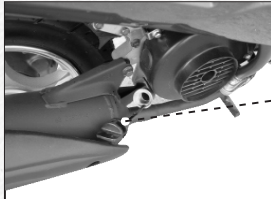

First, twist off the oil gauge and check whether the lubricating oil becomes black or deteriorated.



If the lubricating oil becomes black or deteriorated, remove the drain plug of the engine to drain the lubricating oil and replace it.

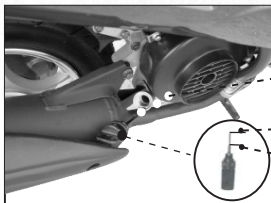

Level the motorcycle and fill in oil until the oil level is between the upper and lower markings.

Upper oil level marking

Lower oil level marking

Caution

- * Replace the lubricating oil when the engine is in the hot state.
- * When the lubricating oil is basically drained off, turn the engine for several times to completely discharge residual lubricating oil.
- * Before filling in new lubricating oil, remove the residual dirt from the crankcase with 0.5L gasoline, and then drain the gasoline.
- * New lubricating oil must be filtered in the replacement of oil.
- * The specification and grade of lubricating oil may be selected from the figure below based on actual local temperature. SF15W/40 gasoline engine oil is recommended.
- * Check whether the filter screen, sealing gasket, spring, O-ring and oil drain plug are in good conditions. If not, replace them.
- * After replacing the lubricating oil, tighten the oil drain plug and oil fill plug, and check whether there is any oil leakage.
- * After replacing the lubricating oil, the idle speed of the engine must be re-adjusted to be within the range of standard values.

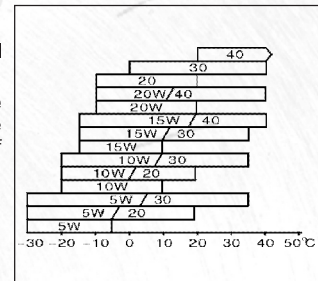

Service and Maintenance of the Spark Plug

Type of spark plug: Connecting screw, flat seating, with nut

Service of the spark plug:

Take off the spark plug. When the color of the insulator skirt of the spark plug is offwhite, it indicates overheat of the engine. Generally, the engine overheat may be caused by the following reasons:

- * The heat value of the spark plug is too small, and it should be replaced with a spark plug with appropriate heat value.
- * The spark plug screws in so much that the insulator excessively extrudes into the combustion chamber. It is necessary to adjust the screwing thickness of the spark plug.
- * The overheat of the engine is caused by the friction of transmission parts of the engine.

Take off the spark plug. If it is found that the color of the insulator of the spark plug is dark black, or there is serious oil stain or dark black carbon deposit on the surface, the main reason for it is that the gaseous inflammable alkene mixture of the carburetor is overrich.

Take off the spark plug. If it is found that the color of the insulator skirt of the spark plug is brown, it indicates that the engine works properly, and there is nothing wrong with the spark plug.

Cleaning the Spark Plug

⚠ Caution

In cleaning the spark plug, make sure not to damage the insulator. It is forbidden to remove the carbon deposit or filth by burning with fire or scrubbing with metal wires.

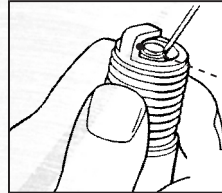

First, soak it with spark plug detergent or gasoline for about half an hour and then use a non-metal blade to remove the carbon deposit surrounding the spark plug, and finally clean the spark plug with gasoline.

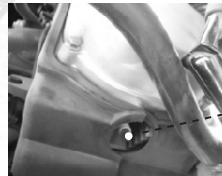

First, mount the sealing washer onto the spark plug, and then tighten the spark plug to place with hands, and finally tighten the spark plug with a socket spanner.

Service and Maintenance for the Air Filter

When the filter element of the air filter is blocked by dust, it may result in increased resistance of the air intake system, overrich gas mixture, reduced power and greater fuel consumption. Therefore, the filter element of the air filter should be cleaned on a regular basis.



Take off the fastening screws of the air filter cover, and remove the air filter cover. Check whether there is too much dust on the sponge foam of the filter element. Take off the sponge foam.

Wipe off the dust inside the air filter with clean and dry cloth.

Clean the foam filter element: Take off the foam filter element. First, soak the foam filter element of the air filter in the detergent, and then pinch and wash it. After the foam filter element is cleaned and dried, soak the foam filter element in SAE lubricating oil until it is saturated. Extrude excessive lubricating oil and mount it.

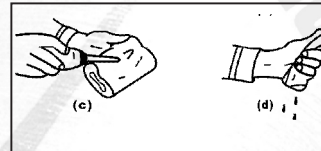
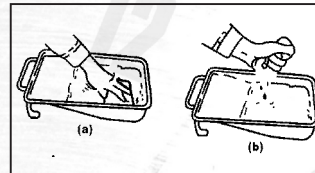

⚠ Caution

- * It is forbidden to use the following cleaning agents to clean paper filter elements, such as gasoline, low ignition-point solvent, acid, alkaline or organic volatile oil.

Adjustment of the accelerator handgrip

Check whether the free travel of the accelerator handgrip is within the specified range, and then adjust it. Please follow the following steps in adjusting the free travel of the accelerator handgrip:

1. First, loosen the locking nut.
2. Then adjust the regulating solenoid.
3. After adjustment, tighten the locking nut.



The accelerator handgrip should work smoothly. The idling clearance of the handgrip should range from 2mm to 6mm.

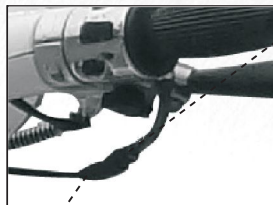

Regulating solenoid

Locking nut

Service and Maintenance for the Front Brake

This model uses the front disc brake, which is featured by secure and reliable braking, labour-saving and good heat dissipation.

Adjustment of the front disc brake

1. First, use the main support to prop up the Motorcycle, and then it is possible to adjust the free travel of the front brake.
2. Adjust the regulating nut of the front brake to adjust the free travel of the front braking handgrip to 10mm~20mm.

Adjust the free travel of the front braking handgrip to 10mm-20mm.

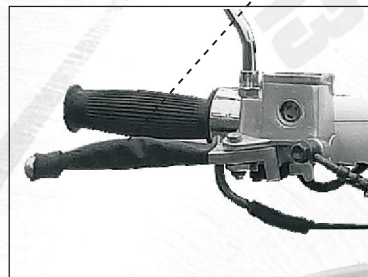



* Check the wear of the front brake. If the travel of the front braking handgrip is too large, it indicates that the wear of the front brake shoe is already beyond the limit.

Disc brake



* Check the wear of the front disc brake. If the surface of friction is abnormal or deformed, please replace it with a new disc brake.

Service and Maintenance for the Rear Brake

Adjustment of the rear disc brake

- * First, use the support to prop up the rear wheel of the motorcycle and then adjust the free travel for the rear brake.
- * Grip the rear braking handgrip for several times, and then loosen it. Rotate the rear wheel assembly to check whether the rear wheel rotates freely.

Use the support to prop up the motorcycle, and adjust the free travel of the rear braking handgrip to 10mm-20mm.



First check the wear of the rear brake shoes. If the travel of the rear braking pedal is too large to be adjusted, it



Adjustment of the rear braking light

- * Since the braking light of the Motorcycle directly relates to the driving safety of the motorcycle, the conditions of the braking light should be checked from time to time.
- * The switch of the braking light is set on the front and rear braking handgrips. When the braking light can not work properly, the braking light switch and the braking light bulb should be checked and replaced.

In checking the front and rear braking lights, the turn signal light housing must be removed before checking and replacing the front and rear braking light switches.



Front braking light switch

Rear braking light switch

Adjustment of the idle speed

When the motorcycle flames out during operation or the idle speed is not stable, the idle speed of the motorcycle should be adjusted in the following steps:

- * Start the motorcycle first, and the idle speed must be adjusted when the engine of the motorcycle is preheated.
- * Adjust the idle speed to the specified value. Rotate the accelerator handgrip to check whether the speed of the engine is stable or whether flameout occurs.
- * If the engine still works improperly, both the idle speed screw and the gas mixture screw can be adjusted until the idle speed becomes stable. If the problem still preserves, please clean the carburetor.

Adjust the idle speed screw and the gas mixture screw here.



Service and Maintenance for Front and Rear Tires

Only when the proper air pressure is used for the tire can we ensure the comfort and stability of the driving of the motorcycle and prolong the service life of the tires and tire casings of the motorcycle.

Tire specification/air pressure	Front wheel	3.5x10	175kpa
	Rear wheel	3.5x10	225kpa



Check the air pressure of the tire and check whether the rim deforms. If any abnormality is found, it should be handled properly.

Removal and Replacement of Front Wheel

- * Use the main support to prop up the motorcycle.
- * Remove the nut of the front wheel shaft, and take off the front wheel shaft. Take off the front wheel.

Caution:

- * After taking off the front wheel, make sure not to grip the front braking handgrip.
- * In remounting, the tightening torque of the nut of the wheel shaft: 50N.m~70N.m.
- * Adjust the front brake, and make several braking tests. After loosening it, check whether the front wheel rotate flexibly.



Front wheel shaft

Removal and Replacement of the Rear Wheel

- * Turn off the ignition lock switch.
- * Use the main support to prop up the motorcycle, and take off the silencer.
- * Take off the nut of the rear wheel shaft, and remove the rear wheel.

Assembly Precautions

- * In reassembly, the torque of the rear wheel shaft nut: 70N.m~90N.m.
- * Re-adjust the free travel of the rear braking handgrip to 10mm~20mm.

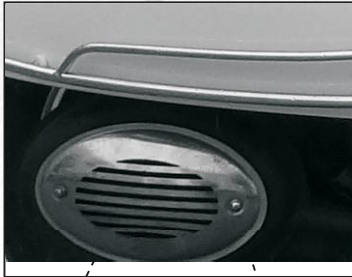

Silencer

Rear wheel shaft
nut

If the tread wear depth in the middle of the tire casing of the motorcycle reaches the following limit, the tire case should be replaced immediately.

Minimum limit of tread depth	Front wheel	2.0mm
	Rear wheel	2.0mm



Check the tread wear depth of the tire casing and whether there is any crack. If any abnormality is founded, the tire casing should be replaced immediately.

⚠ Caution

- * Too low tire pressure will increase the rolling resistance of the tire of the motorcycle and increase fuel consumption. In worse cases, it may cause local delaminating of the tire body and cause tire burst.
- * Too high tire pressure will reduce the comfort of riding and fasten the wear of each part.

Service and Maintenance for the Environmental Protection Device

Motorcycle drivers must conduct correct and regular service and maintenance for the environmental protection device, so as to ensure best performance of the environmental protection device. With proper and regular service and maintenance, we can promptly eliminate faults, prolong the service life of the environmental protection device, reduce the maintenance costs, and actually realize the goal of being environmental-friendly and reducing fuel consumption of the motorcycle.

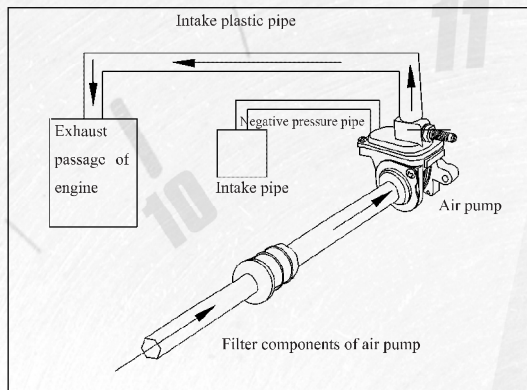

⚠ Caution

The carburetor of the environmental protection device must be serviced and maintained by a professional motorcycle repair shop or the dealer's after-sales service personnel (make sure not to adjust the carburetor without authorization).

- ① Regularly check whether the clamp of the intake negative pressure hose, the clamp of the intake plastic hose, or the fastening bolt of the intake iron pipe is loose. If yes, tighten or replace the clamp.
- ② Regularly check whether there is any aging, air leakage or damage on the intake negative pressure hose and the intake plastic hose. If any, replace the intake negative pressure hose and the intake plastic hose.
- ③ Regularly check the working conditions of the air pump of the environmental protection device. If the air pump is blocked or can not work properly, replace the air pump of the environmental protection device.
- ④ Regularly check the air filter. If any dust or dirt exists on the air filter, the air flow will be reduced, thus changing the concentration of the gas mixture and increasing fuel consumption. Therefore, it must be changed.

Service and Maintenance for the Accumulator Cell

In this model, the accumulator cell is mounted below the seat cushion, DC power supply is used for the electric system of the model. For the first 1000km-3000km of the motorcycle, the accumulator cell should be serviced and maintained as follows:

1. Check whether the accumulator cell can work properly.
2. Check whether the positive and negative electrode connection is loose.
3. When the accumulator cell is not used for a long time, the accumulator cell must be charged once a month.
4. Check whether the electrolyte level of the accumulator cell is between the upper and lower markings. When the level is below the lower marking, add some distilled water.

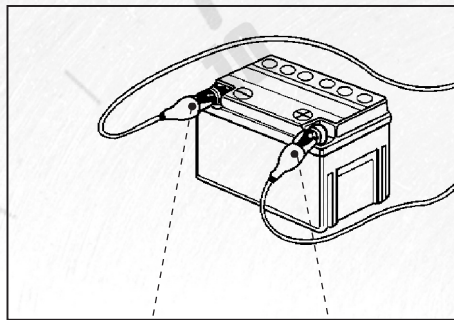

Check whether the connection of the accumulator cell is loose. If it is loose, tighten it.

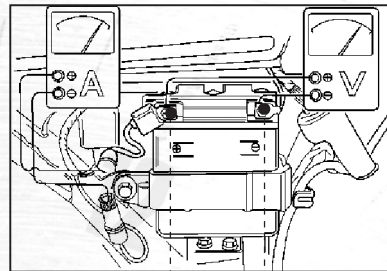

Check whether the voltage of the accumulator cell is within the range of "12V". When the voltage of the accumulator cell is not enough, charge the accumulator cell.

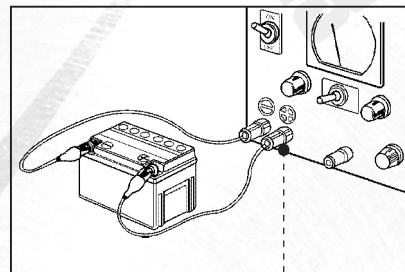

When the accumulator cell of the motorcycle is not used for a long time, it will self-discharge, and the accumulator cell must be charged once a month.

Service and Maintenance for the Fuse

The fuse is connected in series in the charging and discharging of the accumulator cell. When the charging current or the discharging current exceeds the specified value, the fuse will automatically break to protect the accumulator cell and electrical components. For this model, the fusing current of the fuse is 15A.

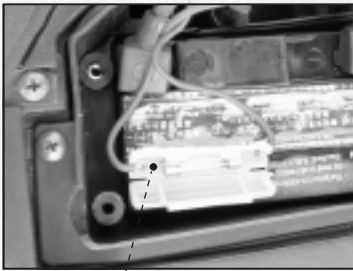

When the electric system of the motorcycle outputs no current, first we should check whether the fuse is broken. If yes, replace the fuse.

⚠ Caution

- * After the fuse burns out, we should first find out the reason causing too large current, and at the same time, replace it with a fuse with appropriate specification.

Service and Maintenance for the Horn

After the motorcycle has run for a certain period of time, the fixing of the horn may be loose, and its housing may collide with other parts, thus affecting the sound of the horn. In this case, the sound volume of the horn should be re-adjusted.



If the horn gives a weaker or no sound, remove the front panel. Use a multi-meter to measure the output voltage of the horn circuit. If the input voltage is normal, use the horn regulating screw to adjust the sound volume of the horn to the normal level.

Storage of the Motorcycle

Long-time storage:

If the motorcycle needs to be parked for a long-time (more than one month), it should be done in the following steps:

- * Drain off all the residual fuel in the fuel tank and in the carburetor. Spray the fuel tank with spray-type antirust oil. Mount the fuel tank cover.
- * Take off the spark plug. Pour 5mL clean lubricating oil into the cylinder. Tread the starting arm for several times to enable the poured-in lubricating oil to be evenly distributed in the combustion chamber. Install the spark plug.
- * Take off the accumulator cell, and store it in a dry, dark and indoor environment. Perform slow charging for the accumulator cell once a month.
- * Wash the motorcycle clean, and wipe if dry with soft cloth. Wax the painted surfaces, and apply a film of anti-rust oil to the chromium-plated surface.
- * Increase the tire pressure to the specified standard value. Place tie plugs below the tires of the motorcycle to lift the wheels above the ground.
- * Well cover the Motorcycle, and park it in a well-ventilated, dry, clean, rainproof and sunproof place, far away from any hazardous substance such as inflammable material or chemical corrosive.

Re-use after Storage

- * Clean the Motorcycle. Replace the engine oil if the motorcycle has been stored for more than 4 months.
- * Check the accumulator cell. If necessary, use it after it is charged.
- * Clean up the antirust oil in the fuel tank, and fill in new fuel /
- * Perform overall checkup necessary to be done before driving.

Service and Maintenance Interval Table

Regular Service and Maintenance is generally based on the reading of the odometer. When the motorcycle is working under bad conditions or under load operation for a long time, the service and maintenance interval should be appropriately shortened.

Times of service and maintenance		Item Interval	Odometer				Remarks
Items of service and maintenance			1000km	2000km	4000km	8500km	
	Fuel system		C	C	C	C	Item ※※ can only be serviced and maintained by designated after-sales service personnel. When driving in an extremely moisture or highly dusty place, the service and maintenance interval should be appropriately shortened.
	Fuel filter		C	C	C	C	
	Controller cable		A	A/C	A/C	A/C	
※※	Carburetor		C	C	C	C	
	Air filter element		C	C	C	C	
	Spark plug gap		A/C	A/C	A/C	A/C	
※※	valve lash		A	A	A	A	
	Lubricating oil of engine		R	R	R	R	
	Lubricating oil filtering screen		C	C	C	C	
※※	Timing chain		I	A	A	A	
	Carburetor idling		A	A	A	A	
※※	Drive belt		-	A	R	R	
	Accumulator cell		B	B	B	B	
	Brake shoe		I	A	A	R	
※※	Braking system		A	A	A	R	
	Braking light switch		A	A	A	A	
	Lighting system		I	I	I	I	
※※	Clutch		I	I	I	I	
※※	Shock absorber		I	I	A	A	
	Nuts and bolts		G	G	G	G	
	Tire casings for front and rear wheels		I	I	I	I	
	Steering handgrip bearings		I	A	A	R	

A-Adjustment C-Cleaning I-Inspection R-Replacement G-Tightening B-Battery Charging

Service and Maintenance Interval Table for Lubricated Parts

Name	Model	Odometer reading								
		Kilometers	1000	2000	4000	8500	10500	15000	20000	
lubricating oil of engine	SAE 15W 10SF	-	R	R	R	R	R	R	R	
Braking pull-rod	OKS-400(Multipurpose lithium-based lubricating grease)	-	-	R	R	R	R	R	R	
Disc brake braking liquid	DOT3 or DOT4	-				R	-			
Lubricating oil for front shock absorber	Lubricating grease for shock absorber	-	I	I	I	T	I	I	I	
Tachometer gear	OKS-400(Multipurpose lithium-based lubricating grease)	-			I	R	I	R	I	
Steering gear	OKS-400(Multipurpose lithium-based lubricating grease)	-				I	-	R	-	
Bearings for front and rear wheels	OKS-400(Multipurpose lithium-based lubricating grease)	-			I	R	I	R	R	
Rear braking swing arm	OKS-400(Multipurpose lithium-based lubricating grease)	-				I	-	I	-	

I-Inspection R-Replacement T-Addition

Table

Fault system	Fault	Causes	Troubleshooting
Fuel system	The engine is difficult or is unable to be started.	Fuel cannot enter the carburetor; The fuel negative pressure switch is blocked; The T-pipe leaks; The fuel pipe is blocked; The vacuum pipe is blocked.	Dredge each blocked place. Clean the fuel negative pressure switch Replace the T-pipe Dredge the fuel pipe. Dredge the vacuum pipe
	The motorcycle is difficult to be started or the fuel is excessively consumed.	The carburetor is blocked; The adjustment of the mixing ratio and concentration of the carburetor is incorrect; The carburetor leaks; The fuel filter is blocked; The throttle of the carburetor is worn; The fuel goes bad; The air vent of the fuel tank is blocked; The fuel in the fuel tank is not enough.	Clean or replace the carburetor Readjust the mixing ratio and concentration of the carburetor. Clean the carburetor or replace the carburetor floater Clean the fuel filter Replace the throttle Replace the fuel. Dredge the air vent of the fuel tank Add fuel to the fuel tank
Air intake/exhaust system	The motorcycle is difficult to be started or is short of power.	The Air filter element is blocked; The air filter leaks; The air filter has too much dust; The air filter housing leaks; Too much carbon is built up at the exhaust port; The exhaust port leaks; The silencer is blocked.	Clean the air filter element Replace the air filter Clean the air filter element. Repair or change the air filter housing. Clean the carbon buildup at the exhaust port. The exhaust port leaks. The silencer is blocked.

Continued

Fault system	Fault	Causes	Troubleshooting
Environmental protection device	Emitted pollutants exceed applicable standards	Too much carbon is built up at the secondary air intake port. The air pump is blocked or damaged. The air pump filter is blocked or damaged. The intake rubber hose is aged or leaks. The clamp is loose or damaged.	Clean the carbon buildup at the secondary air intake port. Replace the air pump. Replace the air pump filter. Replace the intake rubber hose. Replace the clamp.
Ignition system	Weak spark or no spark	There is carbon buildup or dirt on the spark plug. The spark plug gap is improper. The insulation part of the spark plug is damaged, resulting in Short-circuit of electrodes.	Clean the carbon buildup and dirt on the spark plug . Adjust the gap to 0.6mm~0.7mm Replace the spark plug
		Short-circuit of the ignition coil C,D,I igniter is faulty.	Replace the ignition coil Replace C,D,I igniter,
		The impulse generator is faulty. The connection of the ignition system is loose.	Replace the impulse generator. Check each connection.
Air distribution system	The engine is difficult to be started up or the idling is not stable	The sealing washer of the cylinder head leaks. The adjustment of the valve lash is incorrect . The air valve stem bends. Th elasticity of the air valve spring is reduced.	Replace the sealing washer or apply some sealant. Adjust the valve lash to 0.10mm~0.14mm Replace the air valve. Replace the air valve spring.

Continued

Fault system	Fault	Causes	Troubleshooting
Air distribution system	The cylinder pressure is too high.	There is too much carbon buildup in the combustion chamber and on the top of the piston.	Clean the carbon buildup in the combustion chamber and on the top of the piston.
	The engine shows big noise.	The adjustment of the valve lash is improper. The air valve spring breaks off. The cylinder and piston wear out.	Readjust the valve lash Replace the air valve spring. Replace the cylinder and piston.
	The cylinder pressure is too low.	The cylinder, piston and piston ring seriously wear out.	Replace the cylinder, piston and piston ring.
	The silencer gives blue smoke.	The piston ring wears out. The piston ring is improperly mounted. There is scratch or wear on the piston or cylinder wall.	Replace the piston ring. Remount the piston ring. Replace the piston or cylinder.
	The cylinder head leaks.	The air valve stem or air valve guide pipe wears out.	Replace the air valve stem and air valve guide pipe.
Travel system	The front wheel deviates.	The front shock absorber deforms. The front wheel shafts bends. The front wheel deforms. The front wheel is improperly mounted. The front wheel bearings are worn out or damaged.	Replace the front shock absorber Rectify the front wheel shaft. Rectify the front wheel and replace the front wheel Remount it Replace the front wheel bearings.
	The front wheel swings.	The front aluminum wheel deforms. The nut of the front wheel shaft is loose. The tire pressure is too low. The front wheel shaft is loose.	Replace the front aluminum wheel. Tighten the nut of the front wheel shaft. Increase the tire pressure. Tighten the nut of the front wheel shaft.

Continued

Fault system	Fault	Causes	Troubleshooting
Travel system	The rear wheel swings.	The rear aluminum wheel deforms. The tire pressure is too low. The rear wheel shaft is loose.	Replace the rear aluminum wheel. Increase the tire pressure. Tighten the nut of the rear wheel shaft.
Suspension system	The shock absorber is too soft.	The spring of the shock absorber loses elasticity. The shock absorber is improperly adjusted.	Replace the spring of the shock absorber Re-adjust the shock absorber
Braking system	The braking performance is poor.	The brake malfunctions. The brake shoe wears out. The brake disc wears out.	Adjust and repair the braking system Replace the brake shoe Replace the brake disc. Add brake oil.
Lighting system	The head Light is not on.	The head light bulb burns out , The housing assembly switch is faulty. The connecting plug is loose. The fuse burns out. The accumulator cell is faulty.	Replace the head light bulb, Repair the housing assembly switch. Tighten the connecting plug. Replace the fuse. Replace the accumulator cell
		The lighting coil of the magnetor is faulty.	Replace the lighting coil.

50cc

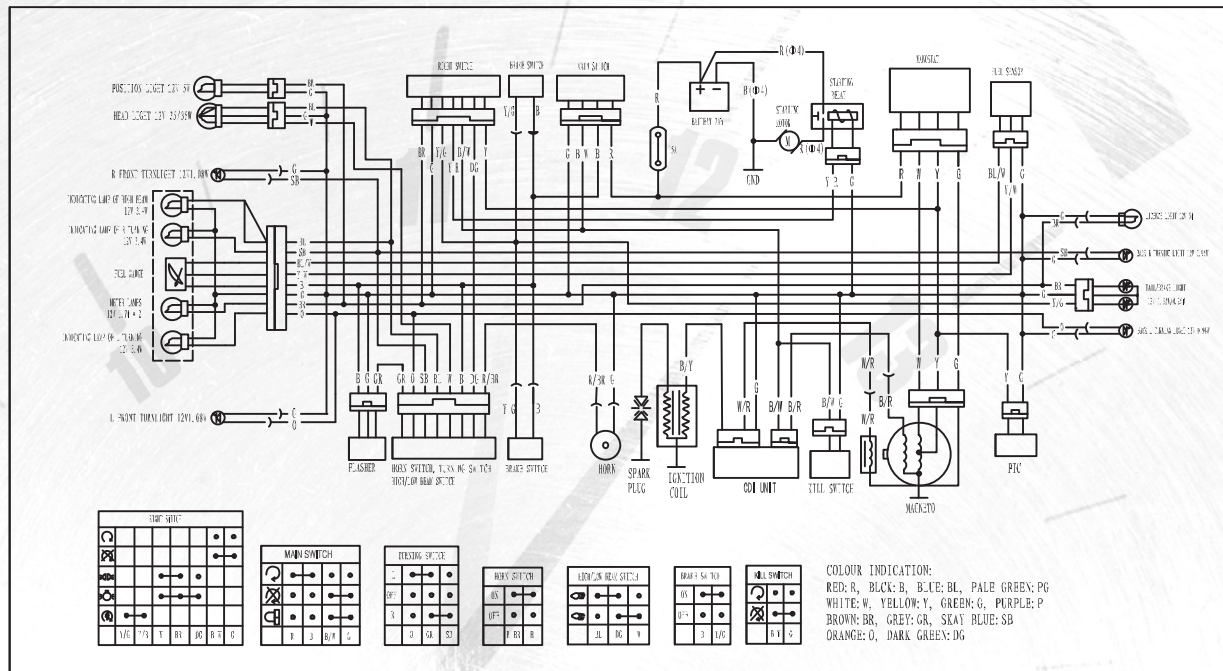

125cc

