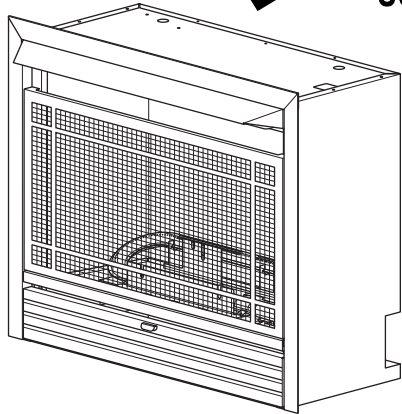


**VENT-FREE GAS FIREPLACE  
INSERT  
OWNER'S OPERATION AND  
INSTALLATION MANUAL**

**MODEL FDF300R  
SKU #170032**



This insert can be used in the mantel and  
fireplace systems CM300-1

**⚠ WARNING:** If the information in this manual is not followed exactly, a fire or explosion may result causing property damage, personal injury or loss of life.

- Do not store or use gasoline or other flammable vapors and liquids in the vicinity of this or any other appliance.
- **WHAT TO DO IF YOU SMELL GAS**
  - Do not try to light any appliance.
  - Do not touch any electrical switch; do not use any phone in your building.
  - Immediately call your gas supplier from a neighbor's phone. Follow the gas supplier's instructions.
  - If you cannot reach your gas supplier, call the fire department.
- Installation and service must be performed by a qualified installer, service agency or the gas supplier.

**⚠ WARNING:** This appliance is equipped for Natural and Propane gas. Field conversion is not permitted other than between natural or propane gases.



**Questions, problems, missing parts?** Before returning to your retailer, call our customer service department at 1-855-607-6557, 8:00 am - 4:30 pm EST, Monday through Friday or email [contact@factorybuysdirect.com](mailto:contact@factorybuysdirect.com)

---

---

## TABLE OF CONTENTS

---


---

Safety .....	3	Operation.....	19
Specifications .....	4	Inspecting Burners.....	23
Qualified Installing Agency .....	5	Care And Maintenance.....	24
Product Features .....	5	Electrical .....	26
Local Codes.....	5	Troubleshooting.....	28
Unpacking.....	5	Service Hints .....	31
Air For Combustion and Ventilation.....	6	Technical Service.....	31
Product Identification.....	6	Parts .....	32
Water Vapor: A By-Product Of		Replacement Parts .....	34
Unvented Room Heaters.....	6	Accessories .....	35
Installation .....	8	Warranty .....	36

### SAVE THIS BOOK

**INSTALLER:** Leave this manual with the appliance.  
**CONSUMER:** Retain this manual for future reference.

**This is an unvented gas-fired heater. It uses air (oxygen) from the room in which it is installed. Provisions for adequate combustion and ventilation air must be provided. Refer to *Air For Combustion and Ventilation* section on page 6 of this manual.**

** WARNING:** Improper installation, adjustment, alteration, service or maintenance can cause injury or property damage. Refer to this manual for correct installation and operational procedures. For assistance or additional information consult a qualified installer, service agency or the gas supplier.

**This appliance may be installed in an aftermarket,\* permanently located, manufactured (mobile) home, where not prohibited by local codes.**

**This appliance is only for use with propane or natural gas. Field conversion by any other means including the use of a kit is not permitted.**

\* Aftermarket: Completion of sale, not for purpose of resale, from the manufacturer.

### PATENT INFORMATION

This product may be covered by one or more of the following United States patents:  
8,915,239 8,851,065 8,764,436 8,757,202 8,757,139 8,752,541 8,568,136  
8,545,216 8,517,718 8,516,878 8,506,290 8,465,277 8,317,511 8,297,968  
8,281,781 8,241,034 8,235,708 8,152,515 8,011,920 7,967,006 7,967,007  
7,654,820 7,730,765 7,677,236 7,607,426 7,434,447

## SAFETY

**IMPORTANT:** Read this owner's manual carefully and completely before trying to assemble, operate, or service this heater. Improper use of this heater can cause serious injury or death from burns, fire, explosion, electrical shock and carbon monoxide poisoning. Failure to follow these instructions will void the warranty.

Only a qualified installer, service agent, or local gas supplier may install and service this product.

**⚠ WARNING:** Keep the appliance area clear and free from combustible materials, gasoline, and other flammable vapors and liquids.

**⚠ WARNING:** This appliance can be used with propane or natural gas. It is shipped from the factory adjusted for use with propane.

**⚠ DANGER:** Carbon monoxide poisoning may lead to death!

**CARBON MONOXIDE POISONING:** Early signs of carbon monoxide poisoning resemble the flu, with headaches, dizziness or nausea. If you have these signs, the heater may not be working properly. Get fresh air at once! Have heater serviced. Some people are more affected by carbon monoxide than others. These include pregnant women, people with heart or lung disease or anemia, those under the influence of alcohol and those at high altitudes.

**NATURAL AND PROPANE GAS:** Natural and Propane gas are odorless. An odor-making agent is added to the gas. The odor helps you detect a gas leak. However, the odor added to the gas can fade. Gas may be present even though no odor exists.

**⚠ WARNING:** Any change to this heater or its controls can be dangerous.

**⚠ WARNING:** Do not allow fans to blow directly into fireplace. Avoid any drafts that alter burner flame patterns.

**⚠ WARNING:** Do not use a blower insert, heat exchange insert or other accessory not approved for use with this heater.

**⚠ WARNING:** Due to high temperatures, the appliance should be located out of traffic and away from furniture and draperies.

**⚠ WARNING:** Do not place clothing or other flammable material on or near the appliance. Never place any objects in the heater.

**⚠ WARNING:** Heater becomes very hot when running. Keep children and adults away from hot surfaces to avoid burns or clothing ignition. Fireplace will remain hot for a time after shut-down. Allow surfaces to cool before touching.

**⚠ WARNING:** Carefully supervise young children when they are in the room with the heater.

**⚠ WARNING:** You must operate this heater with screen in place.

## SAFETY

1. Do not place Propane supply tank(s) inside any structure. Propane supply tank(s) must be placed outdoors.
2. This heater shall not be installed in a bedroom or bathroom.
3. This heater needs fresh air ventilation to run properly. This heater has an Oxygen Depletion Sensing (ODS) safety shutoff system. The ODS shuts down the heater if not enough fresh air is available. See *Air for Combustion and Ventilation*, pages 6 and 7. If heater keeps shutting off, see *Troubleshooting*, page 28.
4. Keep all air openings in front and bottom of heater clear and free of debris. This will ensure enough air for proper combustion.
5. If heater shuts off, do not relight until you have provided fresh, outside air. If heater keeps shutting off, have it serviced.
6. Do not run heater:
  - Where flammable liquids or vapors are used or stored.
  - Under dusty conditions.
7. Before using furniture polish, wax, carpet cleaner, or similar products, turn heater off. If heated, the vapors from these products may create a white powder residue within burner box or on adjacent walls or furniture.
8. Always run heater with control knob at PILOT or ON locked positions. Never set control knob between locked positions. Poor combustion and higher levels of carbon monoxide may result.
9. Do not use heater if any part has been under water. Immediately call a qualified service technician to inspect the room heater and to replace any part of the control system and any gas control which has been under water.
10. Turn off and unplug heater and let cool before servicing. Only a qualified service person should service and repair heater.
11. Operating heater above elevations of 4,500 feet could cause pilot outage.
12. To prevent performance problems, do not use propane fuel tank of less than 100 lbs. capacity.
13. Do not use this heater as a wood-burning heater. Use only the logs provided with the heater.
14. To prevent sooting, follow the instructions in *Care and Maintenance* (see page 24).
15. Do not add extra logs or ornaments such as pine cones, vermiculite, or rock wool. Using these added items can cause sooting. Do not add lava rock around base. Rock and debris could fall into the control area of heater. After servicing, always replace screen before operating heater.
16. This heater is designed to be smokeless. If logs ever appear to smoke, turn off heater and call a qualified service person.

*Note: During initial operation, slight smoking could occur due to log curing and the heater burning manufacturing residues.*

## SPECIFICATIONS

Model FDF300R		
Gas Type	Natural Gas	Propane Gas
Ignition	Piezo Ignitor	Piezo Ignitor
Input Rating	26,000 Btu/Hr	26,000 Btu/Hr
Pressure Regulator Setting	4" W.C.	9.5" W.C.
Inlet Gas Pressure* (inches of water) (*for purposes of input adjustment)	Maximum 9" Minimum 5"	Maximum 14" Minimum 11"
Heater Dimensions (WxHxD) • 29.1" × 23.9" × 13.9"		
Carton Dimensions (WxHxD) • 30.9" × 26.9" × 14.8"		
Stove Weight • 47.6 lbs		
Shipping Weight • 55.7 lbs		

---

---

## QUALIFIED INSTALLING AGENCY

---

---

Only a qualified agency should install and replace gas piping, gas utilization equipment or accessories, and repair and equipment servicing. The term "qualified agency" means any individual, firm, corporation, or company that either in person or through a representative is engaged in and is responsible for:

- a) Installing, testing, or replacing gas piping or
- b) Connecting, installing, testing, repairing, or servicing equipment; that is experienced in such work; that is familiar with all precautions required; and that has complied with all the requirement of the authority having jurisdiction.

---

---

## PRODUCT FEATURES

---

---

### SAFETY PILOT

This heater has a pilot with an Oxygen Depletion Sensing (ODS) safety shutoff system. The ODS/pilot shuts off the heater if there is not enough fresh air.

### PIEZO IGNITION SYSTEM

This heater is equipped with an electronic piezo control system. This system requires one AAA battery (provided).

### THERMOSTATIC CONTROL

The control automatically cycles the burner on and off to maintain a desired room temperature.

### 2 GAS OPTIONS AVAILABLE

Your heater is equipped to operate on either Propane or Natural gas. The heater is shipped from the factory ready for connecting to Propane. The heater can easily be changed to Natural gas by having your qualified installer follow the instructions on page 10 and the markings on the heater.

---

---

## LOCAL CODES

---

---

Install and use heater with care. Follow all local codes. In the absence of local codes, use the latest edition of *The National Fuel Gas Code, ANSI Z223.1/NFPA 54\**.

\*Available from:

American National Standards Institute, Inc.  
1430 Broadway  
New York, NY 10018  
National Fire Protection Association, Inc.  
1 Batterymarch Park  
Quincy, MA 02269-9101

This heater is designed for vent-free operation. State and local codes in some areas prohibit the use of vent-free heaters.

**State of Massachusetts:** The installation must be made by a licensed plumber or gas fitter in the Commonwealth of Massachusetts.

Sellers of unvented propane or natural gas-fired supplemental room heaters shall provide to each purchaser a copy of 527 CMR 30 upon sale of the unit.

In the State of Massachusetts the gas cock must be a T-handle type. The State of Massachusetts requires that a flexible appliance connector cannot exceed three feet in length.

---

---

## UNPACKING

---

---

1. Remove top inner pack.
2. Tilt carton so that heater is upright.
3. Remove protective side packaging.
4. Slide heater out of carton.
5. Remove protective plastic wrap.
6. Hold the screen, lift, and pull forward.
7. Remove log set by cutting plastic ties.
8. Carefully unwrap log.
9. Check for any shipping damage. If heater or log is damaged, promptly inform your dealer where you bought the heater.
10. Remove four screws and two bottoms of angle iron.

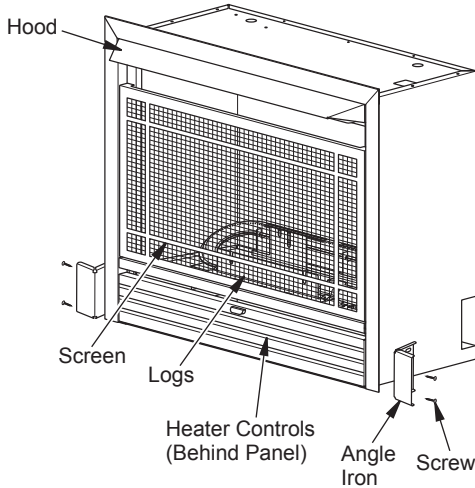
---

---

## PRODUCT IDENTIFICATION

---

---



*Figure 1 - Vent-Free Fireplace Insert*

---

---

## WATER VAPOR: A BY-PRODUCT OF UNVENTED ROOM HEATERS

---

---

Water vapor is a by-product of gas combustion. An unvented room heater produces approximately one (1) ounce (30 mL) of water for every 1,000 BTUs (0.3 KWs) of gas input per hour. Unvented room heaters are recommended as supplemental heat (a room) rather than a primary heat source (an entire house). In most supplemental heat applications, the water vapor does not create a problem. In most applications, the water vapor enhances the low humidity atmosphere experienced during cold weather.

The following steps will help ensure that water vapor does not become a problem.

1. Be sure the heater is sized properly for the application, including ample combustion air and circulation air.
2. If high humidity is experienced, a dehumidifier may be used to help lower the water vapor content of the air.
3. Do not use an unvented room heater as the primary heat source.

---

---

## AIR FOR COMBUSTION AND VENTILATION

---

---

**⚠ WARNING:** This heater shall not be installed in a confined space or unusually tight construction unless provisions are provided for adequate combustion and ventilation air. Read the following instructions to insure proper fresh air for this and other fuel-burning appliances in your home.

Today's homes are built more energy efficient than ever. New materials, increased insulation and new construction methods help reduce heat loss in homes. Home owners weather strip and caulk around windows and doors to keep the cold air out and the warm air in. During heating months, home owners want their homes as airtight as possible.

While it is good to make your home energy efficient, your home needs to breathe. Fresh air must enter your home. All fuel-burning appliances need fresh air for proper combustion and ventilation.

## AIR FOR COMBUSTION AND VENTILATION

Exhaust fans, fireplaces, clothes dryers and fuel burning appliances draw air from the house to operate. You must provide adequate fresh air for these appliances. This will insure proper venting of vented fuel-burning appliances.

**⚠ WARNING:** This heater shall not be installed in a room or space unless the required volume of indoor combustion air is provided by the method described in the *National Fuel Gas Code, ANSI Z223.1/NFPA 54*, the *International Fuel Gas Code*, or applicable local codes.

**⚠ WARNING:** If the area in which the heater may be operated does not meet the required volume for indoor combustion air, combustion and ventilation air shall be provided by one of the methods described in the *National Fuel Gas Code, ANSI Z223.1/NFPA 54*, the *International Fuel Gas Code*, or applicable local codes.

### VENTILATION AIR

#### Ventilation Air From Inside Building

This fresh air would come from an adjoining unconfined space. When ventilating to an adjoining unconfined space, you must provide two permanent openings: one within 12" of the ceiling and one within 12" of the floor on the wall connecting the two spaces (see options 1 and 2, Figure 2). You can also remove door into adjoining room (see option 3, Figure 2). Follow the *National Fuel Gas Code, ANSI Z223.1/NFPA 54, Air for Combustion and Ventilation* for required size of ventilation grills or ducts.

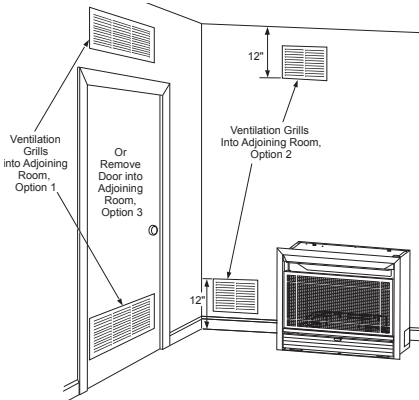


Figure 2 - Ventilation Air from Inside Building

#### Ventilation Air From Outdoors

Provide extra fresh air by using ventilation grills or ducts. You must provide two permanent openings: one within 12" of the ceiling and one within 12" of the floor. Connect these items directly to the outdoors or spaces open to the outdoors. These spaces include attics and crawl spaces. Follow the *National Fuel Gas Code, ANSI Z223.1/NFPA 54, Air for Combustion and Ventilation* for required size of ventilation grills or ducts.

**IMPORTANT:** Do not provide openings for inlet or outlet air into attic if attic has a thermostat-controlled power vent. Heated air entering the attic will activate the power vent. Rework worksheet, adding the space of the adjoining unconfined space. The combined spaces must have enough fresh air to supply all appliances in both spaces.

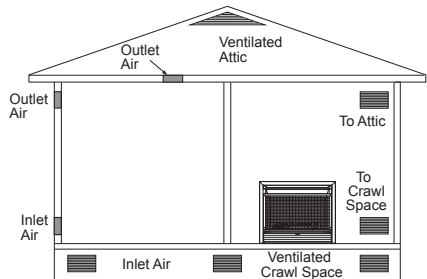


Figure 3 - Ventilation Air from Outdoors

---

---

## INSTALLATION

---

---

**NOTICE:** This heater is intended for use as supplemental heat. Use this heater along with your primary heating system. Do not install this heater as your primary heat source. If you have a central heating system, you may run system's circulating blower while using heater. This will help circulate the heat throughout the house. In the event of a power outage, you can use this heater as your primary heat source.

**⚠ WARNING:** A qualified service person must install heater. Follow all local codes.

**⚠ WARNING:** Never install the heater

- in a bedroom or bathroom
- in a recreational vehicle
- where curtains, furniture, clothing, or other flammable objects are less than 36" from the front, top, or sides of the heater
- in high traffic areas
- in windy or drafty areas

**⚠ CAUTION:** This heater creates warm air currents. These currents move heat to wall surfaces next to heater. Installing heater next to vinyl or cloth wall coverings or operating heater where impurities (such as tobacco smoke, aromatic candles, cleaning fluids, oil or kerosene lamps, etc.) in the air exist, may cause walls to discolor.

*IMPORTANT:* Vent-free heaters add moisture to the air. Although this is beneficial, installing heater in rooms without enough ventilation air may cause mildew to form too much moisture. See [\*Air for Combustion and Ventilation\*](#), pages 6 and 7.

### **CHECK GAS TYPE**

Be sure your gas supply is right for your heater. Otherwise, call dealer where you bought the heater for proper type heater.



## INSTALLATION

### CONNECTING ELECTRICAL SUPPLY

This fireplace insert requires a 120V electrical outlet within 4 feet of the unit. There is a power supply for the remote receiver located in the bottom of the fireplace insert. Extensions cords may be used.

The remote receiver requires 4 AA batteries. This powers the stove in case of an electrical power outage.

1. Locate 6V DC adapter.
2. Plug connector end of adapter into the power change assembly on the back of the fireplace insert.
3. Plug adapter into a 120V electrical outlet.

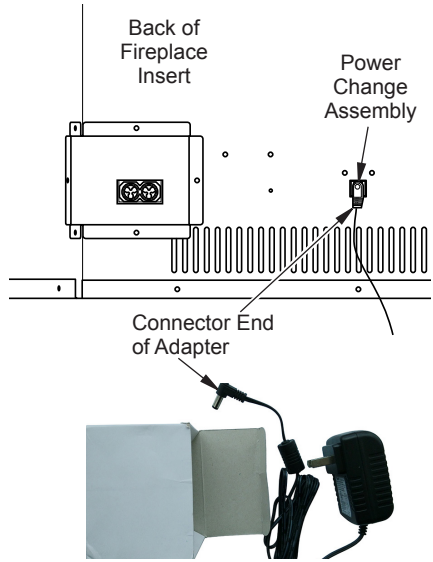


Figure 4 - Connecting to Power Supply

### CLEARANCES TO COMBUSTIBLES

**WARNING:** You must maintain the minimum clearances shown in Figure 5. If you can, provide greater clearances from floor, ceiling, and joining wall. Measure from outermost point of heater.

#### Minimum Wall and Ceiling Clearances

- A. Clearances from outermost point of heater to any combustible side wall should not be less than 6".
- B. Clearances from the heater to the ceiling should not be less than 36".

*Note: When heater is installed directly on carpeting, tile or other combustible material, other than wood flooring, the heater must be installed on a metal or wood panel extending the full width and depth of the heater.*

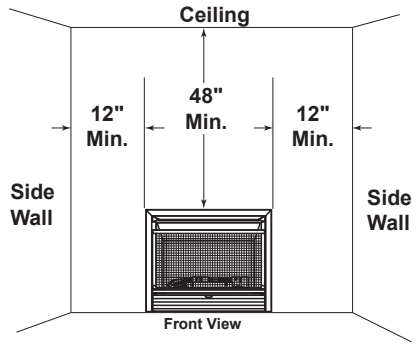


Figure 5 - Minimum Clearances to Wall and Ceiling

# INSTALLATION

## GAS SELECTION

**This appliance is factory preset for propane gas. No changes are required for connecting to propane. Only a qualified installer or service technician can perform gas selection and connecting to gas supply.**

**⚠ CAUTION:** Two gas line installations at the same time are prohibited.

**⚠ CAUTION:** To avoid gas leakage for the gas not being used at the inlet of regulator, a qualified installer or service technician must use supplied cap.

You will notice a color coded plunger on the inside of the regulator. This is normal. When the inlet connection fitting is inserted and tightened, this plunger will be pushed back by the fitting making all of the adjustments for the gas being supplied. **DO NOT REMOVE THE PLUNGER.** The regulator will not work and the warranty will be voided.

The inlet regulator is color coded for identification of the correct gas type. Blue is for propane (LP gas) and yellow is for natural gas.

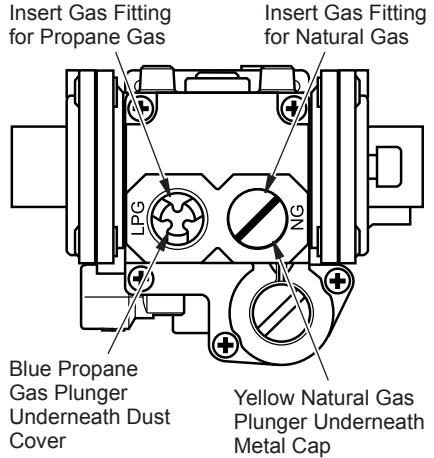
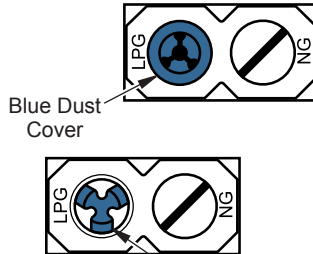


Figure 6 - Gas Regulator

### FOR PROPANE GAS INSTALLATION: BLUE

1. Remove blue dust cover.



**DO NOT REMOVE**  
Blue Propane Plunger  
Install Gas Fitting Here

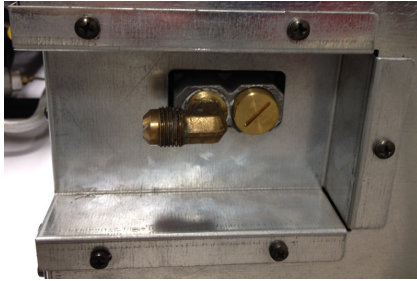
## INSTALLATION

- Apply thread sealant to the threads on the connection fitting. While pushing in, rotate the fitting clockwise until the threads engage the regulator. After the fitting has been hand tightened into the regulator use a wrench to complete tightening of the fitting. Install additional fitting to connect to the house supply.



**Use only the cap supplied on the regulator. Do not use an off the shelf pipe plug. This can damage the plunger. The supplied regulator cap is designed so it will not engage the unused gas type.**

- Apply thread sealant to the threads on the connection fitting. While pushing in, rotate the fitting clockwise until the threads engage the regulator. After the fitting has been hand tightened into the regulator use a wrench to complete tightening of the fitting. Install additional fitting to connect to the house supply.

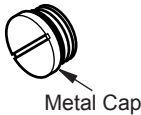
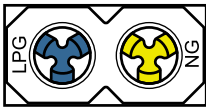


**Use only the metal cap. DO NOT use an off the shelf 3/8" NPT pipe plug. This will damage the plungers located inside the regulator.**

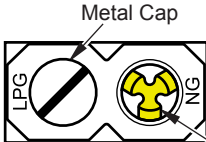
**DO NOT TRY TO REMOVE THE PLUNGERS FROM INSIDE THE REGULATOR. THE PLUNGER WILL BE PUSHED BACK AS THE FITTING IS INSTALLED. REMOVING THE PLUNGERS WILL VOID THE WARRANTY.**

### FOR NATURAL GAS (NG) INSTALLATION: YELLOW

- Remove the blue dust cover from the regulator.
- Remove the metal cap installed over the NG regulator inlet.



- Install metal cap over Propane regulator inlet. This will keep debris out of regulator.



**DO NOT REMOVE**  
Yellow Natural Gas Plunger  
Install Gas Fitting Here

**Make sure the type of gas being used is correct. Check to make sure the connection fitting is in the correct inlet on the regulator. Refer to Connecting to Gas Supply, page 14.**

**If you are using natural gas and the pilot will not light, see Troubleshooting, page 28.**

# INSTALLATION

## BUILT-IN FIREPLACE INSTALLATION

**⚠ WARNING:** Do not allow any combustible materials to overlap the firebox front.

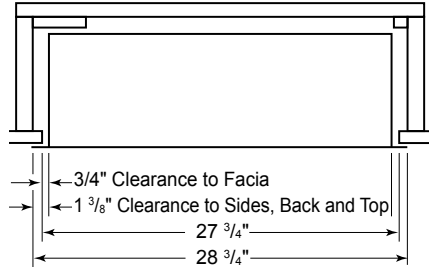
**⚠ WARNING:** Do not allow combustible or noncombustible materials to cover any necessary openings like louvered slots.

**⚠ WARNING:** Never modify or cover the louvered slots on the front of the firebox.

Built-in installation of this fireplace involves installing fireplace into a framed-in enclosure. This makes the front of the fireplace flush with wall. If installing a built-in mantel above the fireplace, you must follow the clearances shown in Figure 7.

**NOTICE:** Surface temperatures of adjacent walls and mantels become hot during operation. Walls and mantels above the fireplace may become hot to the touch. If installed properly, these temperatures meet the requirement of the national product standard. Follow all minimum clearances shown in this manual (see Figure 8).

1. Frame in rough opening. Use dimensions shown in Figure 9 for the rough opening. If installing in a corner, use dimensions shown in Figure 10 (page 13) for the rough opening. The height is 26 1/2", which is the same as the wall opening above.
2. Carefully set fireplace in front of rough opening with back of fireplace inside wall opening.



Note: Height of fireplace opening on fascia to be 23 1/4"

Figure 7 - Clearance to Combustibles

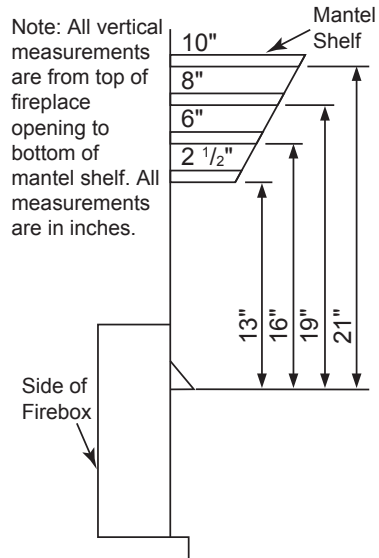


Figure 8 - Fireplace Clearances

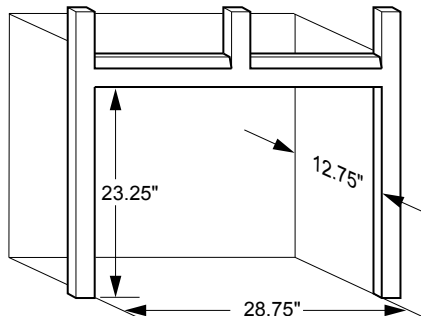
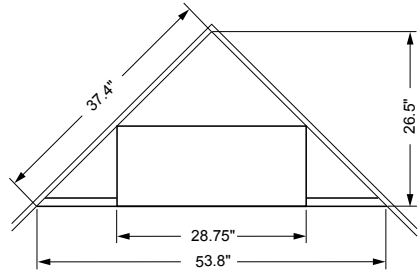


Figure 9 - Rough Opening for Wall Installation

## INSTALLATION

3. Attach gas line to fireplace gas regulator. See *Connecting to Gas Supply*, page 14.
4. Check all gas connections for leaks. See *Checking Gas Connections*, page 16.

**IMPORTANT:** When finishing your firebox, combustible materials such as wall board, gypsum board, sheet rock, drywall, plywood, etc, must have 1/2" clearance to the sides and top of the firebox. Combustible materials should never overlap the firebox front.

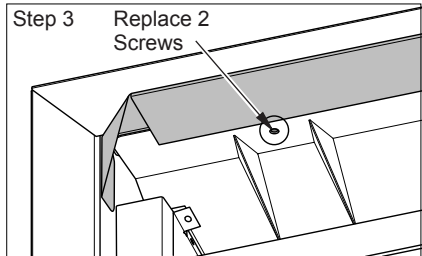
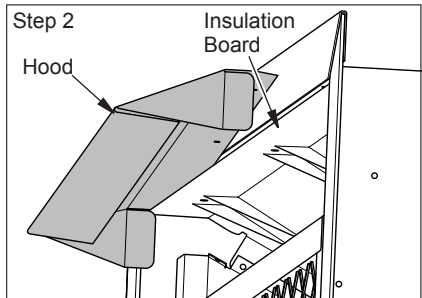
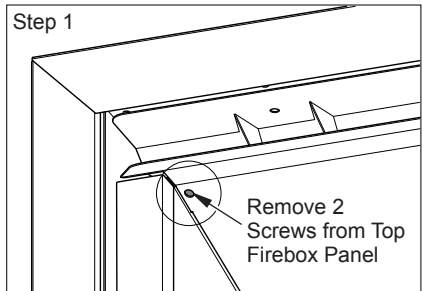


**Figure 10 - Rough Opening for Corner Installation**

## ASSEMBLING HOOD

**CAUTION:** Do not operate fireplace without hood in place.

1. Fireplace hood is positioned on top of shipping inner pack.
2. Remove top of firebox by removing 2 screws located on each end (see Figure 11).
3. Insert the hood along the upper side of the heat insulation board (see Figure 11). Attach hood with 3 screws.
4. Reattach firebox top by reinserting the 2 screws from step 2.



**Figure 11 - Hood Installation**

---

---

## INSTALLATION

---

---

### CONNECTING TO GAS SUPPLY

**⚠ WARNING:** A qualified service technician must connect heater to gas supply. Follow all local codes.

**⚠ WARNING:** This appliance requires a 3/8" NPT (National Pipe Thread) inlet connection to the pressure regulator.

**⚠ WARNING:** For natural gas, Never connect heater to private (non-utility) gas wells. This gas is commonly known as wellhead gas.

**⚠ WARNING:** Do not over-tighten gas connections.

**⚠ CAUTION:** Use only new, black iron or steel pipe. Internally tinned copper tubing may be used in certain areas. Check your local codes. Use pipe of 1/2" diameter or greater to allow proper gas volume to heater. If pipe is too small, undue loss of pressure will occur.

**⚠ CAUTION:** For natural gas, check your gas line pressure before connecting heater to gas line. Gas line pressure must be no greater than 9" of water. If gas line pressure is higher, heater regulator damage could occur.

**⚠ CAUTION:** For propane gas, never connect heater directly to the gas supply. This heater requires an external regulator (not supplied). Install the external regulator between the heater and gas supply.

**⚠ CAUTION:** Avoid damage to regulator. Hold gas regulator with wrench when connecting into gas piping and/or fittings.

**⚠ CAUTION:** Use pipe joint sealant that is resistant to gas (Propane or Natural Gas).

Before installing heater, make sure you have the items listed below:

- external regulator for propane unit only (supplied by installer)
- piping (check local codes)
- sealant (resistant to natural gas and propane gas)
- equipment shutoff valve\*
- test gauge connection\*
- sediment trap
- tee joint
- pipe wrench
- flexible gas hose (check local codes)

\* A CSA design-certified equipment shutoff valve with 1/8" NPT tap is an acceptable alternative to test gauge connection. Purchase the optional CSA design certified equipment shutoff valve from your dealer.

#### Typical Inlet Pipe Diameters

Use 3/8" black iron pipe or greater. Installation must include an equipment shutoff valve, union, and plugged 1/8" NPT tap. Locate NPT tap within reach for test gauge hook up. NPT tap must be upstream from heater (see Figure 12, page 15).

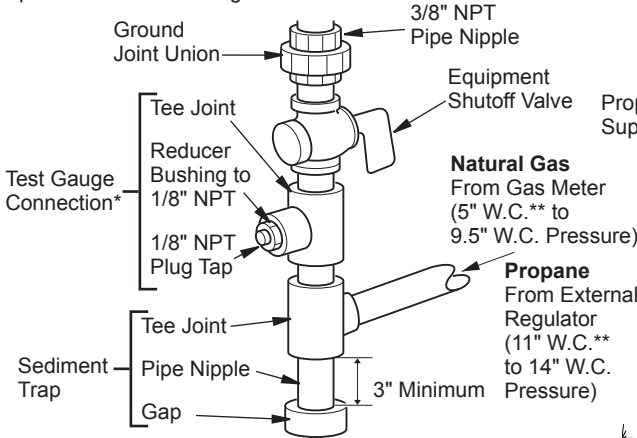
*IMPORTANT: Install an equipment shutoff valve in an accessible location. The equipment shutoff valve is for turning on or shutting off the gas to the appliance.*

For propane installations, apply pipe joint sealant lightly to male threads. This will prevent excess sealant from going into pipe. Excess sealant in pipe could result in clogged heater valves.

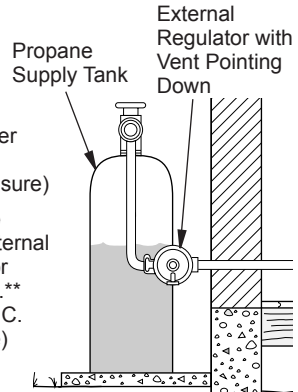
## INSTALLATION

The installer must supply an external regulator. The external regulator will reduce incoming gas pressure. You must reduce incoming gas pressure to between 11" and 14" of water. If you do not reduce incoming gas pressure, heater regulator damage could occur. Install external regulator with the vent pointing down as shown in Figure 13. Pointing the vent down protects it from freezing rain or sleet.

Install sediment trap in supply line as shown in Figure 12. Place sediment trap where it is within reach for cleaning. Place sediment trap where trapped matter is not likely to freeze. A sediment trap traps moisture and contaminants. This keeps them from going into heater controls. If sediment trap is not installed or is installed wrong, heater may not run properly.

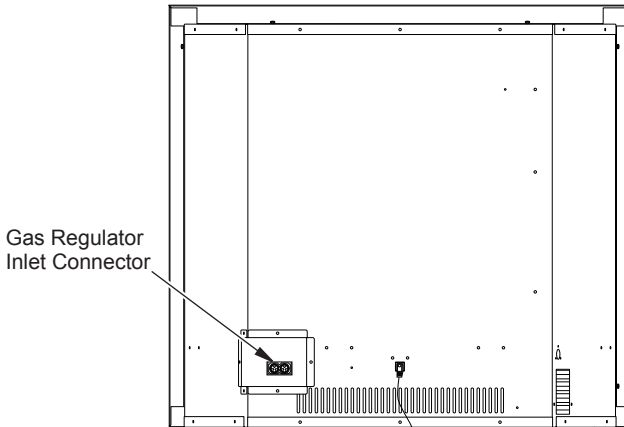


**Figure 12 - Gas Connection**



**Figure 13 - External Regulator with Vent Pointing Down**

\* Purchase the optional CSA design-certified equipment shutoff valve from your dealer.



**Figure 14 - Gas Regulator Location and Gas Line Access into Stove Cabinet**

# INSTALLATION

## CHECKING GAS CONNECTIONS

**⚠ WARNING: Test all gas piping and connections for leaks after installing or servicing. Correct all leaks at once.**

**⚠ WARNING: Never use an open flame to check for a leak. Apply a noncorrosive leak detection fluid to all joints. If bubbles form, there is a leak. Correct all leaks at once.**

### PRESSURE TESTING GAS SUPPLY PIPING SYSTEM

#### Test Pressures In Excess Of 1/2 PSIG (3.5 kPa)

1. Disconnect heater with its appliance main gas valve (control valve) and equipment shutoff valve from gas supply piping system. Pressures in excess of 1/2 PSIG will damage heater regulator.
2. Cap off open end of gas pipe where equipment shutoff valve was connected.
3. Pressurize supply piping system by either opening propane supply tank valve for propane gas or opening main gas valve located on or near gas meter for natural gas or using compressed air.
4. Check all joints of gas supply piping system. Apply noncorrosive leak detection fluid to all joints. If bubbles form, there may be a leak.
5. Correct all leaks at once.
6. Reconnect heater and equipment shutoff valve to gas supply. Check reconnected fittings for leaks.

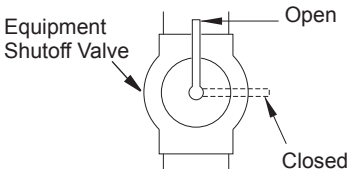


Figure 15 - Equipment Shutoff Valve

#### Test Pressures Equal To or Less Than 1/2 PSIG (3.5 kPa)

1. Close equipment shutoff valve (see Figure 15).
2. Pressurize supply piping system by either opening propane supply tank valve for propane gas or opening main gas valve located on or near gas meter for natural gas or using compressed air.
3. Check all joints from gas meter to equipment shutoff valve for natural gas or propane supply to equipment shutoff valve for propane (see Figure 16 or 17). Apply a noncorrosive leak detection fluid to all joints. Bubbles forming show a leak.
4. Correct all leaks at once.

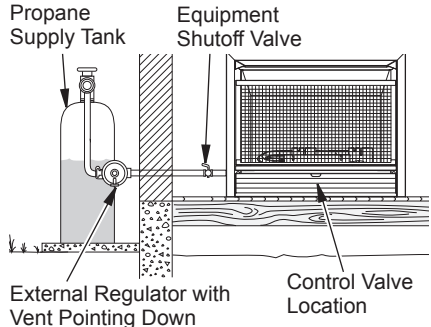


Figure 16 - Checking Gas Joints for Propane Gas

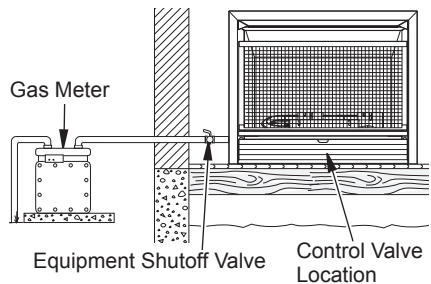


Figure 17 - Checking Gas Joints for Natural Gas

### PRESSURE TESTING HEATER GAS CONNECTIONS

1. Open equipment shutoff valve (see Figure 15).
2. Open main gas valve located on or near gas meter for natural gas or open propane supply tank valve.
3. Make sure control knob of heater is in the OFF position.



## INSTALLATION

4. Check all joints from equipment shutoff valve to control valve (see Figure 16 or 17, page 16). Apply a noncorrosive leak detection fluid to all joints. Bubbles forming show a leak.
5. Correct all leaks at once.
6. Light heater (see *Lighting Instructions* on page 19). Check all other internal joints for leaks.
7. Turn off heater (see *To Turn Off Gas Appliance*, page 20).

### INSTALLING LOGS

**⚠ WARNING:** Failure to position the parts in accordance with these diagrams or failure to use only parts specifically approved with this heater may result in property damage or personal injury.

**⚠ CAUTION:** After installation, and periodically thereafter, check to ensure that no flame comes in contact with any log. With the heater set to high, check to see if flames contact any log. If so, reposition logs according to the log installation instructions in this manual. Flames contacting logs will create soot.

1. Install log 1 onto the two slots in the middle plate (see Figure 18).
2. Install log 2 onto the two slots in the left plate (see Figure 18).
3. Install log 3 onto the two slots in the right plate (see Figure 18).
4. Install the recessed hole on the bottom of log 4 onto the pin on log 1 and place onto log 3 (see Figure 19).
5. Install the recessed hole on the bottom of log 5 onto the pin on log 1 and place onto log 2 (see Figure 19).

**IMPORTANT:** Make sure logs do not cover any burner ports (see Figure 19). It is very important to install the logs exactly as instructed. Do not modify logs. Use only logs supplied with heater.

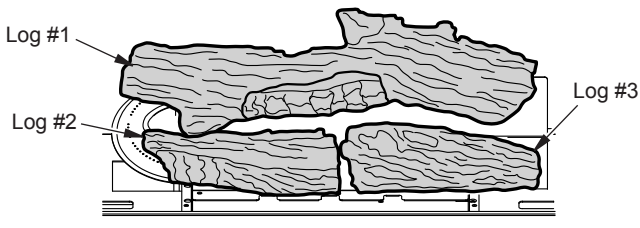


Figure 18 - Installing Logs 1, 2 and 3

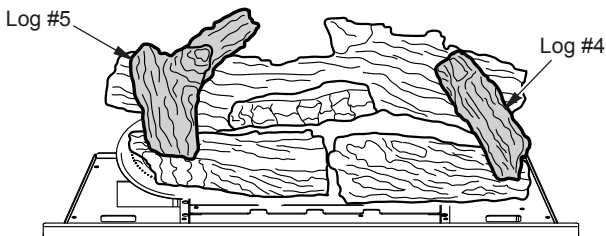


Figure 19 - Installing Logs 4 and 5

# INSTALLATION

## INSTALLING BATTERIES

**⚠ CAUTION: Do not mix old and new batteries. Do not mix alkaline, standard (carbon - zinc), or rechargeable (nickel - cadmium) batteries. Do not dispose of batteries in fire, batteries may explode or leak.**

- Batteries are included.
- Remove batteries when depleted.
- Install/replace the batteries according to the type and quantity stated in table below.
- Be sure to observe proper polarity (+/-) when installing or replacing the batteries. Damage due to improper battery installation may void the warranty on the product.
- For remote control systems, maximize battery life by turning off the receiver when it is not in use.
- For long periods of non-operation, remove batteries from all components for safety.

Component	Type of Battery	Qty.
Ignitor	AAA	1
Remote Control	AAA	2 or 3*
Remote Receiver	AA	4

\*Note: Quantity depends on model of remote control.

### Ignitor

Unscrew ignitor cap and install a AAA battery with the + pointing out. Replace cap.

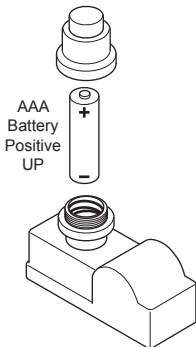


Figure 20 - Installing Battery in Ignitor

### Receiver and Remote Control

Batteries are required in both the Remote Control (Transmitter) (2 AAA size) and Receiver (4 AA size) (see Figure 21).

*Note: Be sure batteries are placed correctly. Reversing the batteries can cause damage to the receiver and remote. Replace all batteries on a yearly basis or sooner.*

Position the slide switch on the front of the receiver box in the ON position before installing batteries. Once the batteries are installed you will hear a single beep which indicates the batteries are charged. If you do not hear a beep, replace with new batteries.

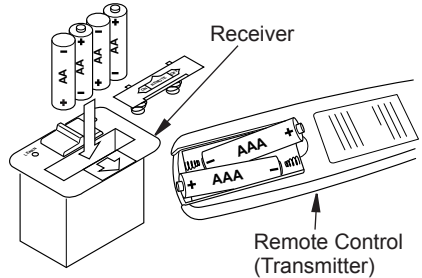


Figure 21 - Installing Batteries in Remote Control and Receiver

## OPERATION

### FOR YOUR SAFETY READ BEFORE LIGHTING

**⚠ WARNING:** If you do not follow these instructions exactly, a fire or explosion may result causing property damage, personal injury or loss of life.

- A. This appliance has a pilot which must be lighted by hand. When lighting the pilot, follow these instructions exactly.
- B. **BEFORE LIGHTING** smell all around the appliance area for gas. Be sure to smell next to the floor because some gas is heavier than air and will settle on the floor.

#### WHAT TO DO IF YOU SMELL GAS

- Do not try to light any appliance.
- Do not touch any electric switch; do



- not use any phone in your building.
- Immediately call your gas supplier from a neighbor's phone. Follow the gas supplier's instructions.
- If you cannot reach your gas supplier, call the fire department.

- C. Use only your hand to push in or turn the gas control knob. Never use tools. If the knob will not push in or turn by hand, don't try to repair it, call a qualified service technician. Force or attempted repair may result in a fire or explosion.
- D. Do not use this appliance if any part has been under water. Immediately call a qualified service technician to inspect the appliance and to replace any part of the control system and any gas control which has been under water.

### LIGHTING INSTRUCTIONS

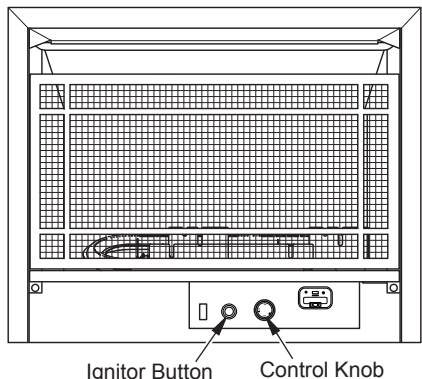
**⚠ WARNING:** You must operate this heater with the screen in place. Make sure screen is installed before running heater.

**NOTICE:** During initial operation of new heater, burning logs will give off a paper-burning smell. Orange flame will also be present. Open damper or window to vent smell. This will only last a few hours.

1. STOP! Read the safety information above.
2. Make sure equipment shutoff valve is fully open.
3. Turn control knob clockwise  to the OFF position.
4. Wait five (5) minutes to clear out any gas. Then smell for gas around heater and near the floor. If you smell gas, STOP! Follow "B" in the safety information above. If you do not smell gas, go to the next step.
5. Turn control knob counterclockwise  to the PILOT position. Press in control knob for five (5) seconds (see Figure 22).


*Note: The first time that the heater is operated after connecting the gas supply, the control knob should be pressed for about thirty (30) seconds. This will allow air to bleed from the gas system. If pilot does not stay lit, refer to [Troubleshooting](#), pages 28 through 31. Also contact a qualified service technician or gas supplier for repairs. Until repairs are made, light pilot with match.*

- If control knob does not pop up when released, contact a qualified service technician or gas supplier for repairs.



**Figure 22 - Control Knob in the OFF Position**

## OPERATION

- With control knob pressed in, push down and release ignitor button. This will light pilot. The pilot is attached to the rear of the front of burner. If needed, keep pressing ignitor button until pilot lights. *Note: If pilot does not stay lit, refer to [Troubleshooting](#), pages 28 through 31. Also contact a qualified service technician or gas supplier for repairs. Until repairs are made, light pilot with match. To light pilot with match, see [Manual Lighting Procedure](#).*
- Keep control knob pressed in for 30 seconds after lighting pilot. After 30 seconds, release control knob. *Note: If pilot goes out, repeat steps 3 through 7. This heater has a safety interlock system. Wait one (1) minute before lighting pilot again.*
- Be sure the slide switch on the front of the receiver is in the ON position.
- Turn control knob counterclockwise  to desired heating level. The main burner should light. Set control knob to any heat level between HI and LO (5 and 1).
- Make sure the heater screen is in place before operating heater.
- If heater will not operate, follow the instructions [To Turn Off Gas To Appliance](#), and call your service technical or gas supplier.

**⚠ CAUTION: Do not try to adjust heating levels by using the equipment shutoff valve.**

**⚠ WARNING: If input gas type is NG, make sure NG pilot burner ignites. If input gas type is LP, make sure LP pilot burner ignites.**

## THERMOSTAT CONTROL OPERATION


The thermostatic control used on this model differs from standard thermostats. Standard thermostats simply turn the burner on and off. The thermostat used on this heater senses the room temperature. At times the room may exceed the set temperature. If so, the burner will shut off. The burner will cycle back on when

room temperature drops below the set temperature. The control knob can be set to any comfort level between HIGH (5) and LOW (1).


*Note: The thermostat sensing bulb measures the temperature depending on housing construction.*

## TO TURN OFF GAS TO APPLIANCE

### Shutting Off Heater

Turn control knob clockwise  to the OFF position.

### Shutting Off Burner Only (pilot stays lit)

Turn control knob clockwise  to the PILOT position.

## MANUAL LIGHTING PROCEDURE

- Remove screen by lifting and pulling forward.
- Follow steps 1 through 5 under [Lighting Instructions](#), page 19.
- With control knob in PILOT position, strike match, and hold near pilot. Press in control knob; pilot should light.
- Keep control knob pressed in for 30 seconds after lighting pilot. After 30 seconds, release control knob.
- Make sure the heater screen is in place before operating heater.

# OPERATION

## REMOTE CONTROL SYSTEM

### Programming the Remote and Receiver

The remote and receiver must be "learned" to one another.

To prepare the receiver box for learning, use a pen or small screwdriver to gently press and hold the learn button until you hear 3 series of beeps.

1. Place the slide switch on the receiver in the remote position (see Figure 23).
2. Turn control knob on the heater to the ON position.
3. Use a pen or small screwdriver to gently press and hold the recessed LEARN button on the face of the receiver for 2-3 seconds. You will hear a beep.
4. Press the ON button on the remote control to light the burner (see Figure 24). You will hear a series of beeps. This will also "learn", or program, the remote and the receiver.

*Note: Remote must be at least 5 feet away from the receiver during the learning process.*

*Note: If the remote control is lost or damaged, the slide switch on the receiver can be used to operate the heater.*

*Note: When batteries are replaced the learning process above must be repeated.*

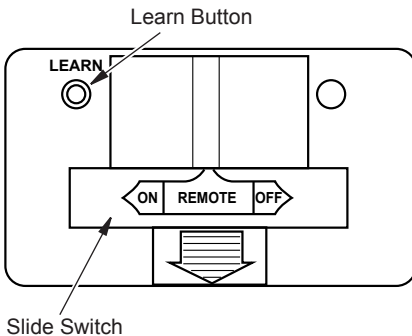


Figure 23 - Receiver

### Remote Control Operation

This appliance must not be used with glass doors in the closed position. This can lead to pilot outages and severe sooting outside the fireplace.

The transmitter operates on 2 AAA batteries.

### Key Settings

**ON** - Operates unit to on position, manually operated solenoid ON.

**OFF** - Operates unit to off position, manually operated solenoid OFF.

**MODE** - Changes unit from manual mode to thermo mode.

**SET** - Sets temperature in thermo mode.

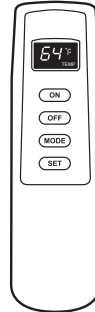


Figure 24 - Remote Control

### LCD Liquid Crystal Display

1. **DISPLAY** Indicates CURRENT room temperature.
2. **°F or °C** Indicates degrees Fahrenheit or Celsius.
3. **FLAME** Indicates burner/valve in operation.
4. **ROOM** Indicates remote is in THERMO operation.
5. **TEMP** Appears during manual operation.
6. **SET** Appears during time the of setting the desired temperature in the thermo operation.

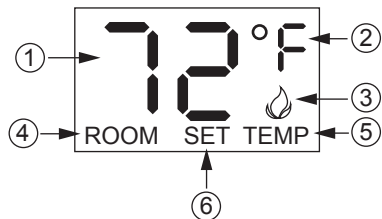


Figure 25 - Remote Control Display

---

---

## OPERATION

---

---

### Setting °F/°C Scale

The factory setting for temperature is °F. To change this setting to °C, press the ON key and the OFF key on the remote control at the same time (see Figure 24, page 21). This will change from °F to °C. Follow this same procedure to change from °C back to °F.

### Manual Function

To operate the system in the manual "MODE" do the following.

#### ON OPERATION

Press the ON key and the appliance flame will come on. During this time the LCD screen will show ON (see Figure 26).

After 3 seconds the LCD screen will default to display room temperature and the word TEMP will show (see Figure 26). The flame icon will appear on LCD screen in manual on mode.

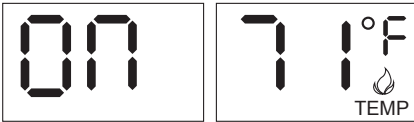


Figure 26 - Manual Mode in ON Operation

#### OFF OPERATION

Press the OFF key and the appliance flame will shut off. During this time the LCD screen will show OF (see Figure 27).

After 3 seconds the LCD screen will default to display room temperature and the word TEMP will show (see Figure 27).

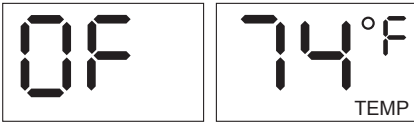


Figure 27 - Manual Mode in OFF Operation

### THERMOSTAT FUNCTION

#### Setting Desired Room Temperature

The remote control system can control the thermostat when the transmitter is in the THERMO mode. The word ROOM must be displayed on the screen.

To set the THERMO MODE and desired room temperature:

1. Press the MODE key until the LCD screen shows the word ROOM. The remote is now in the thermostatic mode.

2. Press and hold the SET key until the desired set temperature is reached. The LCD screen set numbers will increase from 45° to 99° and then restart over at 45°.
3. Release the SET key. The LCD screen will display the set temperature for 3 seconds, then flash the set temperature for 3 seconds, then LCD screen will default to display the room temperature.

#### To Change The Set Temperature

1. Press and hold the SET key until the desired set temperature is reached. The LCD screen set numbers will increase from 45° to 99° then restart over at 45°.
2. Release the SET key. The LCD screen will display the set temperature for 3 seconds, then flash the set temperature for 3 seconds, then the LCD screen will default to display the room temperature.
3. Press the MODE key to disengage the thermo mode. The word ROOM on the LCD screen will not show when the thermo is not in operation.

*Note: The highest SET temperature is 99°F (32 °C) and the lowest temperature is 45°F (6°C).*

### REMOTE CONTROL OPERATION NOTES

The Thermo Feature on the transmitter operates the appliance whenever the ROOM TEMPERATURE varies a certain number of degrees from the SET TEMPERATURE.

This variation is called the "swing" or temperature differential. The normal operating cycle of an appliance may be 4 times per hour depending on how well the room or home is insulated from the cold or drafts. The factory setting for the "swing number" is 2. This represents a temperature variation of +/-2°F (1°C) between SET temperature and ROOM temperature, which determines when the fireplace will be activated. The transmitter has ON and OFF manual functions that are activated by pressing either button on the face of the transmitter. When a button on the transmitter is pressed the word ON or OF will appear on the LCD screen to show while the signal is being sent. Upon initial use, there may be a delay of three seconds before the remote receiver will respond to the transmitter. This is part of the system's design.

## INSPECTING BURNERS

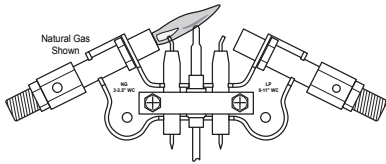
**IMPORTANT:** Owner's should check pilot flame pattern and burner flame pattern often. Incorrect flame patterns indicate the need for cleaning (see Care and Maintenance, page 24) or service.

**⚠ WARNING:** Only a qualified service person should service and repair heater. This includes maintenance requiring replacement or alteration of components.

### PILOT FLAME PATTERN

Figure 28 shows a correct pilot flame pattern. Figure 29 shows an incorrect pilot flame pattern. The incorrect pilot flame is not touching the thermocouple. This will cause the thermocouple to cool, which shuts the heater off. If pilot flame pattern is incorrect, as shown in Figure 29

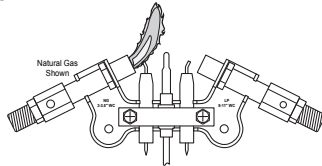
- turn heater off (see To Turn Off Gas to Appliance, page 20)
- see Troubleshooting pages 28 through 31.



**Figure 28 - Correct Pilot Flame Pattern (Natural Gas shown)**

**⚠ WARNING:** If yellow tipping occurs, your heater could produce increased levels of carbon monoxide. If the burner flame pattern shows yellow tipping, follow instructions at bottom of this page.

**Notice:** Do not mistake orange flames with yellow tipping. Dirt or other fine particles enter the heater and burn causing brief patches of orange flame.

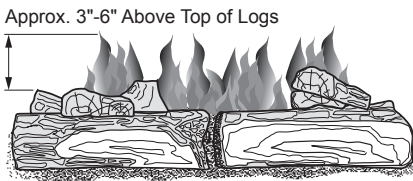


**Figure 29 - Incorrect Pilot Flame Pattern (Natural Gas shown)**

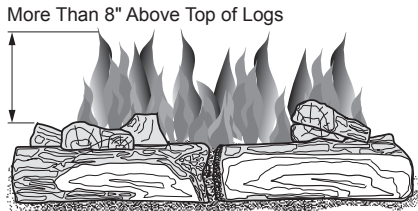
### BURNER FLAME PATTERN

Figure 30 shows a correct burner flame pattern. Figure 31 shows an incorrect burner flame pattern. If burner flame pattern is incorrect then:

- turn heater off (see To Turn Off Gas to Appliance, page 20).
- see Troubleshooting pages 28 through 31.



**Figure 30 - Correct Burner Flame Pattern with Control Knob Set to HI (5)**



**Figure 31 - Incorrect Burner Flame Pattern with Control Knob Set to HI (5)**

### BURNER PRIMARY AIR HOLES

Air is drawn into the burner through the holes in the fitting at the entrance to the burner. These holes may become blocked with dust or lint. Periodically inspect these holes for any blockage and clean as necessary. Blocked air holes will create soot.

## CARE AND MAINTENANCE

**⚠ WARNING:** Turn off heater and let cool before servicing.

**⚠ CAUTION:** You must keep control areas, burner, and circulating air passageways of heater clean. Inspect these areas of heater before each use. Have heater inspected yearly by a qualified service technician. Heater may need more frequent cleaning due to excessive lint from carpeting, bedding material, pet hair, etc.

**⚠ WARNING:** Failure to keep the primary air opening(s) of the burner(s) clean may result in sooting and property damage.

### MAIN BURNER

Periodically inspect all burner flame holes with the heater running. All slotted burner flame holes should be open with yellow flame present. All round burner flame holes should be open with a small blue flame present. Some

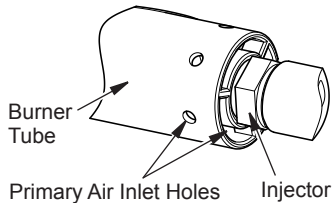
burner flame holes may become blocked by debris or rust, with no flame present. If so, turn off the heater and let it cool, and remove blockage or replace burner. Blocked burner flame holes will create soot.

### CLEANING BURNER PILOT AIR INLET HOLE

We recommend that you clean the unit every 2,500 hours of operation or every three months. We also recommend that you keep the burner tube and pilot assembly clean and free of dust and dirt. To clean these parts we recommend using compressed air no greater than 30 PSI. Your local computer store, hardware store, or home center may carry compressed air in a can. You can use a vacuum cleaner in the blow position. If using compressed air in a can, please follow the directions on the can. If you don't follow directions on the can, you could damage the pilot assembly.

1. Shut off the unit, including the pilot. Allow the unit to cool for at least thirty minutes.
2. Inspect burner, pilot and primary air inlet holes on injector for dust and dirt (see Figure 32).
3. Blow air through the ports/slots and holes in the burner. Also clean the pilot assembly.

4. Check the injector holder located at the end of the burner tube again. Remove any large particles of dust, dirt, lint, or pet hair with a soft cloth or vacuum cleaner nozzle.
5. Blow air into the primary air holes on the injector holder.
6. In case any large clumps of dust have now been pushed into the burner. Repeat steps 3 and 4.



**Figure 32 - Burner and Injector Holder**



---

---

## CARE AND MAINTENANCE

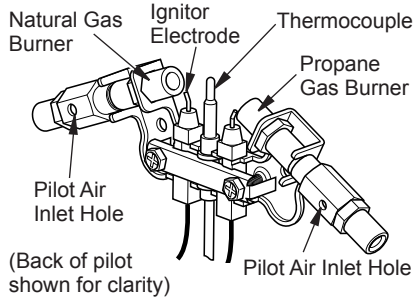
---

---

### ODS/PILOT

Use a vacuum cleaner, pressurized air, or a small, soft bristled brush to clean.

A yellow tip on the pilot flame indicates dust and dirt in the pilot assembly. There is a small pilot air inlet hole about 2" from where the pilot flame comes out of the pilot assembly (see Figure 33). With the unit off, lightly blow air through the air inlet hole. You may blow through a drinking straw if compressed air is not available.



**Figure 33 - Pilot Inlet Air Hole**

### CABINET

#### Air Passageways

Use a vacuum cleaner or pressurized air to clean.

#### Exterior

- Use a soft cloth dampened with a mild soap and water mixture.
- Wipe the cabinet to remove dust.

### LOGS

- If you remove logs for cleaning, refer to *Installing Logs*, page 17, to properly replace logs.
- Replace log(s) if broken or chipped (dime-size or larger).

### BLOWER (OPTIONAL ACCESSORY)

Refer to blower manual.

# ELECTRICAL

## ELECTRICAL CONNECTION FOR STOVES EQUIPPED WITH A BLOWER

**⚠ Do not use this stove if any part of it has been under water. Immediately call a qualified service technician to inspect the stove and replace any part of the electrical system which has been under water.**

### GROUNDING INSTRUCTIONS

This stove is for use on 120 volts. The cord has a plug as shown at A in Figure 34. An adapter as shown at C is available for connecting three-blade grounding-type plugs to two-slot receptacles. The green grounding lug extending from the adapter must be connected to a permanent ground such as

a properly grounded outlet box. The adapter should not be used if a three-slot grounded receptacle is available.

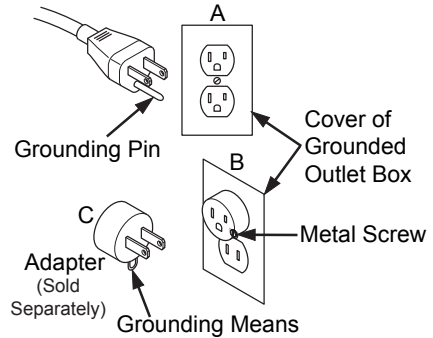


Figure 34 - Grounded Electrical Outlet

### ELECTRICAL WIRING

Any electrical re-wiring of this stove must be done by a qualified electrician. This wiring must be done in accordance with local codes and/or in Canada with the current *CSA C22.1 Canadian Electrical Code*, and for US installations, the *National Electrical Code ANSI/NFPA NO 70*.

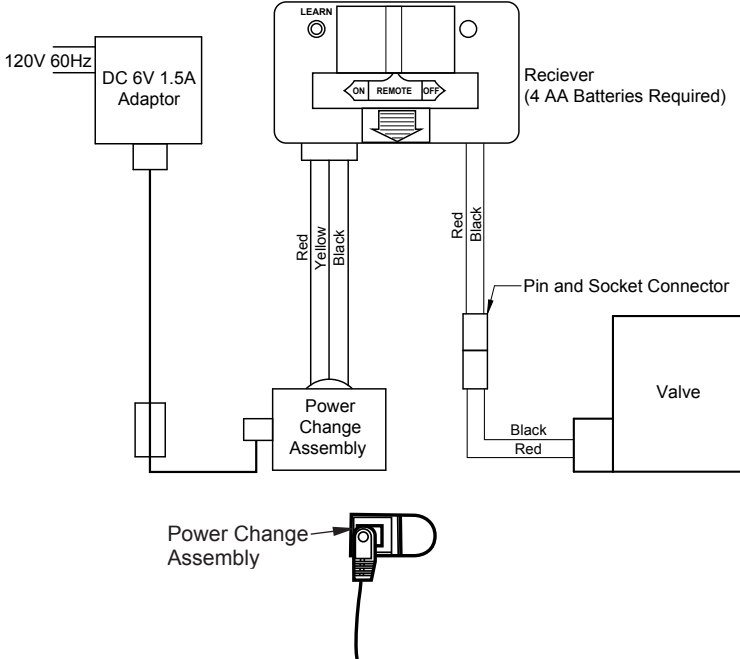
**⚠ WARNING: If repairing or replacing any electrical component or wiring, the original wire routing, color coding and securing locations must be followed.**

**⚠ CAUTION: Label all wires prior to disconnection when servicing controls. Wiring errors can cause improper and dangerous operation.**

## ELECTRICAL

**⚠ WARNING: Never attempt to service stove while it is plugged in, operating, or hot. Burns and electrical shock could result. Only a qualified service person should service or repair stove.**

Verify proper operation after servicing. If any of the original wire as supplied with the stove must be replaced, it must be replaced with a wire of at least a 105° C temperature rating.



## TROUBLESHOOTING

**⚠ WARNING: If you smell gas:**

- Shut off gas supply.
- Do not try to light any appliance.
- Do not touch any electrical switch; do not use any phone in your building.
- Immediately call your gas supplier from a neighbor's phone. Follow the gas supplier's instructions.
- If you cannot reach your gas supplier, call the fire department.

**⚠ WARNING: Only a qualified service technician should service and repair heater. Make sure that power is turned off before proceeding. Turn off and let cool before servicing.**

**⚠ CAUTION: Never use a wire, needle, or similar object to clean ODS/pilot. This can damage ODS/ pilot unit.**

*IMPORTANT:* Operating heater where impurities in air exist may create odors. Cleaning supplies, paint, paint remover, cigarette smoke, cements and glues, new carpet or textiles, etc., create fumes. These fumes may mix with combustion air and create odors.

*Note:* All troubleshooting items are listed in order of operation.

Problem	Possible Cause	Corrective Action
Using natural gas and pilot will not light.	Inlet pressure exceeds 9.5" WC.	Bypass pressure switch. See instructions below.

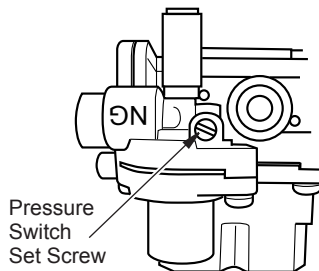
### Pressure Switch

When using natural gas (NG), there is a pressure switch that acts to turn off the gas flow to the pilot if the inlet pressure exceeds 9.5" WC. This is to prevent the operation of the unit on the wrong gas (propane). If your natural gas supply exceeds 9.5" WC the unit will not operate. Either contact your gas supplier to check and adjust the inlet pressure or a qualified service technician can bypass the pressure switch.

Before attempting to bypass the pressure switch, make sure the type of gas being used is correct. Check to make sure the connection fitting is in the correct inlet on the regulator. Refer to *Connecting to Gas Supply*, page 14.

Only a qualified installer should bypass the pressure switch. To bypass the pressure switch locate the set screw on the regulator. Use a small flat bladed screw driver to turn the set screw counterclockwise 2 turns. This will bypass the pressure switch function.

The entire gas delivery piping including connections inside the heater should be leak tested by the qualified installer. After leak testing the qualified installer should light the appliance. Refer to the correct flame pattern as illustrated on page 23. All flame patterns should be safely inside the product. If for any reason they are not, stop use of the appliance and call for repairs.



**Figure 35 - Gas Regulator Pressure Switch**

## TROUBLESHOOTING

Problem	Possible Cause	Corrective Action
When ignitor button is pressed in, there is no spark at ODS/pilot	<ol style="list-style-type: none"> <li>1. Ignitor electrode is positioned wrong. Ignitor electrode is broken.</li> <li>2. Ignitor electrode is not connected to ignitor cable.</li> <li>3. Ignitor cable is pinched or wet.</li> <li>4. Broken ignitor cable.</li> <li>5. Bad piezo ignitor.</li> <li>6. Low battery.</li> </ol>	<ol style="list-style-type: none"> <li>1. Replace electrode.</li> <li>2. Replace ignitor cable</li> <li>3. Free ignitor cable if pinched by any metal or tubing. Keep ignitor cable dry.</li> <li>4. Replace ignitor cable.</li> <li>5. Replace piezo ignitor.</li> <li>6. Replace battery.</li> </ol>
When ignitor button is pressed in there is a spark at ODS/pilot but no pilot flame present.	<ol style="list-style-type: none"> <li>1. Gas supply is turned off or equipment shutoff valve is closed.</li> <li>2. Control knob not fully pressed in while pressing ignitor button.</li> <li>3. Air in gas lines (new installation or recent gas interruption).</li> <li>4. ODS / pilot is clogged.</li> <li>5. Incorrect inlet gas pressure or inlet regulator is damaged.</li> <li>6. Control knob not in PILOT position.</li> <li>7. Depleted gas supply (propane).</li> </ol>	<ol style="list-style-type: none"> <li>1. Turn on gas supply or open equipment shutoff valve.</li> <li>2. Fully press in control knob while pressing ignitor button.</li> <li>3. Continue holding down control knob. Repeat igniting operation until air is removed.</li> <li>4. Clean ODS/pilot (see <u>Care and Maintenance</u>, page 24) or replace ODS/pilot assembly.</li> <li>5. Check inlet gas pressure or replace inlet gas regulator.</li> <li>6. Turn control knob to PILOT position.</li> <li>7. Contact local propane gas company.</li> </ol>
ODS/pilot lights but flame goes out when control knob is released.	<ol style="list-style-type: none"> <li>1. Control knob is not fully pressed in.</li> <li>2. Control knob is not pressed in long enough.</li> <li>3. Equipment shutoff valve is not fully open.</li> <li>4. Thermocouple connection is loose at control valve.</li> <li>5. Pilot flame not touching thermocouple, which allows thermocouple to cool, causing pilot flame to go out. This problem could be caused by one or both of the following: A) Low gas pressure B) Dirty or partially clogged ODS/pilot</li> <li>6. Thermocouple damaged.</li> <li>7. Control valve damaged.</li> </ol>	<ol style="list-style-type: none"> <li>1. Press in control knob fully.</li> <li>2. After ODS/pilot lights, keep control knob pressed in 30 seconds.</li> <li>3. Fully open equipment shutoff valve.</li> <li>4. Hand tighten until snug, and then tighten 1/4 turn more.</li> <li>5. A) Contact local natural or propane gas company  B) Clean ODS/pilot (see <u>Care and Maintenance</u>, page 24) or replace ODS/pilot assembly</li> <li>6. Replace thermocouple.</li> <li>7. Contact customer service.</li> </ol>

## TROUBLESHOOTING

Problem	Possible Cause	Corrective Action
Burner(s) does not light after ODS/pilot is lit	<ol style="list-style-type: none"> <li>1. Burner orifice is clogged.</li> <li>2. Burner orifice diameter is too small.</li> <li>3. Inlet gas pressure is too low.</li> </ol>	<ol style="list-style-type: none"> <li>1. Clean burner orifice (see <i>Care and Maintenance</i>, page 24) or replace burner orifice.</li> <li>2. Replace burner orifice.</li> <li>3. Contact local gas supplier.</li> </ol>
Delayed ignition of burner(s).	<ol style="list-style-type: none"> <li>1. Manifold pressure is too low.</li> <li>2. Burner orifice is clogged.</li> </ol>	<ol style="list-style-type: none"> <li>1. Contact local gas supplier.</li> <li>2. Clean burner (see <i>Care and Maintenance</i>, page 24) or replace burner orifice.</li> </ol>
Burner backfiring during combustion	<ol style="list-style-type: none"> <li>1. Burner orifice is clogged or damaged.</li> <li>2. Burner is damaged.</li> <li>3. Gas regulator is damaged.</li> </ol>	<ol style="list-style-type: none"> <li>1. Clean burner orifice (see <i>Care and Maintenance</i>, page 24) or replace burner orifice.</li> <li>2. Contact dealer or customer service.</li> <li>3. Replace gas regulator.</li> </ol>
High yellow flame during burner combustion	<ol style="list-style-type: none"> <li>1. Not enough air.</li> <li>2. Gas regulator is defective.</li> <li>3. Inlet gas pressure is too low.</li> </ol>	<ol style="list-style-type: none"> <li>1. Check burner for dirt and debris. If found, clean burner (see <i>Care and Maintenance</i>, page 24).</li> <li>2. Replace gas regulator.</li> <li>3. Contact local gas supplier.</li> </ol>
Gas odor during combustion.	<ol style="list-style-type: none"> <li>1. Foreign matter between control valve and burner.</li> <li>2. Gas leak. (See <i>Warning Statement</i> at top of page 26).</li> </ol>	<ol style="list-style-type: none"> <li>1. Take apart gas tubing and remove foreign matter.</li> <li>2. Locate and correct all leaks (see <i>Checking Gas Connections</i>, page 16).</li> </ol>
Slight smoke or odor during initial operation	<ol style="list-style-type: none"> <li>1. Residues from manufacturing process.</li> </ol>	<ol style="list-style-type: none"> <li>1. Problem will stop after a few hours of operation.</li> </ol>
Heater produces a whistling noise when burner is lit..0	<ol style="list-style-type: none"> <li>1. Turning control knob to high (5) position when burner is cold.</li> <li>2. Air in gas line.</li> <li>3. Air passageways on heater are blocked.</li> <li>4. Dirty or partially clogged burner orifice.</li> </ol>	<ol style="list-style-type: none"> <li>1. Turn control knob to low (1) position and let warm up for a minute.</li> <li>2. Operate burner until air is removed from line. Have gas line checked by local gas supplier.</li> <li>3. Observe minimum installation clearances (Figure 5, page 9)</li> <li>4. Clean burner (see <i>Care and Maintenance</i>, page 24) or replace burner orifice.</li> </ol>

## TROUBLESHOOTING

Problem	Possible Cause	Corrective Action
Heater produces a clicking/ticking noise just after burner is lit or shut off.	1. Metal is expanding while heating or contracting while cooling.	1. This is common with most heaters. If noise is excessive, contact qualified service technician.
White powder residue forming within burner box or on adjacent walls or furniture	1. When heated, the vapors from furniture polish, wax, carpet cleaners, etc., turn into white powder residue.	1. Turn heater off when using furniture polish, wax, carpet cleaner or similar products.
Heater produces unwanted odors.	<ol style="list-style-type: none"> <li>1. Heater is burning vapors from paint, hair spray, glues, etc. See IMPORTANT statement, page 26.</li> <li>2. Gas leak. See <i>Warning Statement</i> at the top of page 26.</li> <li>3. Low fuel supply.</li> </ol>	<ol style="list-style-type: none"> <li>1. Ventilate room. Stop using odor causing products while heater is running.</li> <li>2. Locate and correct all leaks (see <i>Checking Gas Connections</i>, page 16).</li> <li>3. Refill supply tank (Propane models).</li> </ol>
Heater shuts off in use (ODS operates).	<ol style="list-style-type: none"> <li>1. Not enough fresh air is available.</li> <li>2. Low line pressure.</li> <li>3. ODS/pilot is partially clogged.</li> </ol>	<ol style="list-style-type: none"> <li>1. Open window and/or door for ventilation.</li> <li>2. Contact local gas supplier.</li> <li>3. Clean ODS/pilot (see <i>Care and Maintenance</i>, page 24).</li> </ol>
Gas odor exists even when control knob is in OFF position.	<ol style="list-style-type: none"> <li>1. Gas leak. See <i>Warning Statement</i> at top of page 26.</li> <li>2. Control valve is defective.</li> </ol>	<ol style="list-style-type: none"> <li>1. Locate and correct all leaks (see <i>Checking Gas Connections</i>, page 16).</li> <li>2. Contact customer service.</li> </ol>
Moisture/condensation noticed on windows.	1. Not enough combustion/ventilation air.	1. Refer to <i>Air for Combustion and Ventilation</i> requirements, page 6 .

## SERVICE HINTS

### When Gas Pressure Is Too Low

- pilot will not stay lit
- burners will have delayed ignition
- fireplace will not produce specified heat
- propane gas supply might be low (propane units only)

You may feel your gas pressure is too low. If so, contact your local gas supplier.

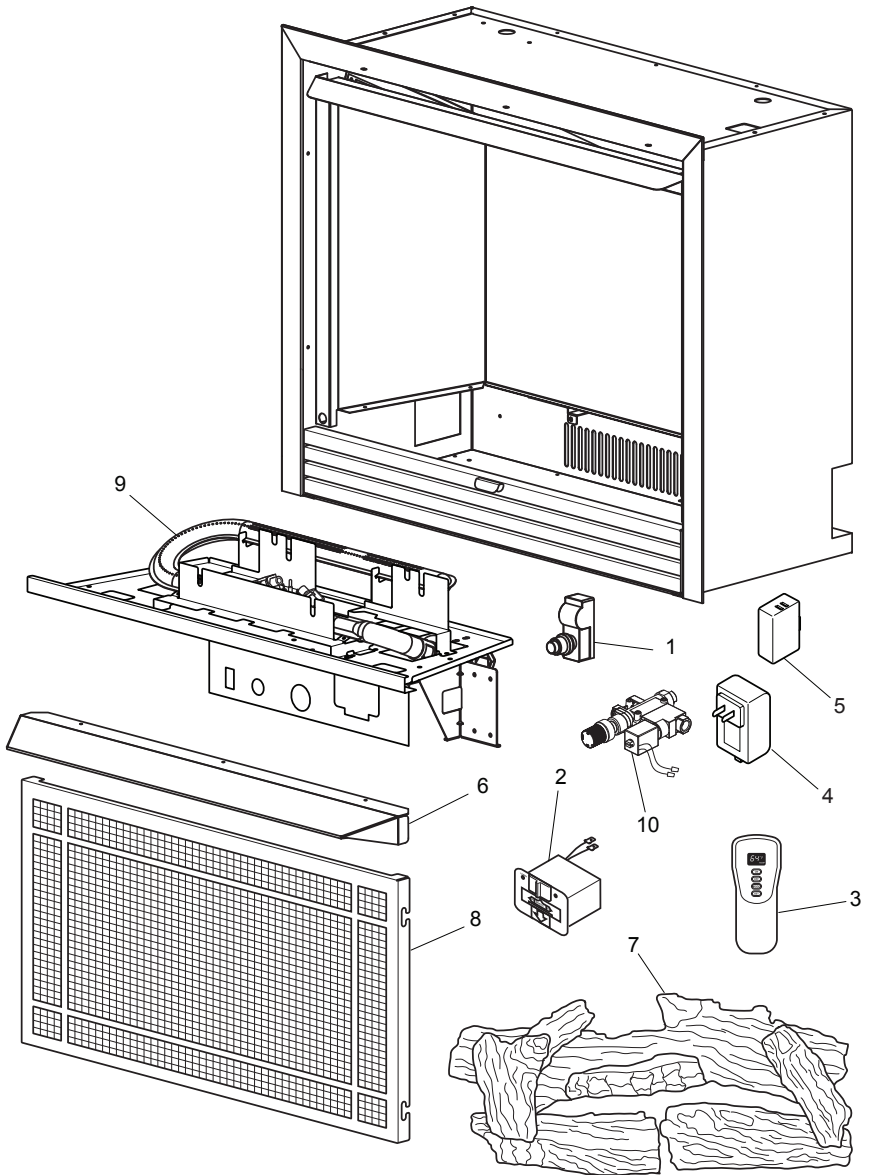
## TECHNICAL SERVICE

You may have further questions about installation, operation, or troubleshooting. If so, contact Factory Buys Direct at 1-855-607-6557.

When calling, please have your model and serial numbers of your heater ready.

**PARTS**

**MODEL FDF300R**





---

---

## PARTS

---

---

### MODEL FDF300R

This list contains replaceable parts for your heater. When ordering replacement parts, follow the instructions listed under Replacement Parts, page 34 of this manual.

ITEM	PART #	DESCRIPTION	QTY
1	PIMDNI-01	Piezo Ignitor	1
2	RG04-2M	Receiver	1
3	RG04-1T	Remote Control	1
4	QX18W060150FU	6V DC Adapter	1
5	RG04-1M-PA	Power Change Assembly	1
6	FB28D04-B	Hood	1
7	FB28D500-D	Log Set	1
8	161260-02HT	Screen	1
9	162405-01	Gas Train Assembly	1
10	161311-01	Solenoid Valve Control (MRT-01)	1
<b>PART AVAILABLE - NOT SHOWN</b>			
	160960-01	Inlet Cover Assembly	1

---

---

## REPLACEMENT PARTS

---

---

*Note: Use only original replacement parts. This will protect your warranty coverage for parts replaced under warranty.*

### **PARTS UNDER WARRANTY**

Contact authorized dealers of this product. If they can't supply original replacement parts, call Customer Service toll free at 1-855-607-6557 for referral information.

When calling Customer Service or your dealer, have ready:

- Your name
- Your address
- Model and serial number of your heater
- How heater was malfunctioning
- Type of gas supply and Propane tank size
- Purchase date

Usually, we will ask you to return the defective part to the factory

### **PARTS NOT UNDER WARRANTY**

Contact authorized dealers of this product. If they can't supply original replacement part(s) call Customer Service toll free at 1-855-607-6557 for referral information.

When calling Customer Service have ready:

- Model number of your heater
- The replacement part number

---

---

## ACCESSORIES

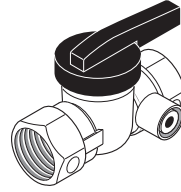
---

---

Purchase these heater accessories from your local dealer. If they can not supply these accessories, contact Factory Buys Direct at 1-855-607-6557 for information.

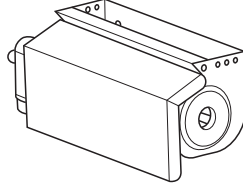
### EQUIPMENT SHUTOFF VALVE

For all models. Equipment shutoff valve with 1/2" NPT tap.



### OPTIONAL FAN KIT

Optional fan kit part FIB100. The fan has 3 settings ON/OFF/Auto.



---

---

# WARRANTY

---

---

## KEEP THIS WARRANTY

Model \_\_\_\_\_

Serial No. \_\_\_\_\_

Date Purchased \_\_\_\_\_

Keep receipt for warranty verification.

## REGISTER YOUR PRODUCT AT [WWW.FACTORYBUYSDIRECT.COM](http://WWW.FACTORYBUYSDIRECT.COM)

### FACTORY BUYS DIRECT LIMITED WARRANTIES

#### New Products

**Standard Warranty:** Factory Buys Direct warrants this new product and any parts thereof to be free from defects in material and workmanship for a period of one (1) year from the date of first purchase from an authorized dealer provided the product has been installed, maintained and operated in accordance with Factory Buys Direct's warnings and instructions.

For products purchased for commercial, industrial or rental usage, this warranty is limited to 90 days from the date of first purchase.

#### Factory Reconditioned Products

**Limited Warranty:** Factory Buys Direct warrants factory reconditioned products and any parts thereof to be free from defects in material and workmanship for a period 30 days from the date of first purchase from an authorized dealer provided the product has been installed, maintained and operated in accordance with Factory Buys Direct's warnings and instructions. No return will be authorized. Parts will be provided to repair the product.

#### Terms Common to All Warranties

The following terms apply to all of the above warranties:

Always specify model number and serial number when contacting the manufacturer. To make a claim under this warranty, the bill of sale or other proof of purchase must be presented.

This warranty is extended only to the original retail purchaser when purchased from an authorized dealer, and only when installed by a qualified installer in accordance with all local codes and instructions furnished with this product.

This warranty covers the cost of part(s) required to restore this product to proper operating condition and an allowance for labor when provided by a Factory Buys Direct Authorized Service Center or a provider approved by Factory Buys Direct. Warranty parts must be obtained through authorized dealers of this product and/or Factory Buys Direct who will provide original factory replacement parts. Failure to use original factory replacement parts will void this warranty.

Traveling, handling, transportation, diagnostic, material, labor and incidental costs associated with warranty repairs, unless expressly covered by this warranty, are not reimbursable under this warranty and are the responsibility of the owner.

Excluded from this warranty are products or parts that fail or become damaged due to misuse, accidents, improper installation, lack of proper maintenance, tampering or alteration(s).

This is Factory Buys Direct's exclusive warranty, and to the full extent allowed by law; this express warranty excludes any and all other warranties, express or implied, written or verbal and limits the duration of one and all implied warranties, including warranties of merchantability and fitness for a particular purpose to any (1) year on new products and 30 days on factory reconditioned products from the date of first purchase.

Factory Buys Direct makes no other warranties regarding this product.

Factory Buys Direct's liability is limited to the purchase price of the product and Factory Buys Direct shall not be liable for any other damages whatsoever under any circumstances including direct, indirect, incidental, or consequential damages.

Some states do not allow limitations on how long an implied warranty lasts or the exclusion or limitation of incidental or consequential damages, so the above limitation or exclusion may not apply to you.

This warranty gives you specific legal rights, and you may also have other rights which vary from state to state.



**FACTORY  
BUYS  
DIRECT.COM**

Factory Buys Direct  
2701 Industrial Drive  
Bowling Green, KY 42101  
1-855-607-6557

200253-01  
Rev. F  
08/18