



Garden Party™ 13ft X 13ft

12ft 9in Wide x 12ft 9in Deep x 6ft3in Side Height /
10ft4in Center Height



King Canopy Item #: GP1313

With 4 Legs, Foot Pads, Cover & Screens.

Distributed by:
PIC America, LTD.
8009 Purfoy Road • Fuquay-Varina, NC 27526
1-800-800-6296 • www.kingcanopy.com

WARNING:

Keep all flame and heat sources away from this tent fabric. Meets the flammability requirements of CPAI-84. It is not fire proof. The fabric will burn if left in continuous contact with any flame source.



PARTS LIST



6X6PC	12 pc	78" Pipe 1 3/8"
6X6PC-SW	4 pc	78" Swedge Pipe 1 3/8"
2X9PC	4 pc	33" Swedge Pipe 1 3/8"
4WCPC	4 pc	4-Way Fittings 1 3/8"
FOOTPC	4 pc	Metal Foot Pads 1 3/8"
TOP4WPC	1 pc	1 Piece 4-Way Fitting 1 3/8"
GPT13	1 pc	100% Polyester Cover
GPT13SCREENS	4 pc	Screen Walls
STAKE	16 pc	Nail Stakes

FRAME ASSEMBLY



1. Arrange all pipes and fittings on the ground as in Figure #1 below.
2. Starting with the center peak 4-way fitting (TOP4WPC) connect all 4 pipe sections (6X6PC & 2X9PC) that form the center peak into the center peak 4-way fitting (TOP4WPC). Figure #2 below.
3. Starting at one corner, attach a 4-way corner fitting (4WCPC) and proceed to assemble the perimeter of the canopy with the 6X6PC, 6X6PC-SW and remaining 4WCPC fittings (see figure #3 below). When completed, the frame should look like the one in figure #4 below.
4. Place the cover over the frame and temporarily secure at the corners as shown in figure #5.

Figure #1

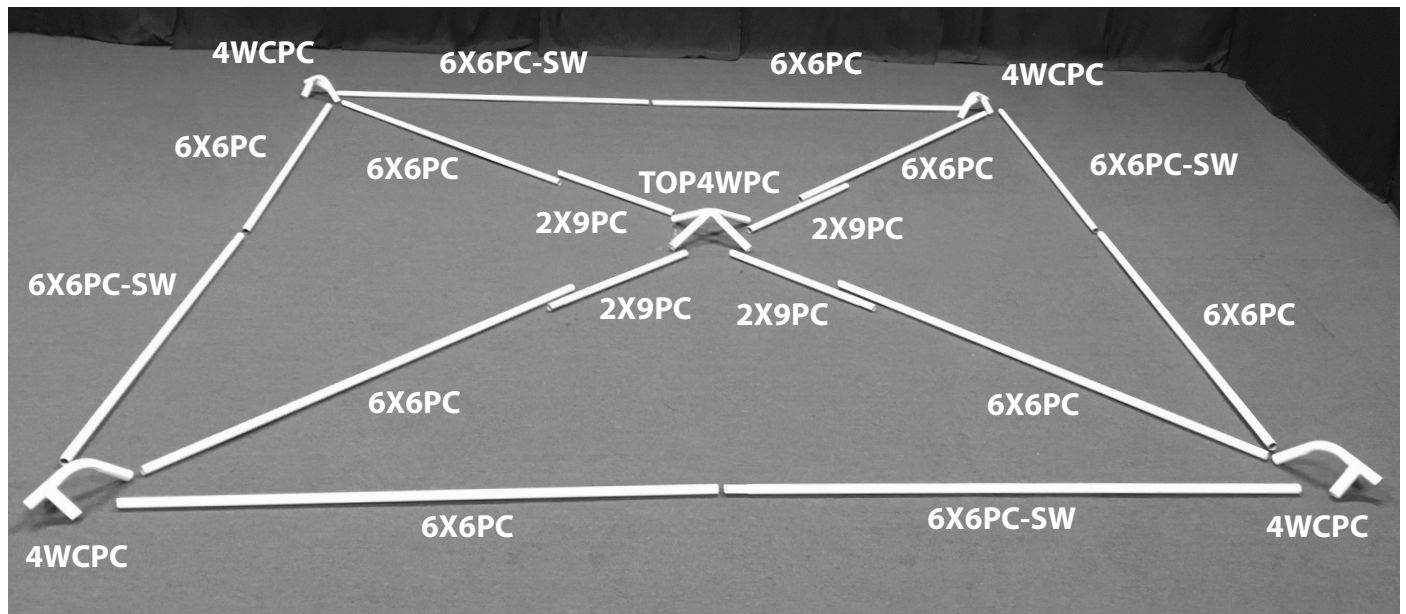

Figure #2

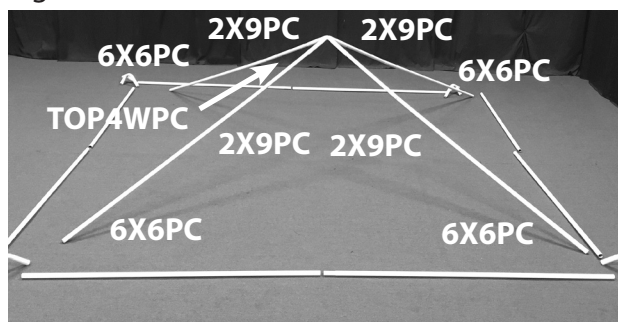

Figure #3

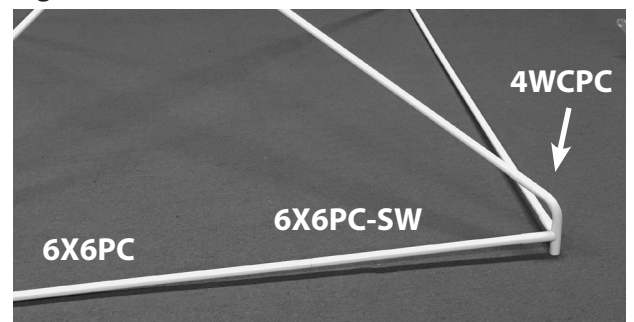

Figure #4

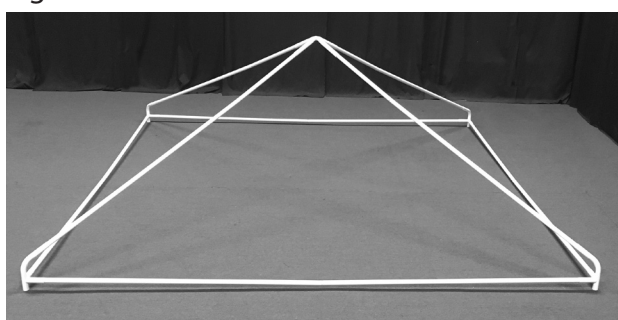

Figure #5





LEG & SCREEN ASSEMBLY

5. Attach the 4 foot pads (FOOTPC) to each of the 4 leg pipes (6X6PC) and tighten the eye bolts to secure them. Lift one side of the canopy and insert the legs into the corner 4-way fittings (see figure #6). Repeat the step for the opposite side. Now go ahead and securely tie the straps at the corners of the cover as shown in figure #7. You are now able to use the canopy if you do not want to attach screens at this time (see figure #7). To attach the screens please continue to the next step.
6. Standing at the exterior corner of the canopy, flip up the corners of the valances until the velcro strip is exposed (see figure #8). Take a screen wall section and locate the center of it where there is a space between the hook and loop strip. This is the corner of the screen wall. Hold the wall with the hook and loop tape facing you and fold it over, attaching it to the hook and loop strip of the valance, aligning the corner seam of the screen wall with the corner seam of the cover and proceed to attach the screen walls as shown in figures #9 and 10. Proceed to attach the remaining 3 screens the same way. When all the screens have been attached you may fold the valances back down and adjust the fit.
7. Connect and close the zippers at the center of each side starting at the top of the screen and zipping downward. You may have to adjust the screens if they were not properly aligned at the corners. (See figure #11).

Figure #6

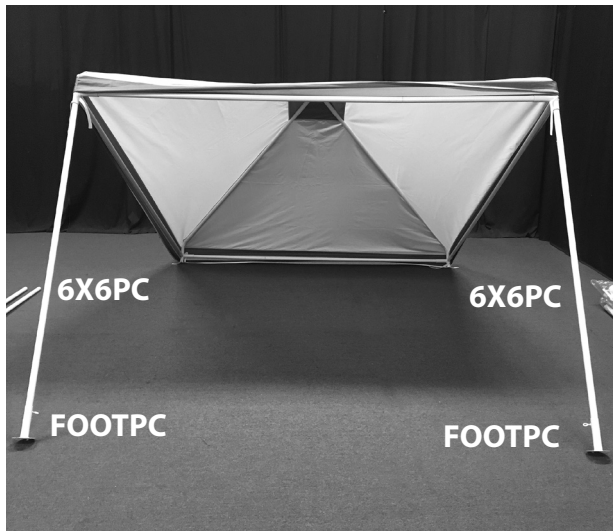

Figure #7



Figure #8

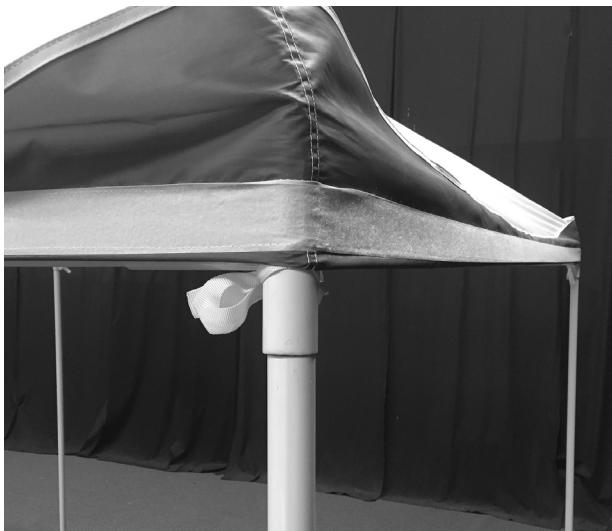
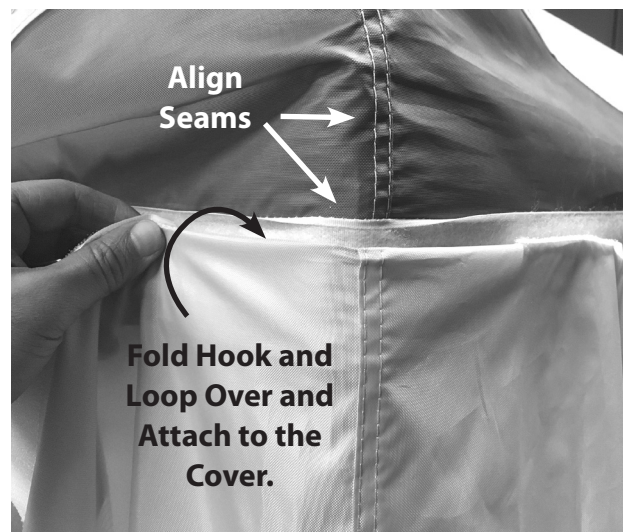

Figure #9



SCREEN ASSEMBLY



8. Your enclosed canopy should now look like the one in figure #12 below. To set up your canopy with the screens open you can “scallop” the screens and tie them at the corners for a more decorative look. Begin by unzipping and detaching the hook and loop strip of one side of the screen (figure #13) and proceed to “scallop” the screen in 2 - 3 inch intervals. Repeat the step for the other side of the screen until your corner looks as shown in figures #14 and 15 on next page. Locate the wide belt like strap on the center inside corner of the screen. Gather the center of your screen towards the leg where the strap is and wrap the strap around the screen and leg. Attach the strap to the hook and loop tape on the belt to hold in place. (See figures #16 - 18 on next page). Repeat step at the other 3 corners. Your completely open canopy should now look like the one in figure #19.
9. If leaving you canopy up for an extended period of time please see our anchoring instructions on the next page. We have also included stakes to hold your screens in place if set up on grass or soft surfaces. These can be staked through the grommets on the lower part of your screen walls.

Figure #10



Figure #11



Figure #12



Figure #13



SCREEN ASSEMBLY



Figure #14



Figure #15



Figure #16



Figure #17



Figure #18



Figure #19





ANCHORING YOUR UNIT

This canopy is designed for use as a temporary structure. After assembly, the canopy **MUST BE** securely anchored to the ground to prevent damage from winds. Your canopy will act like a kite in the wind if not properly and securely anchored to the ground. Severe winds will cause the frame to twist and unanchored legs will fall, thereby collapsing the canopy. If severe winds are expected, you must remove the cover from the frame to prevent damage.

Step 1

Measure out at least 36in from each leg. Screw each anchor into the ground leaving 2in between the ground and the eye of each anchor. We strongly recommend that your unit be anchored 36in from each leg although this may not be possible in all cases. **DO** install anchors as close to 36in away from legs as possible.

Step 2

Tie anchor cable or rope around the connector at the top of each leg of the canopy.

Step 3

Securely tie the other end of the cable or rope through the eye of the anchor and pull tight.

Step 4

Now, continue to screw each anchor into the ground until the eye of the anchor is flush with the ground. This will secure the anchor rope even tighter.

NOTE: You should check and tighten the rope frequently to ensure maximum stability of your canopy and to protect against wind damage.

**ANCHOR KIT NOT INCLUDED
WITH THIS CANOPY**

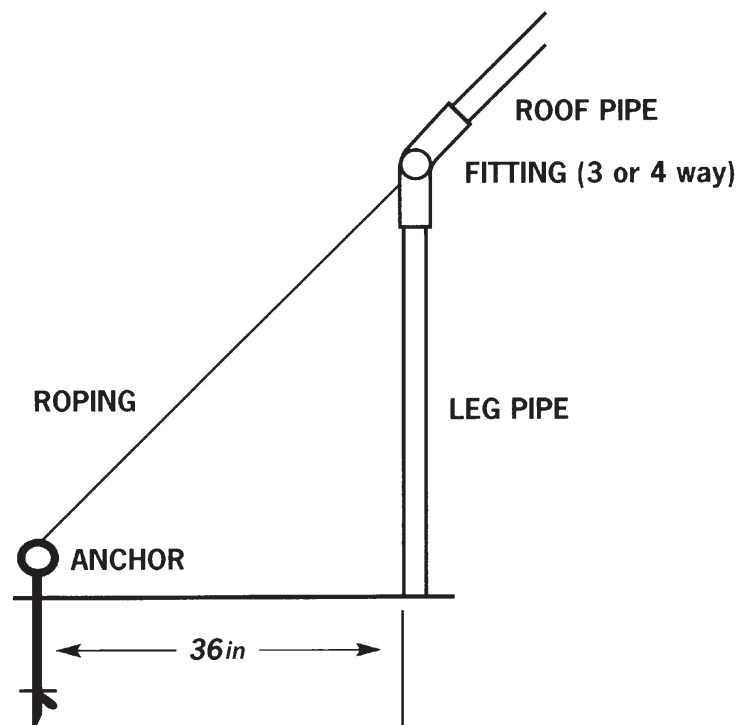

IMPORTANT NOTICE: PLEASE READ CAREFULLY



We are confident that you will be completely satisfied with your King Canopy unit. Please take a moment to read the very important information below, and call us with any questions you may have.

King Canopy/PIC America, LTD. has no control over wind, snow, ice, rain or any other weather condition and we are in no way responsible for any damage caused by the canopy or to the canopy. We suggest you contact your insurance carrier just as you would for any other outside structure.

OTHER PRECAUTIONS WHICH MUST BE FOLLOWED:

Keep all flame and heat sources away from this tent fabric. The tent fabric will burn if left in continuous contact with any flame source.

DO NOT cook underneath or near canopy.

DO NOT store or use flammable liquids underneath or near canopy.

DO NOT ignite or store fireworks underneath or near canopy.

DO NOT use bleach to clean cover.

DO NOT dry clean cover.

DO NOT wash cover in washing machine or dry in dryer. Hand wash with mild soap and water only.

DO NOT allow rain water, snow or ice to accumulate on top of cover.

DO NOT hang or suspend anything from the frame, grommets, truss system or ball straps of the unit.

REMOVE canopy cover before a storm, or disassemble entire canopy unit if possible.

REMOVE rain water, snow and ice from canopy cover.

This is a temporary structure and is not recommended for use as a permanent structure.



PRODUCT INFORMATION

Defective Parts

We try our best to eliminate any defective parts that are shipped with our products. If, however, you should find a defective part, we will replace – free of charge – any part which is defective. You will need to provide proof of purchase showing date of purchase and provide us with detailed description of the defective component. Your replacement will be shipped by ground shipping, freight prepaid. Next day or express shipping will require freight collect and paid for by you, the consumer. Damages from improper anchoring, strong winds, snow, ice or rain are not considered defects.

Improper Anchoring, Strong Winds, Rain Snow, or Ice

King Canopy/PIC America, LTD. does not guarantee these canopies under strong weather conditions. These canopies are designed to protect against damages caused by sun, rain, tree sap, birds, etc. They are not designed to hold roof loads that accompany snow, ice or heavy rains. If your canopy is not anchored securely, it can be lifted by the wind and will fly away. If your canopy takes flight, we are not responsible for any replacement. If you know strong weather is predicted, remove the cover or take down the canopy unit completely. The cover is designed to be quickly and easily removed.

Warranty

All components of this canopy feature a 1-year limited warranty and are warranted to be free from defects in material and workmanship for a period of 1-year. You must complete and return the enclosed warranty card promptly after purchase. Please retain your proof of purchase receipt; you will be asked to provide this receipt in order to obtain warranty service.

Non-Warranty Replacement Parts

If after expiration of the warranty period, you require replacement parts please contact us at 1-800-800-6296. We stock replacement parts and make them available to you at discounted prices. Our customer service department will be pleased to assist you in any way possible.

Certain regions of the country are extremely hard on covers of any kind. Normal wear and tear is not covered under the warranty, and should be expected.

In order to receive a discounted or free replacement part, you may be asked to return the part, freight prepaid, to our warehouse for inspection before we will send a replacement. You must, in all cases, provide a copy of your receipt showing the date of purchase, model number and price.

For missing parts, replacement parts or any questions:

Please Call 8:00am – 5:00pm EST, Monday – Friday
1-800-800-6296 or 1-919-552-2977

Or you can fax us at: **1-919-552-5069**

Replacement parts and customer service is also available through our website.
Please visit us at **www.kingcanopy.com**