



Storage Garage 7.5 ft x 12 ft

7 ft 7 in Wide x 12 ft Deep x 6 ft 1 in Side Height /
7 ft 8 in Center Height



King Canopy Item # G0712

With 6 Legs, 1 Pc. Cover, 1 Zippered Front Wall,
Elastic Ball Straps, Foot Pads and Stakes.

These Tools Are
Recommended:



Distributed by:
PIC America, LTD.
1730 Five Points Lane • Fuquay-Varina, NC 27526
1-800-800-6296 • www.kingcanopy.com

WARNING:

Keep all flame and heat sources
away from this tent fabric. It is not
fire proof. The fabric will burn if
left in continuous contact with
any flame source.



PARTS LIST

5X9-15PC

(16) 69 Inch Pipe



3X0-15PC

(6) 36 Inch Pipe



3W16PC

(6) 3-Way Fittings



4W16PC

(3) 4-Way Fittings

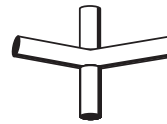

FOOT16PC-SL

(6) Metal Foot Pads

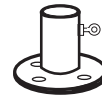

STAKE-GAR

(12) Foot Pad Stakes



T0712SF-GAR

(1) Cover with Rear Wall & Side Walls



T07SEWZF-GAR

(1) Zippered Front Wall

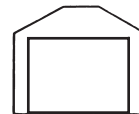

BALL

(35) Elastic Ball Straps



SC15

(4) Single Side Pipe Clamps



DC15

(2) Double Side Pipe Clamps

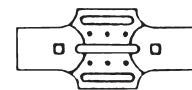

ROOF FRAME ASSEMBLY



- 1- Start assembly with top frame as shown in Diagram A. The 36 inch pipes are used for the roof rafters and 69 inch pipes form the length of frame. Start assembly with center peak as circled in Diagram A.

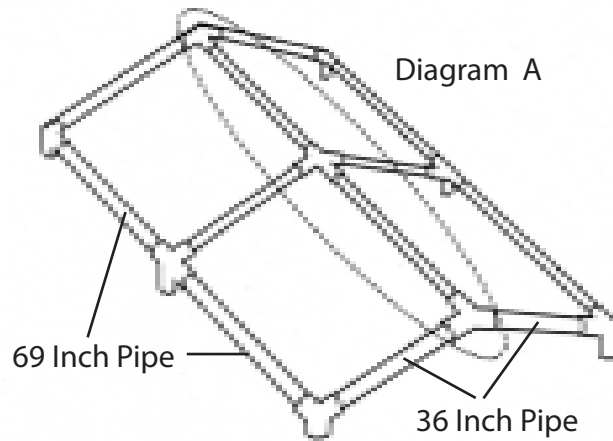

- 2- Once you have assembled the roof frame, insert the legs on one side using the 69 inch pipes with the foot pads installed.

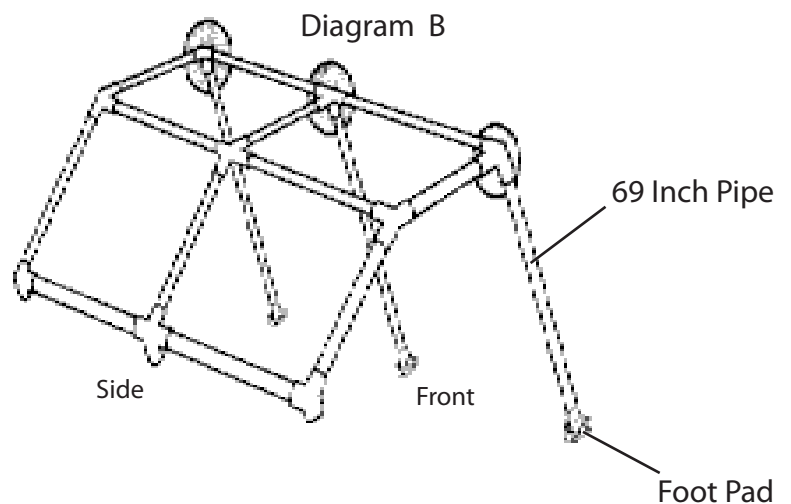

- 3- With the top frame laying over on one side and the legs inserted on the other side as seen in Diagram B, drape the one piece cover with sides and rear wall over the frame. Make sure you have the open end in the direction needed. Pull the one side down over the frame with the legs inserted. You can also pull the rear over the frame partially. Next, insert the legs on the opposite side and pull the remainder of the cover on.

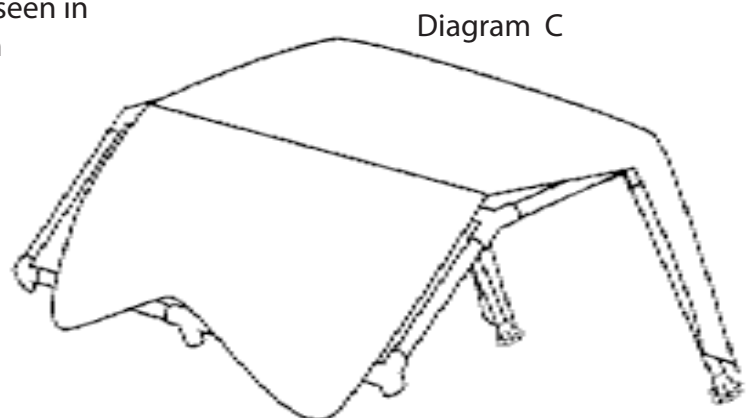



COVER ASSEMBLY

With frame assembled and cover on, you can now attach cover to frame using the ball straps. The grommet holes on the cover for attaching straps are located along the back and front frame line. Picture # 1 indicates where to find grommet holes. Attach the cover by running the strap through the grommet hole, around the pipe, then loop the strap over the ball. If the straps are too long for a tight fit, you can double wrap them or make an additional knot in the strap cord to shorten them.



PICTURE-1

To install side rails and wall support, slide a 69 inch pipe into the sleeves at the bottom of the side walls, as shown in picture # 2. Use double side clamp to connect to center leg and single side clamp to connect to corner legs. (See pictures below.)



Corner leg



Center leg



Corner leg



PICTURE-2

Your storage shelter can be used with or without the front zipped wall. If you choose to use your front wall, install it with the velcro strips and ball straps through the grommet holes, then attach it with velcro enclosures as seen in picture # 3. The wall can be removed quickly and easily at anytime. The front wall has a zippered door that rolls up to gain access and closes for storage. The sides and ends are extra long and can be buried in the ground or use rock, stone or brick over them to help keep unwanted creatures out. (See pictures below.)



PICTURE-3



ANCHORING YOUR UNIT



ANCHORS ARE NOT INCLUDED

This canopy is designed for use as a temporary structure. After assembly, the canopy **MUST BE** securely anchored to the ground to prevent damage from winds. Your canopy will act like a kite in the wind if not properly and securely anchored to the ground. Severe winds will cause the frame to twist and unanchored legs will fall, thereby collapsing the canopy. If severe winds are expected, you must remove the cover from the frame to prevent damage.

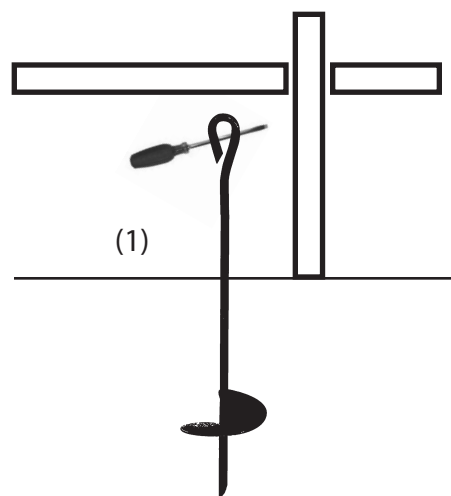

We recommend anchoring your canopy at each corner foot and center foot on each side. Screw anchor into ground next to canopy foot using a large screw driver (1). Tilting the anchor slightly will help the anchor to cut into the ground. Apply downward pressure while turning the anchor into the ground. Leave approximately three inches of anchor out of the ground.

Tie Rope (2) around the pipe, and then back through the anchor eye. Pull as tight as possible and secure. Anchor kits available online at www.kingcanopy.com or call customer service at 1-800-800-6296 and ask about purchasing our 6-piece anchor kit, item #A6200. **ANCHOR KIT SOLD SEPARATELY**

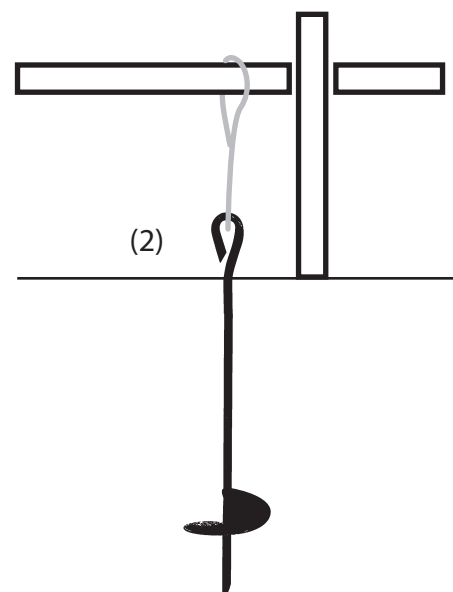



IMPORTANT NOTICE: PLEASE READ CAREFULLY

We are confident that you will be completely satisfied with your King Canopy unit. Please take a moment to read the very important information below, and call us with any questions you may have.

King Canopy/PIC America, LTD. has no control over wind, snow, ice, rain or any other weather condition and we are in no way responsible for any damage caused by the canopy or to the canopy. We suggest you contact your insurance carrier just as you would for any other outside structure.

OTHER PRECAUTIONS WHICH MUST BE FOLLOWED:

Keep all flame and heat sources away from this tent fabric. The tent fabric will burn if left in continuous contact with any flame source.

DO NOT cook underneath or near canopy.

DO NOT store or use flammable liquids underneath or near canopy.

DO NOT ignite or store fireworks underneath or near canopy.

DO NOT use bleach to clean cover.

DO NOT dry clean cover.

DO NOT wash cover in washing machine or dry in dryer. Hand wash with mild soap and water only.

DO NOT allow rain water, snow or ice to accumulate on top of cover.

DO NOT hang or suspend anything from the frame, grommets, truss system or ball straps of the unit.

REMOVE canopy cover before a storm, or disassemble entire canopy unit if possible.

REMOVE rain water, snow and ice from canopy cover.

This is a temporary structure and is not recommended for use as a permanent structure.

PRODUCT INFORMATION



Defective Parts

We try our best to eliminate any defective parts that are shipped with our products. If, however, you should find a defective part, we will replace – free of charge – any part which is defective. You will need to provide proof of purchase showing date of purchase and provide us with detailed description of the defective component. Your replacement will be shipped by ground shipping, freight prepaid. Next day or express shipping will require freight collect and paid for by you, the consumer. Damages from improper anchoring, strong winds, snow, ice or rain are not considered defects.

Improper Anchoring, Strong Winds, Rain Snow, or Ice

King Canopy/PIC America, LTD. does not guarantee these canopies under strong weather conditions. These canopies are designed to protect against damages caused by sun, rain, tree sap, birds, etc. They are not designed to hold roof loads that accompany snow, ice or heavy rains. If your canopy is not anchored securely, it can be lifted by the wind and will fly away. If your canopy takes flight, we are not responsible for any replacement. If you know strong weather is predicted, remove the cover or take down the canopy unit completely. The cover is designed to be quickly and easily removed.

Warranty

All components of this canopy feature a 1-year limited warranty and are warranted to be free from defects in material and workmanship for a period of 1-year. You must complete and return the enclosed warranty card promptly after purchase. Please retain your proof of purchase receipt; you will be asked to provide this receipt in order to obtain warranty service.

Non-Warranty Replacement Parts

If after expiration of the warranty period, you require replacement parts please contact us at 1-800-800-6296. We stock replacement parts and make them available to you at discounted prices. Our customer service department will be pleased to assist you in any way possible.

Certain regions of the country are extremely hard on covers of any kind. Normal wear and tear is not covered under the warranty, and should be expected.

In order to receive a discounted or free replacement part, you may be asked to return the part, freight prepaid, to our warehouse for inspection before we will send a replacement. You must, in all cases, provide a copy of your receipt showing the date of purchase, model number and price.

For missing parts, replacement parts or any questions:

Please Call 8:00am – 5:00pm EST, Monday – Friday
1-800-800-6296 or 1-919-552-2977

Or you can fax us at: **1-919-552-5069**

Replacement parts and customer service is also available through our website.
Please visit us at **www.kingcanopy.com**