

# ASSEMBLY INSTRUCTION

- A M3. 5\*45 16PCS+1
- B M3. 5\*35 16PCS+1
- C M3. 5\*30 32PCS+1
- D M3. 5\*25 16PCS+1
- E M3. 0\*16 12PCS+1
- F M6\*55 8PCS
- H M3. 5\*60 4PCS+1
- G \*1

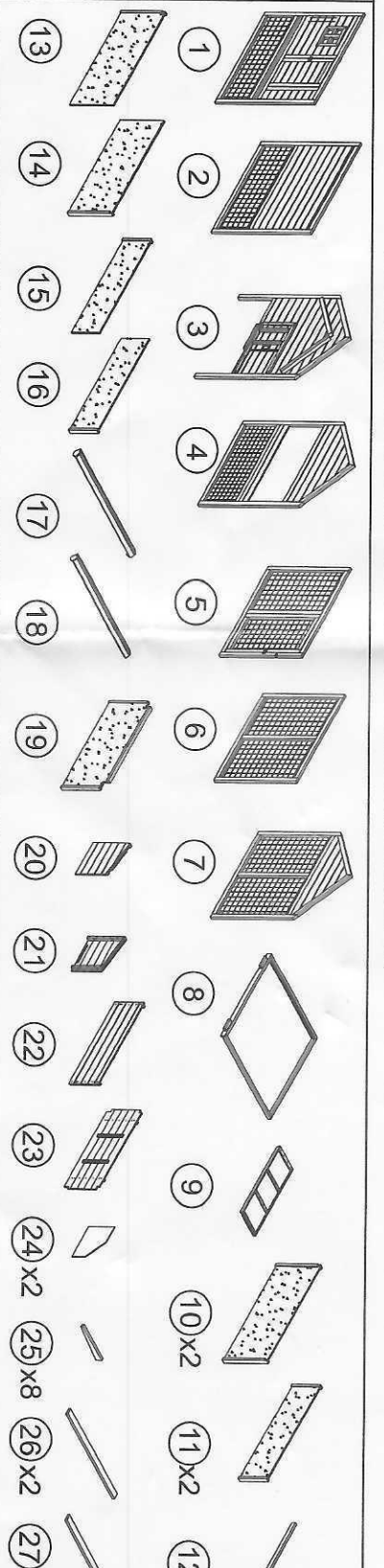

A M3. 5\*45 12PCS  
E M3. 0\*16 4PCS

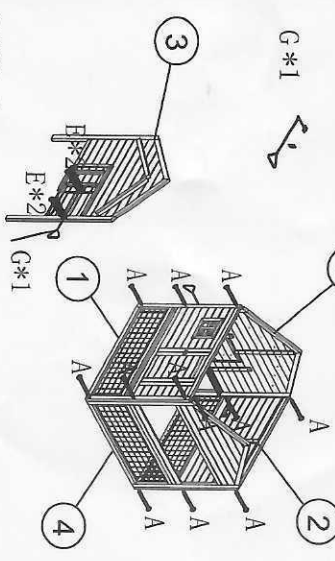

E M3. 5\*16 2PCS

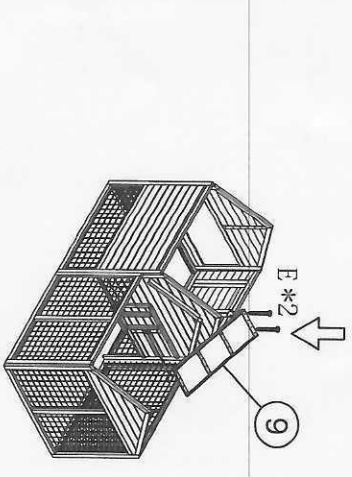

STEP 4

A M3. 5\*45 4PCS  
H M3. 5\*60 4PCS

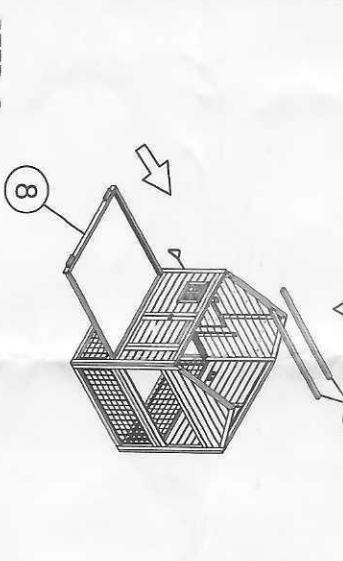

F M6\*55 8PCS

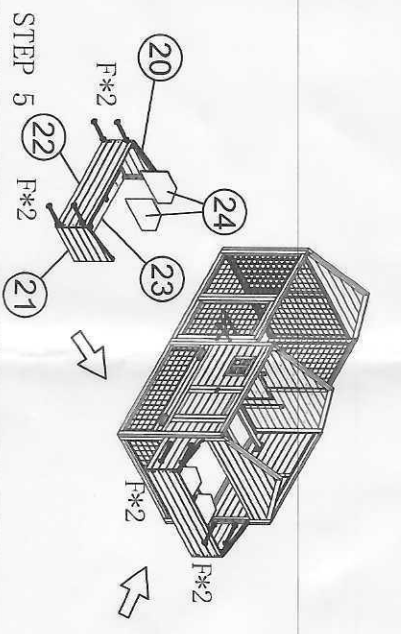

STEP 5

A M3. 5\*45 4PCS  
H M3. 5\*60 4PCS

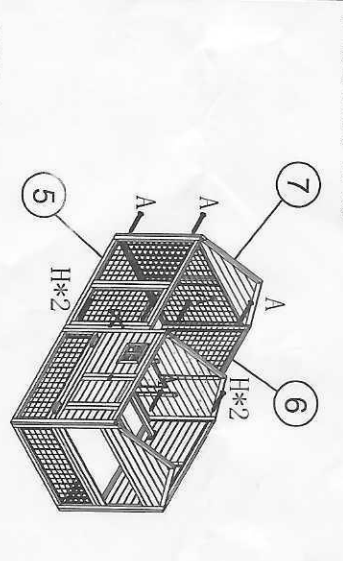

B M3. 5\*35 8PCS  
D M3. 5\*25 4PCS

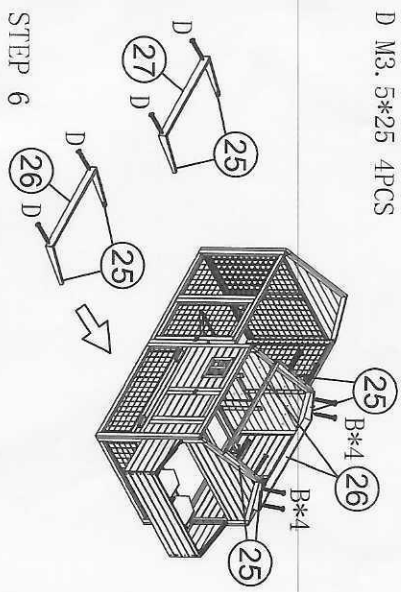

STEP 6

# ASSEMBLY INSTRUCTION

B M3. 5\*35 8PCS  
D M3. 5\*25 4PCS

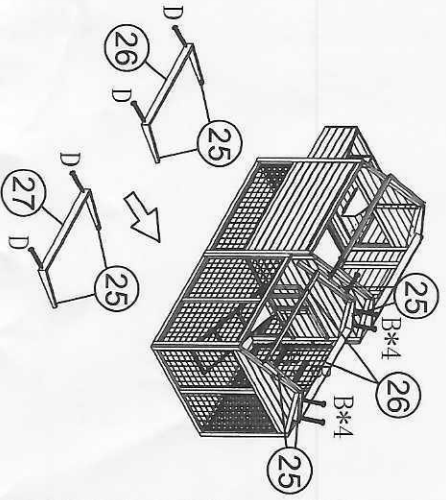

STEP 7

C M3. 5\*30 8PCS

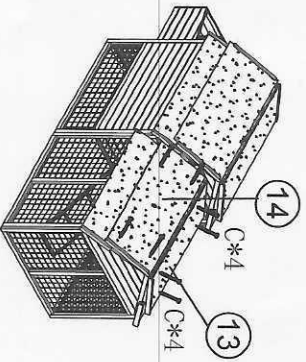

STEP 11

C M3. 5\*30 8PCS

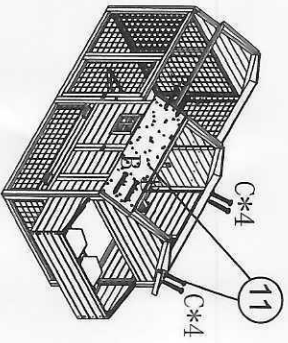

STEP 8

D M3. 5\*25 8PCS

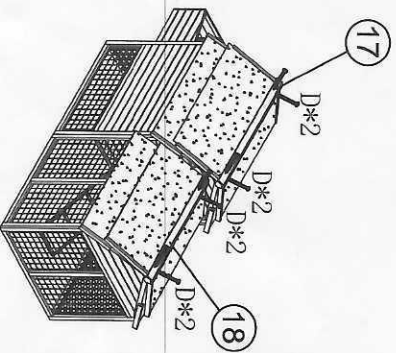

STEP 12

C M3. 5\*30 8PCS

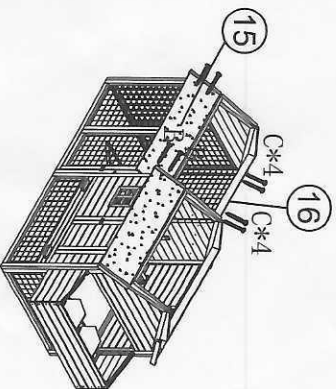

STEP 9

E M3. 0\*16 6PCS

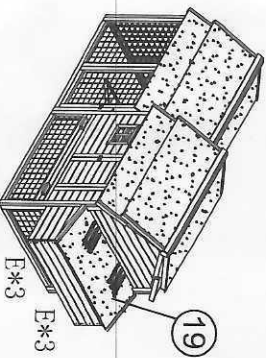

STEP 13

C M3. 5\*30 8PCS

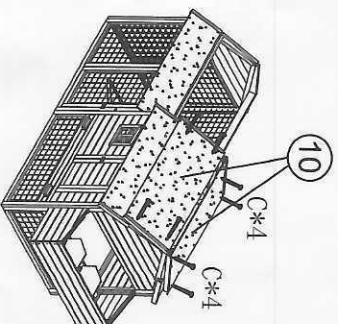

STEP 10

STEP 14

