



ORNAMENTAL STEEL FENCING

NO LIMITS. KNOW BOUNDARIES.



JOIN THE REVOLUTION.
FortressBP.com | 866.323.4766





FENCING THAT'S AHEAD OF THE CURVE

Our VERSAI™ ornamental steel fencing line is easily rackable to suit grade changes in aggressive landscapes. While the rigidity of a traditional welded fence requires stair-stepping of panels on hills and slopes, a rackable fence adjusts to follow the curve of the landscape.

**RACKABLE TO
MATCH
TERRAIN**

**NO VISIBLE
FASTENERS**

**NO
METAL ON
METAL
CONNECTION
POINTS**



KEY FEATURES

- Easy rackability adjusts to grade changes in the landscape
- Patented pin-hinge technology eliminates metal on metal which can cause fatigue and rust
- Rackable design easily adjusts 48" on an 8' panel to match terrain
- Patented* hidden pin-hinge system means no visible fasteners
- Available styles include flat top / flat bottom flat top, extended picket, pressed spear, extended picket / flat bottom, pressed spear / flat bottom and pool panels
- Add style with finials, knuckles, rings and ball caps
- Perfectly smooth rail as a result of the pin-hinge technology
- Virtually maintenance-free, thanks to the E-coat and architectural grade powder coat
- Simple bracket design speeds installation, which reduces labor cost
- True 5/8" picket size, no scant sizing like our competitors
- Optional Assurance panels feature a 3" air space for increased safety where young children or pets play
- Peace of mind with a FortressShield 20-year warranty
- *US Patent No. 8899555
Canadian Patent No. 2698715
Australian Patent No. 2008296065
European Patent No. 08799266.5

COLOR OPTIONS



Gloss Black



Black Sand

WARRANTY

20-Year Limited Warranty

VERSAI is supported by G60 galvanized steel, nano ceramic pretreatment, E-coat and architectural grade powder coat to weather the elements without sacrificing quality. UV inhibitors reduce fading and provide years of protection.



PANEL & GATE STYLES

Patented Pin-Hinge System

- Rigid projection welded construction
- Adjusts to the most aggressive landscapes
- No metal on metal when raking – fatigue and rust can be initiated with metal on metal rackability

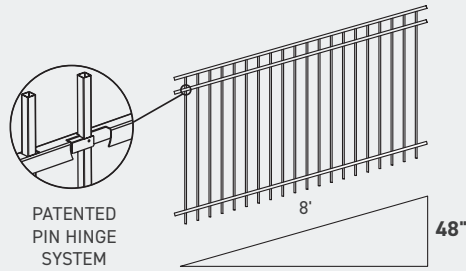

US Patent No. 8899555
 Canadian Patent No. 2698715
 Australian Patent No. 2008296065
 European Patent No. 08799266.5

Flat Top

Rail: 1" X 1-3/16" 16 Gauge | Picket: 5/8" 18 Gauge | Gate Uprights: 1-1/2" 16 Gauge | Air space: 3-7/8"

Three Rail Panels

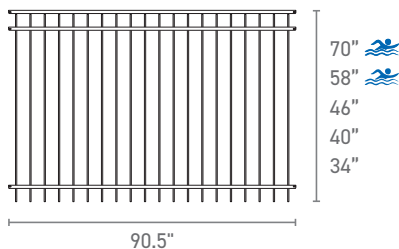

Two Rail Panels

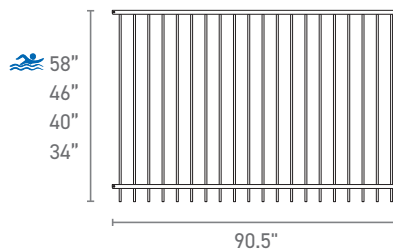

Three Rail Gates

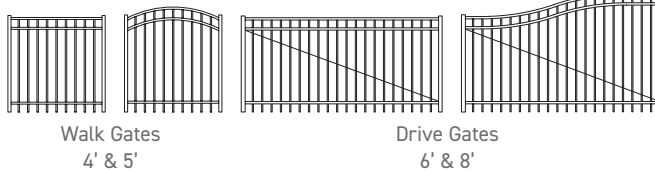

Two Rail Gates

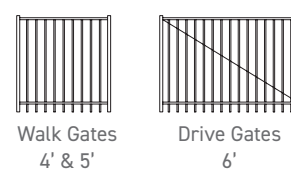

Flat Top / Flat Bottom

Rail: 1" X 1-3/16" 16 Gauge | Picket: 5/8" 18 Gauge | Gate Uprights: 1-1/2" 16 Gauge | Air space: 3-7/8"

Three Rail Panels

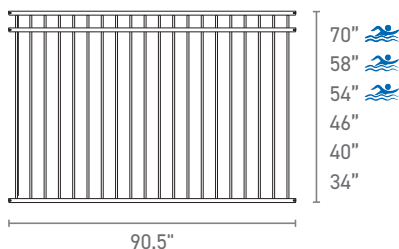

Two Rail Panels

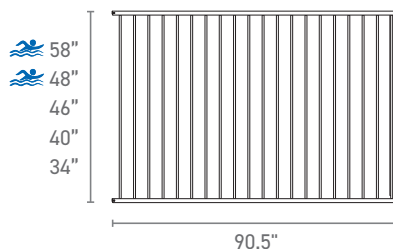

Three Rail Gates

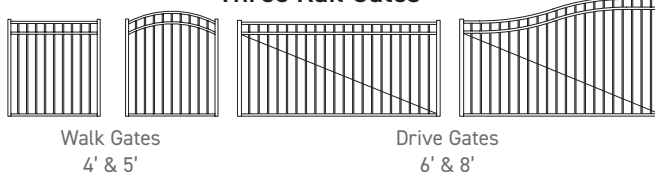

Two Rail Gates

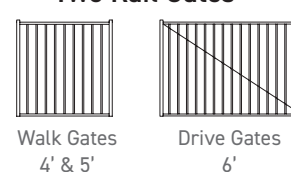

PANEL & GATE STYLES

Pressed Spear

Rail: 1" X 1-3/16" 16 Gauge | Picket: 5/8" 18 Gauge | Gate Uprights: 1-1/2" 16 Gauge | Air space: 3-7/8"

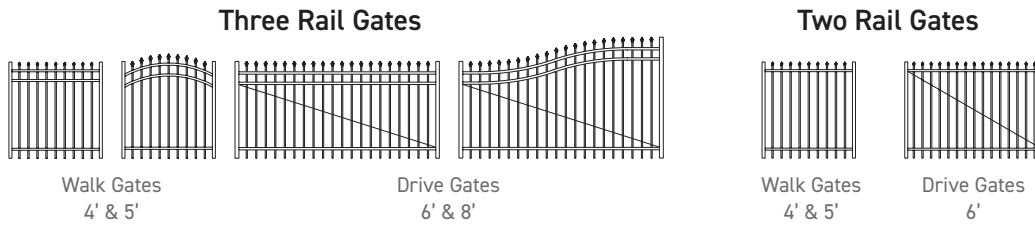
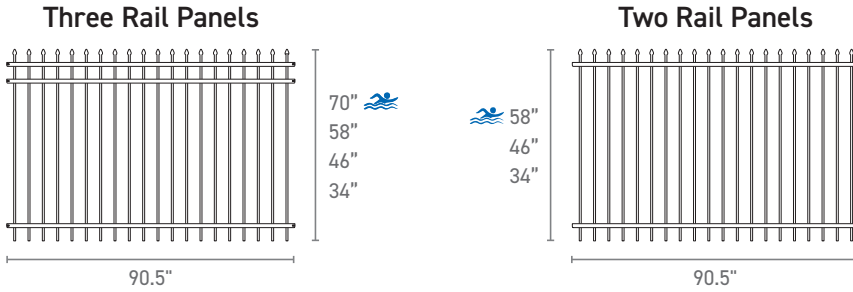

Pressed Spear / Flat Bottom

Rail: 1" X 1-3/16" 16 Gauge | Picket: 5/8" 18 Gauge | Gate Uprights: 1-1/2" 16 Gauge | Air space: 3-7/8"

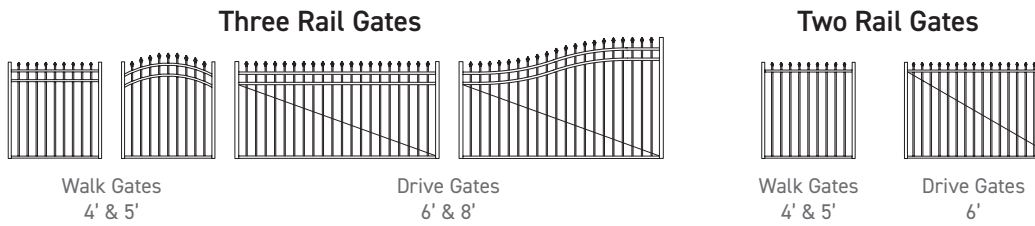
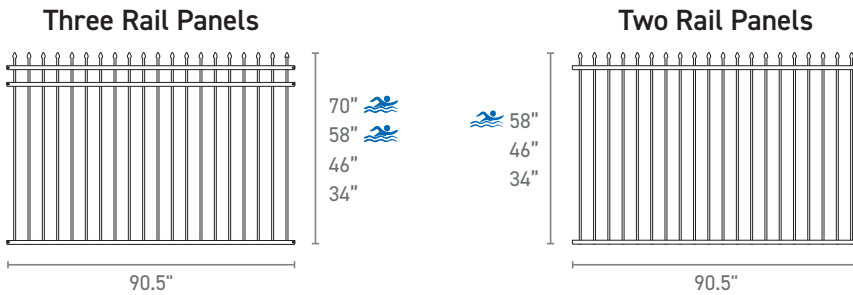

PANEL & GATE STYLES

Extended Picket

Rail: 1" X 1-3/16" 16 Gauge | Picket: 5/8" 18 Gauge | Gate Uprights: 1-1/2" 16 Gauge | Air space: 3-7/8"

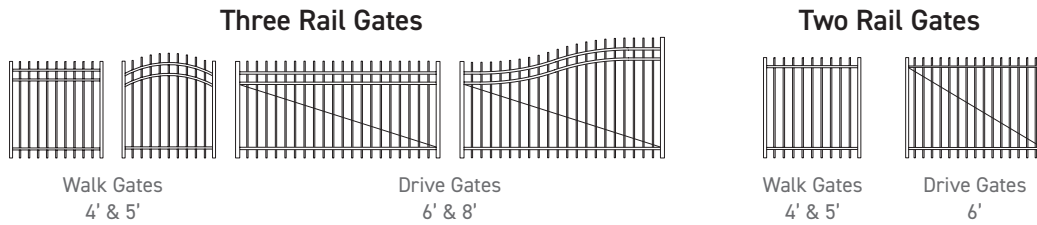
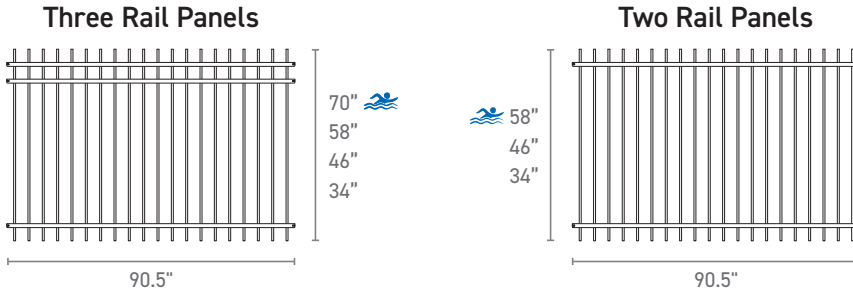

Extended Picket / Flat Bottom

Rail: 1" X 1-3/16" 16 Gauge | Picket: 5/8" 18 Gauge | Gate Uprights: 1-1/2" 16 Gauge | Air space: 3-7/8"

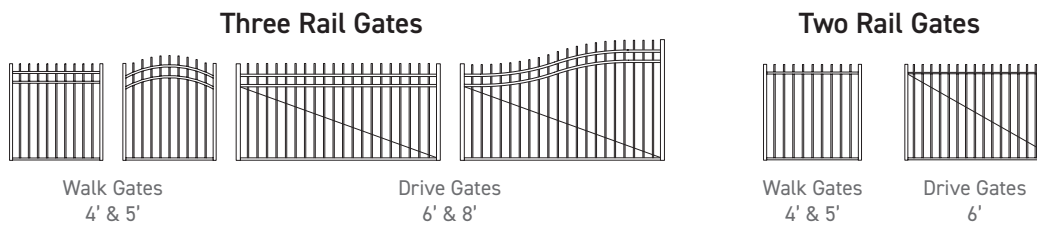
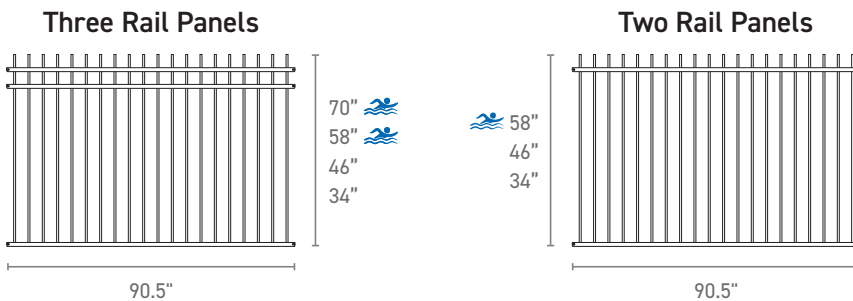

HARDWARE & ACCESSORIES

Brackets

Accommodates 92-5/8" to 93-3/8" OC spacing



EXT. ONE DIR.
(EX-104)

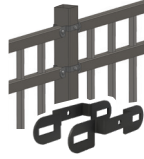

EXT. TWO DIR.
(EXW-204)



EXT. THREE DIR.
(EXW-304)



SWIVEL
(EXS-104)



OMNI

Accommodates 94-7/8" to 96" OC spacing



EXT. ONE DIR.
(EX-104 96" OC)



EXT. THREE DIR.
(EXW-304 96" OC)

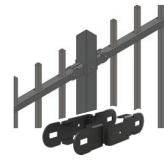

EXT. TWO DIR.
(EXW-204 96" OC)

Posts + Post Accessories

With Base		Without Base	
2"		2"	
52"		72"	
58"		84"	
64"		96"	
74"		108"	

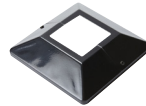

Base Plate
Cover

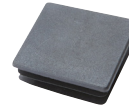

Nylon
Cap



Pressed
Dome Cap



Ball Cap

Gate Kit

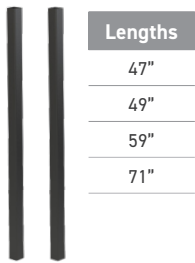

1.5"x1.5" Gate Uprights

Lengths

- 47"
- 49"
- 59"
- 71"



Pressed
Dome Cap



Gate Ell



Assembled
Gate Ell Kit

Accessories



Fleur De Lis



Triad



Quad



Rings

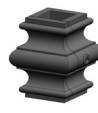

2pc
Knuckle



Readysset
Cement
& Grout

HARDWARE & ACCESSORIES

Residential Gate Hardware



Hinge



Fork Latch



Gravity Latch



Pro Series Drop Rod

ASSURANCE (3" AIR SPACE)

Fortress® ASSURANCE Panels and Gates are perfect for playgrounds, small pets, and pools. ASSURANCE is available in VERSAI Residential and Commercial Products. With its 3" air space, rest assured that it'll protect those most precious to you.



CUSTOM FABRICATION

Fortress Building Products is proud to offer a full range of custom fabricated gates and panels to meet any project needs. With its own custom fabrication facility, there is a dedicated staff to help design any gate or panel to individual specification and style. Fortress Custom Fabrication is also available in a broad range of premium finishes. Carrying up to a 5-year limited manufacturer warranty, Fortress Custom Fabrication manufactures to a standard of pre-galvanized and premium powder coated steel to provide gates and panels that will withstand the elements. For assistance with developing custom gates or panels, and information about custom colors and pricing, please contact us at 1-844-909-1999 or specifications@fortressbp.com.

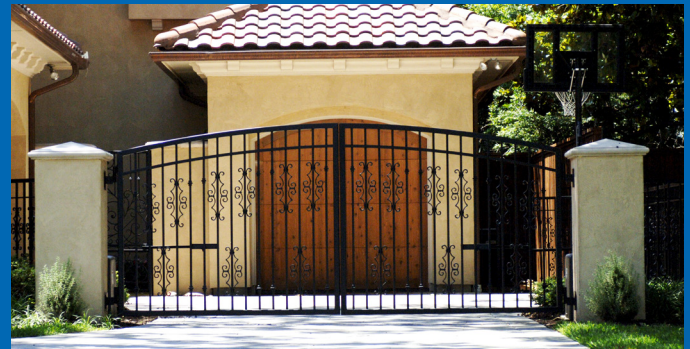

SPECIFY FORTRESS

Fortress Building Products is the leading manufacturer of perimeter fencing. We are committed to developing innovative, quality products specifically for the ornamental fence industry. For any drawings or specification related to one of our products, please contact our Commercial Estimating Department at 1-844-909-1999 or specifications@fortressbp.com. We invite you to visit FortressBP.com, ARCAT.com and CADdetails.com.



PROUD AFFILIATES

Fortress Building Products actively supports multiple industry trade and technical standards organizations through service in trade shows, membership activities, continuing education seminars and active roles in leadership committees. Fortress is proud to invest time and finances into these organizations in our commitment to supporting and growing key segments of the fence industry.





JOIN THE REVOLUTION.

FortressBP.com | 866.323.4766

RESIDENTIAL | COMMERCIAL | INDUSTRIAL

Looking for a smarter solution for your perimeter fencing? Go with the leading manufacturer who continues to push the industry. Fortress Building Products is committed to developing extraordinary products that are never a barrier to innovation.