



TB-3048SS

12 cu ft STEELSWIVEL DUMP CART

U.S. Patent No. 8,496,298



READ AND FOLLOW ALL SAFETY RULES AND OPERATING
INSTRUCTIONS BEFORE USING THIS EQUIPMENT

Carton Contents

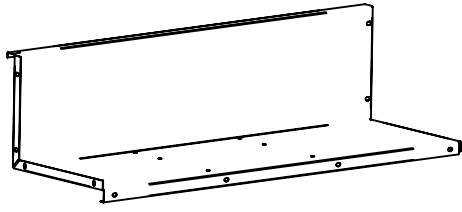

1 (x1)

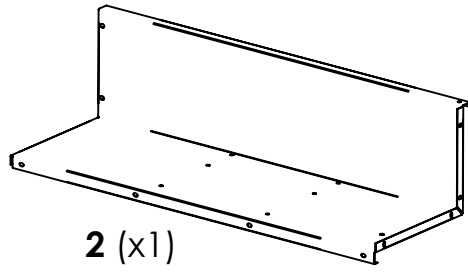

2 (x1)

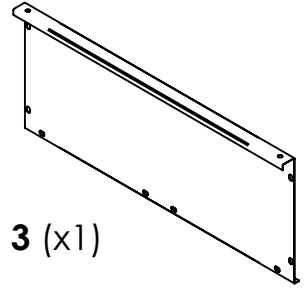

3 (x1)

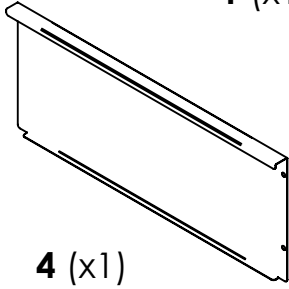

4 (x1)

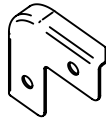

5 (x2)



6 (x1)



7 (x1)

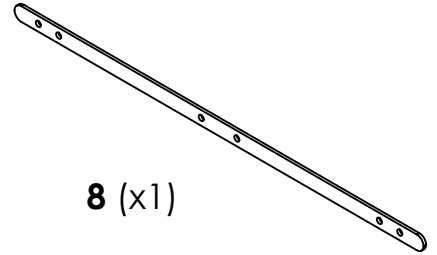

8 (x1)

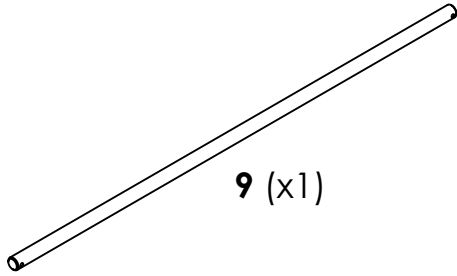

9 (x1)

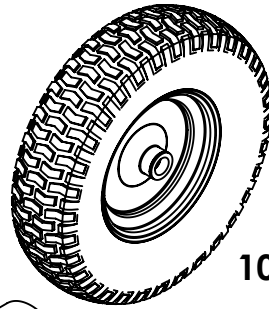

10 (x2)

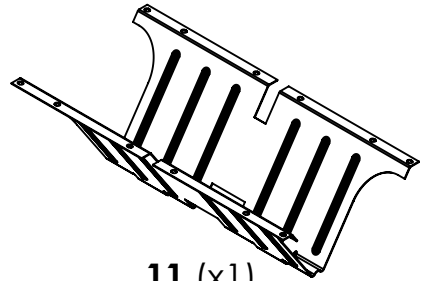

11 (x1)

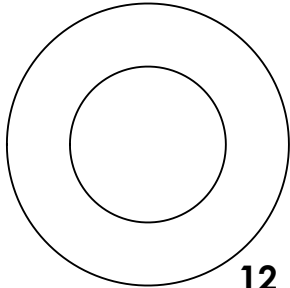

12 (x4)

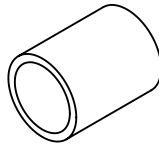

13 (x2)

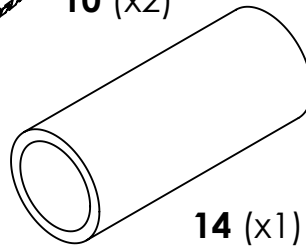

14 (x1)

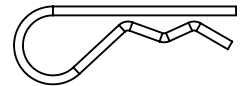

15 (x2)

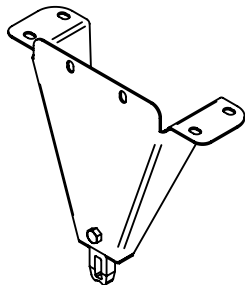

16 (x1)

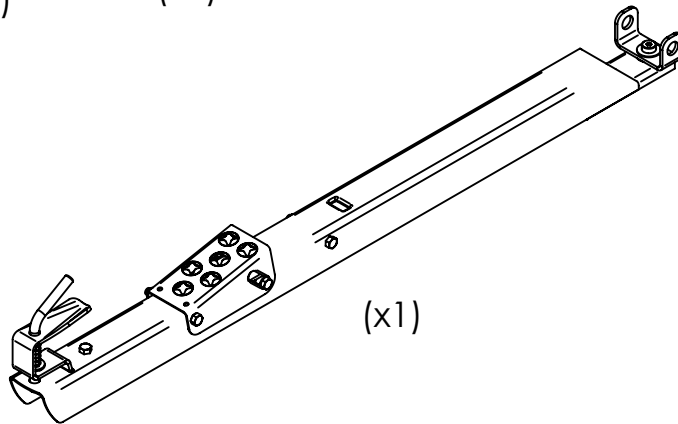

(x1)



32 (x46)

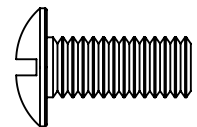

33 (x46)

TOOLS REQUIRED FOR ASSEMBLY:

- 1/2" Wrench or Socket
- Large Flat Screwdriver

Repair Parts

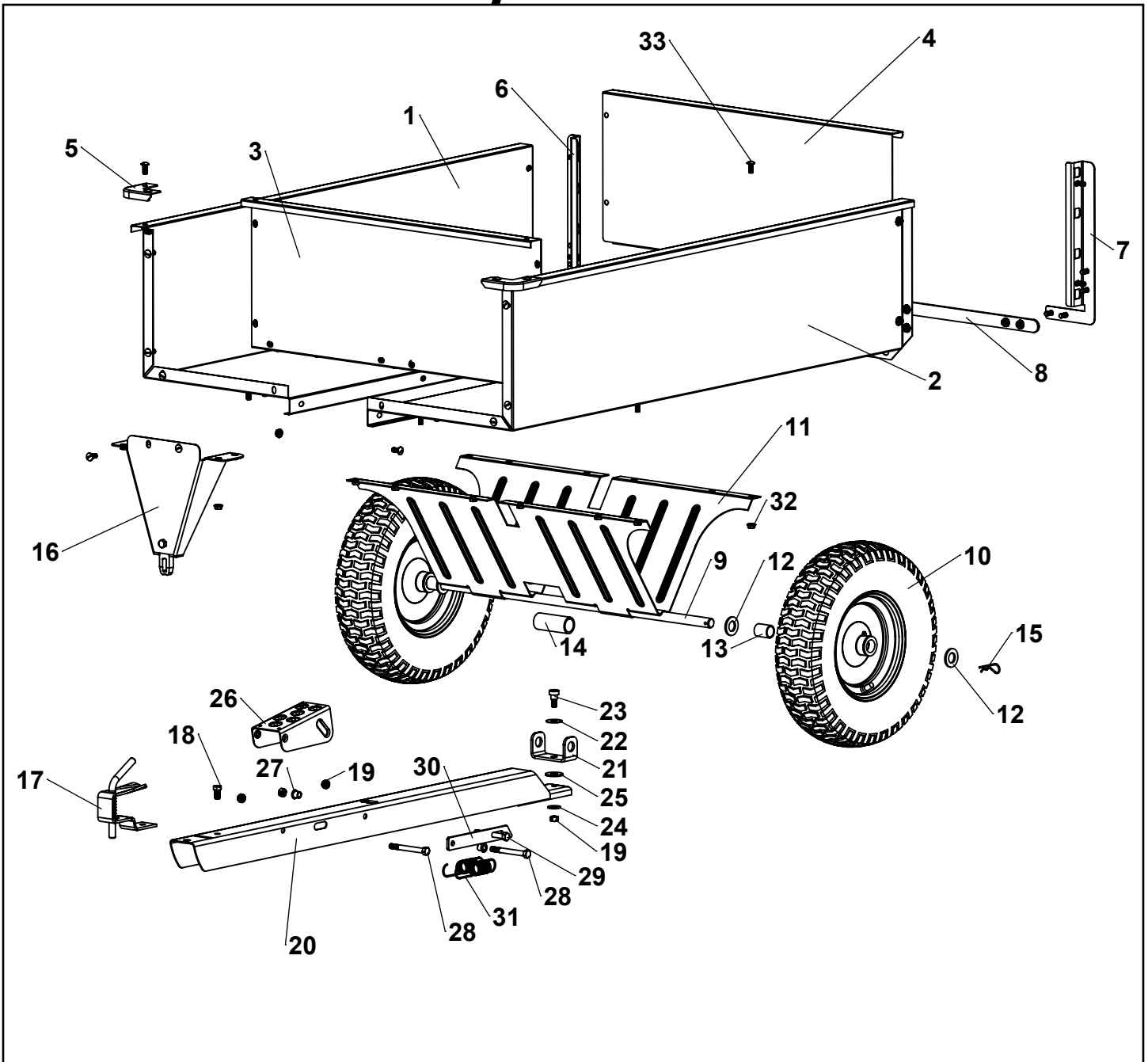

ITEM	PART NO	DESCRIPTION	QTY	ITEM	PART NO	DESCRIPTION	QTY
1	401011-R2	BODY HALF, RIGHT	1	17		SPRING LOADED HITCH BRACKET	1
2	401021-R2	BODY HALF, LEFT	1	18		HEX BOLT, 3/8-16 X 3/4"	2
3	401031-R2	GATE, FRONT	1	19		HEX NUT, 3/8-16 C-LOCK	6
4	401041-R2	TAILGATE	1	20		DRAWBAR, WELDED	1
5	401051-R2	CORNER	2	21		CLEVIS, SWIVEL	1
6	401071-R2	RETAINER GATE, RIGHT	1	22		WASHER, SPRING	1
7	401081-R2	RETAINER GATE, LEFT	1	23		SHOULDER BOLT, 1/2" X 3/8"	1
8	401131-R2	BAR SUPPORT, REAR	1	24		WASHER, 3/8" USS	1
9	300001	AXLE	1	25		WASHER, 1/2" USS	1
10	6002415	WHEEL	2	26		FOOT PEDAL	1
11	401061-B2	UNDERCARRIAGE	1	27		BEARING	2
12	3000721-ZB	WASHER, 3/4" SAE	4	28		HEX BOLT, 3/8-16 X 3-1/2"	2
13	6000105	SPACER, SHORT	2	29		HEX BOLT, 3/8-16 X 3"	1
14	6000463	SPACER, LONG	1	30		LATCH	1
15	300084	HAIRPIN COTTER, 0.093" X 2-5/16"	2	31		SPRING, LATCH	2
16	6000310-B2	FRONT SUPPORT	1	32		SPINNER GRIP NUT, 5/16-18	46
				33		SLOTTED BOLT, 5/16-18 X 3/4"	46