

A

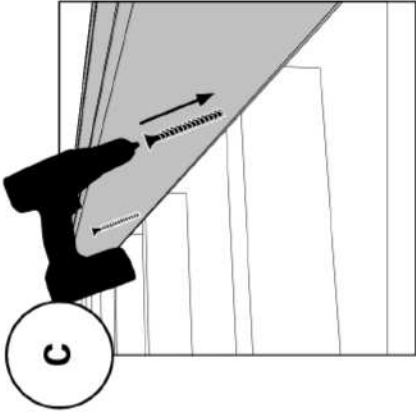

C

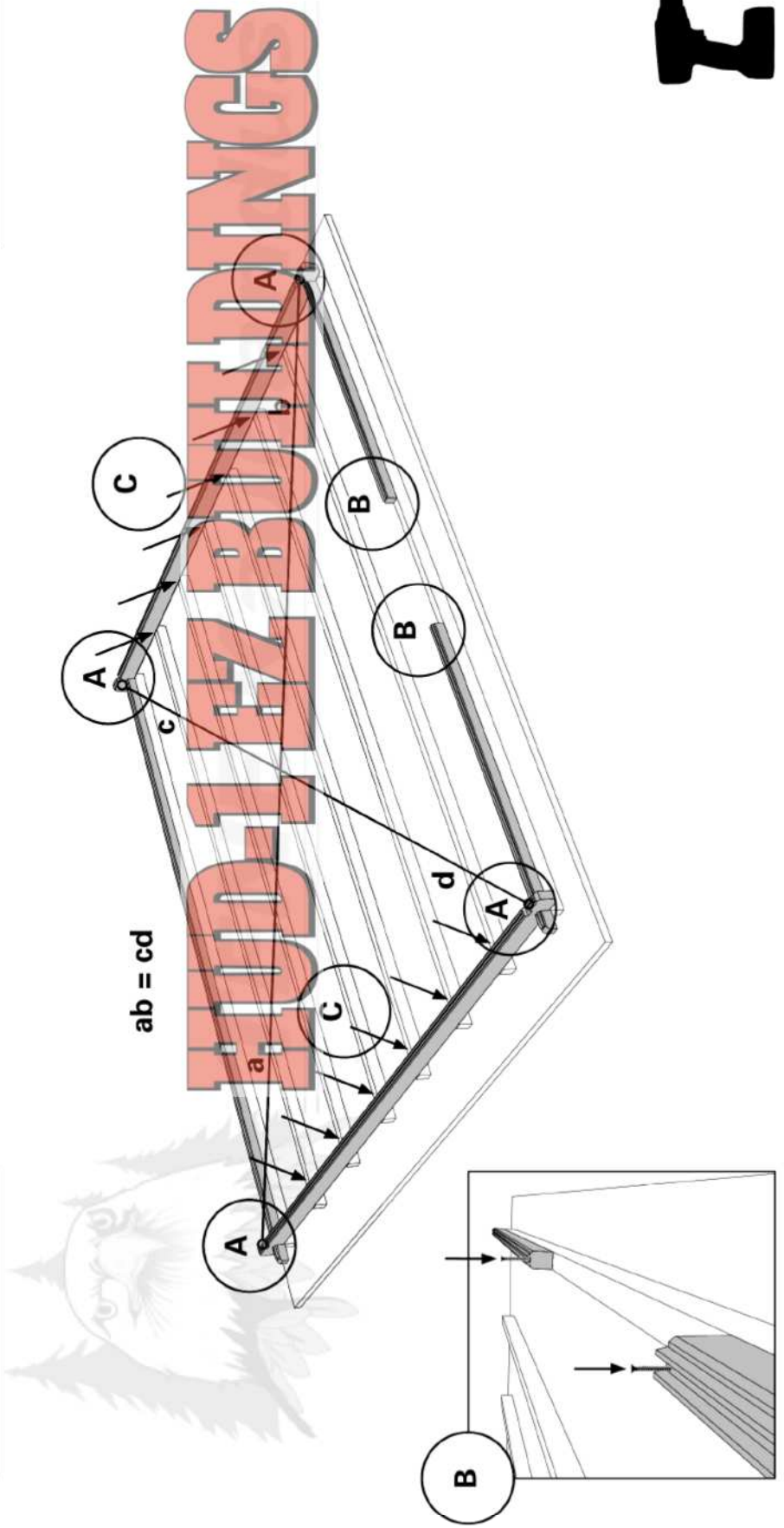

$ab = cd$



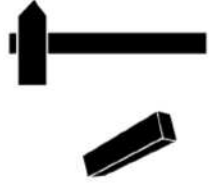
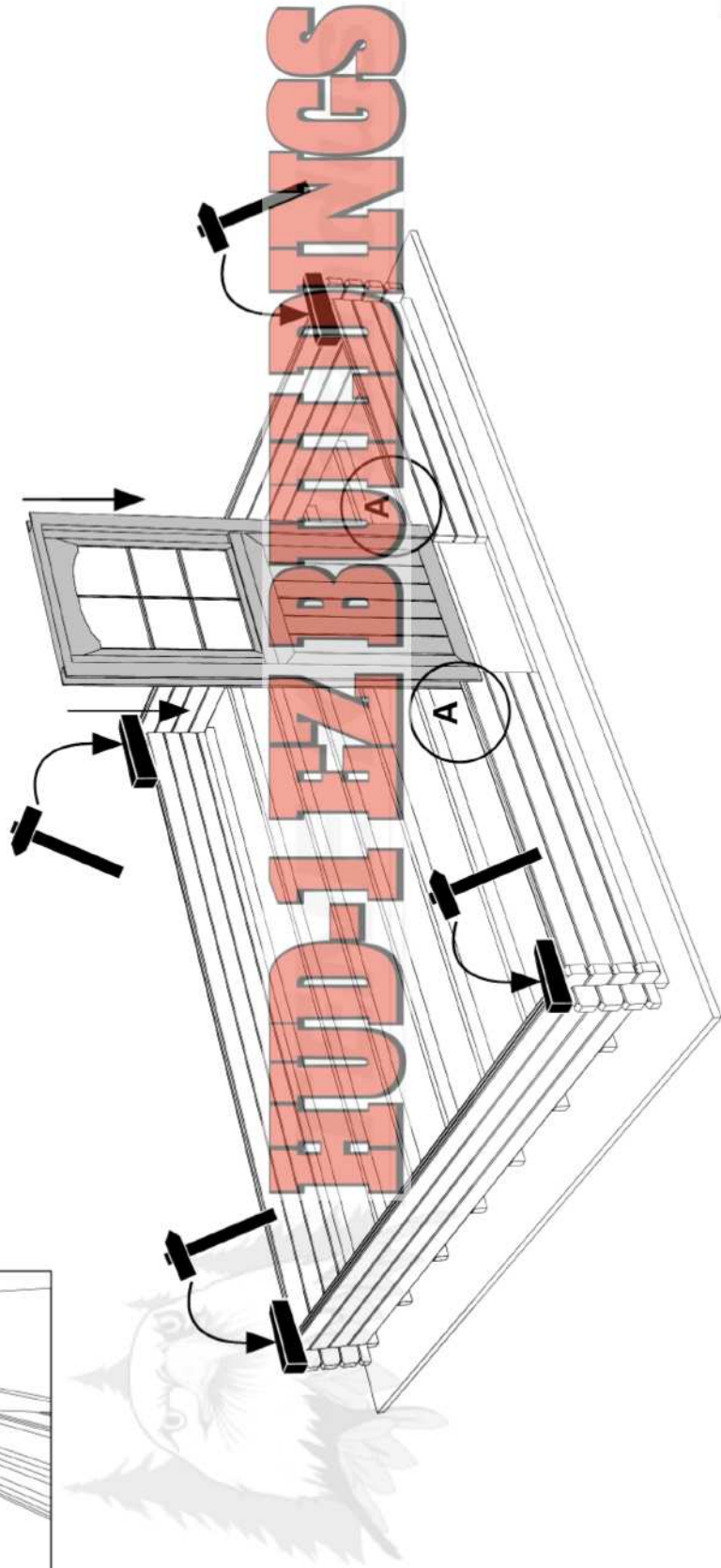
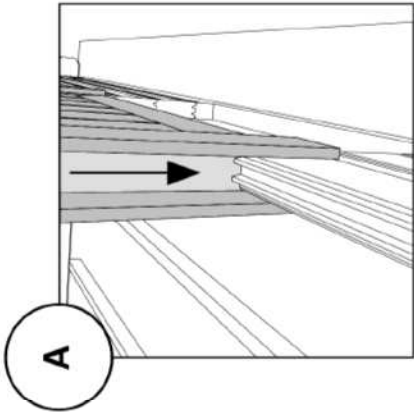



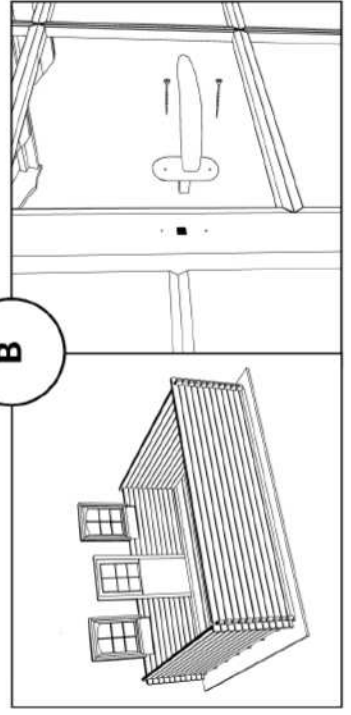
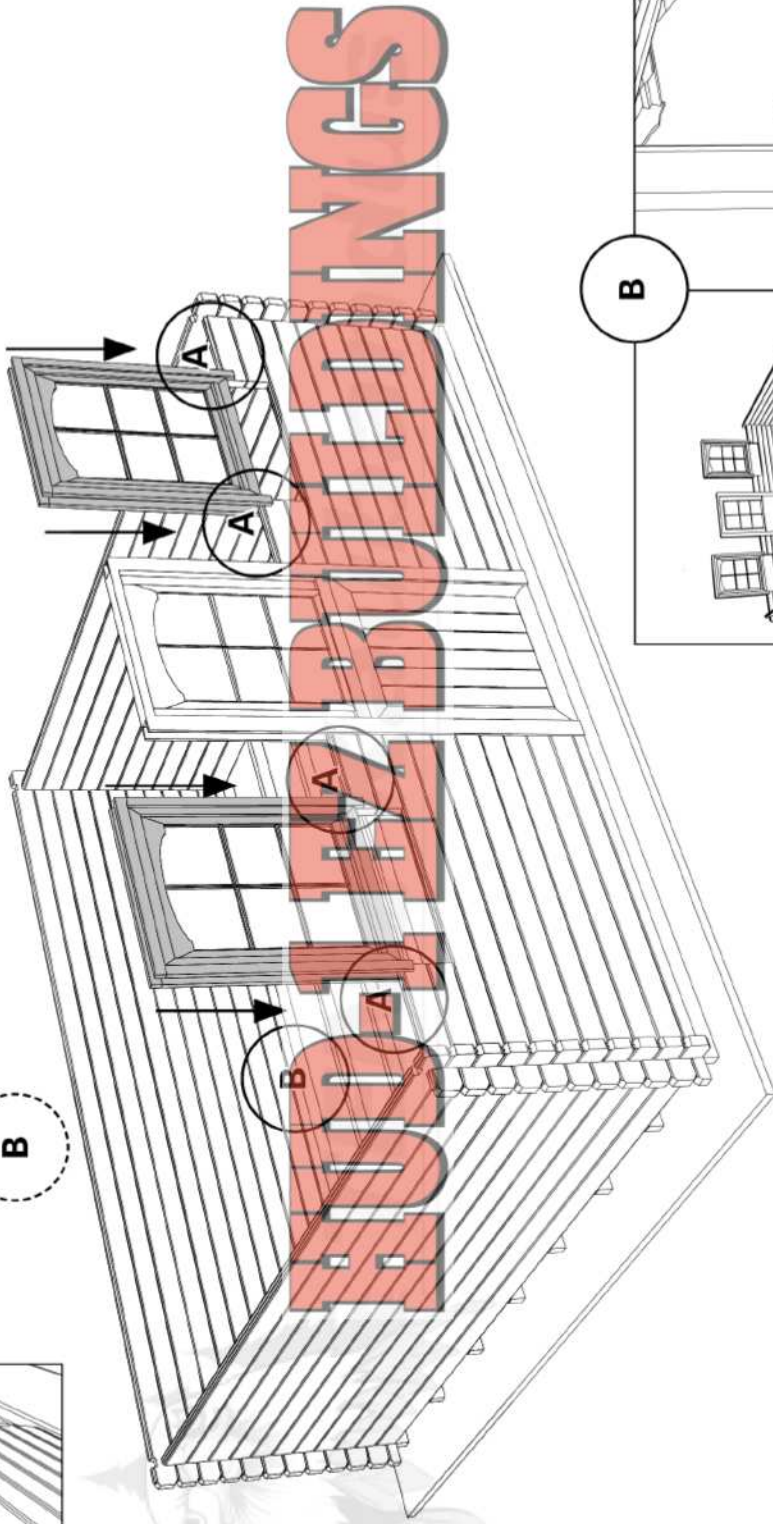
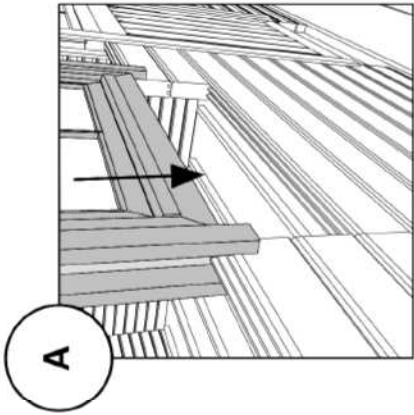

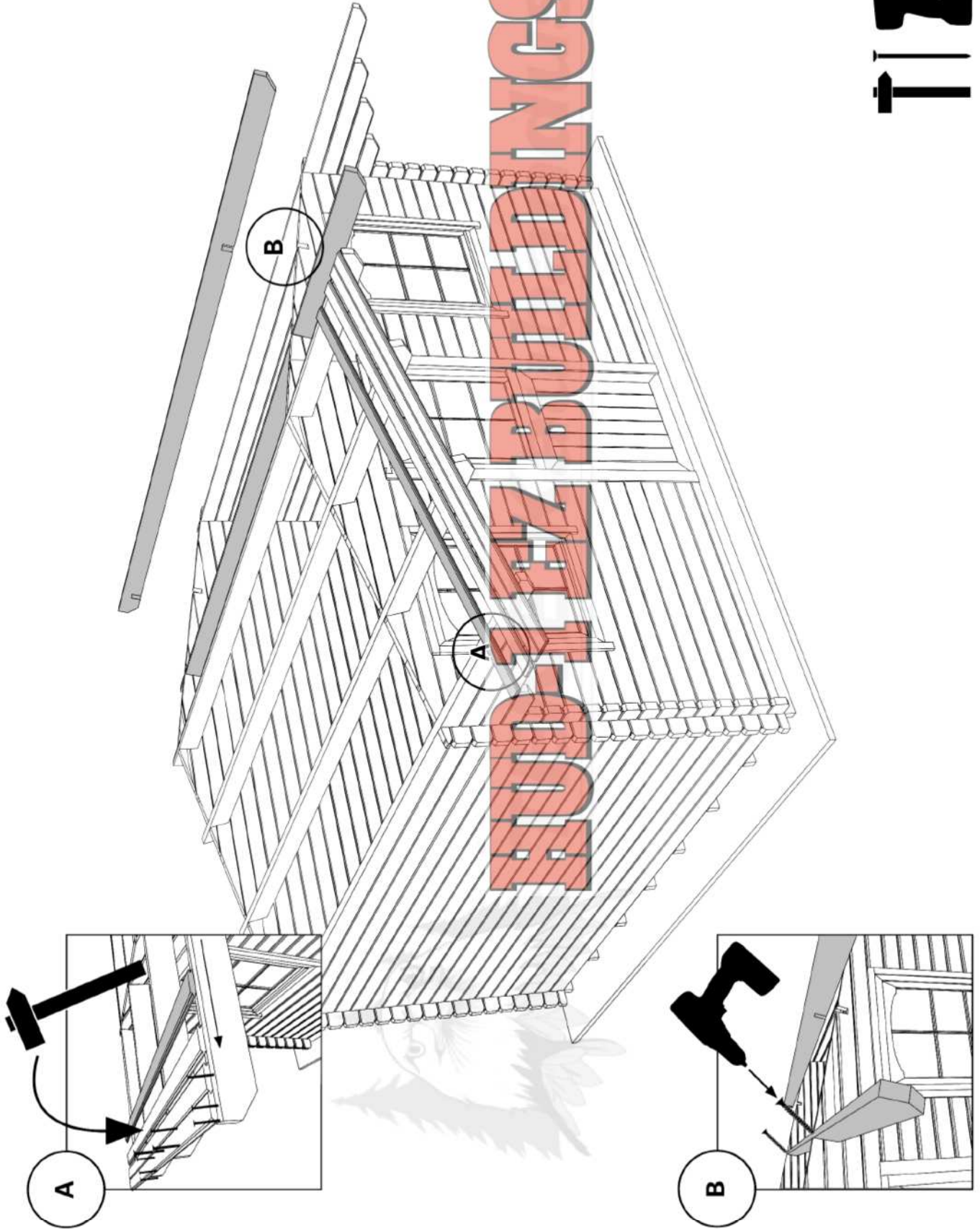



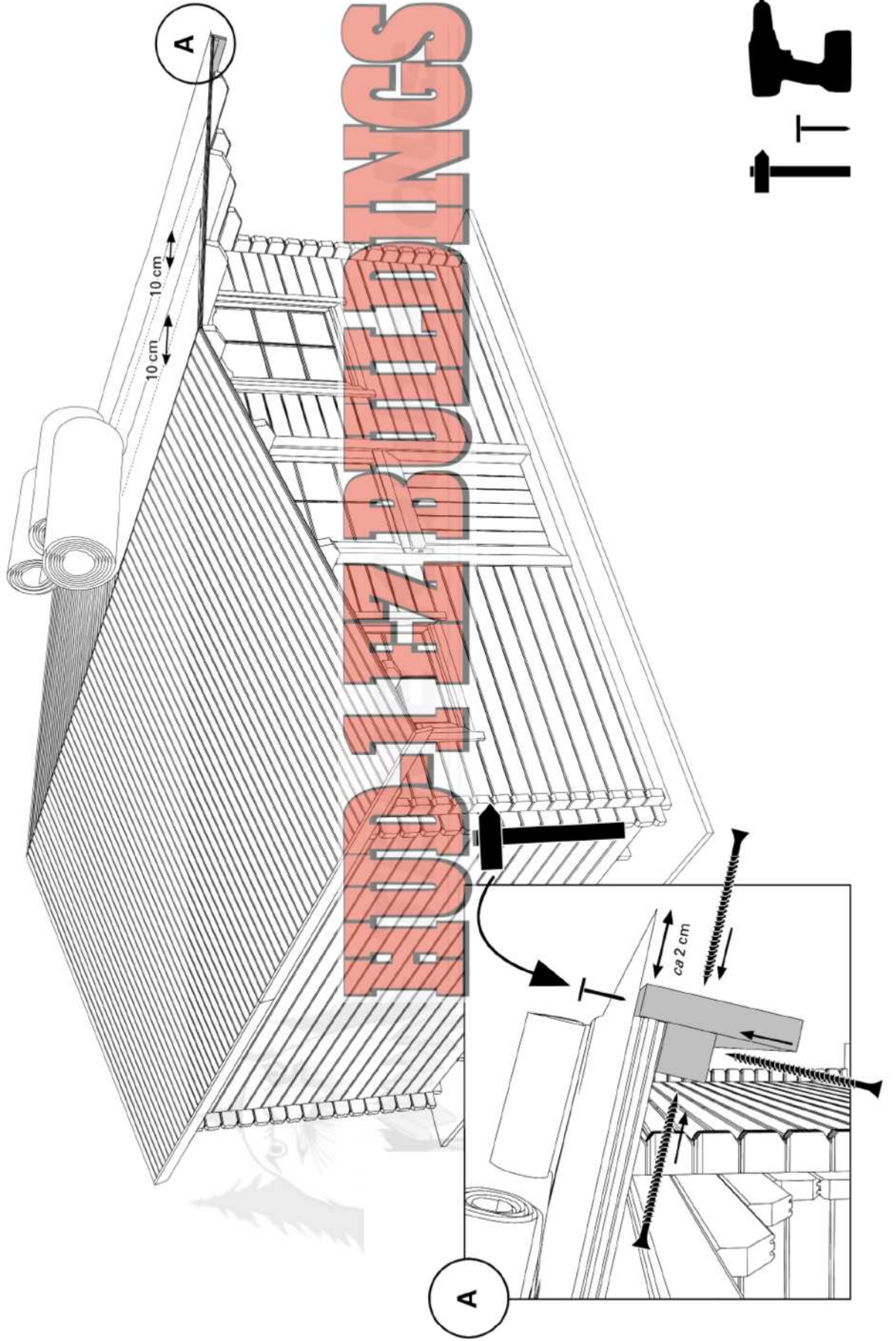

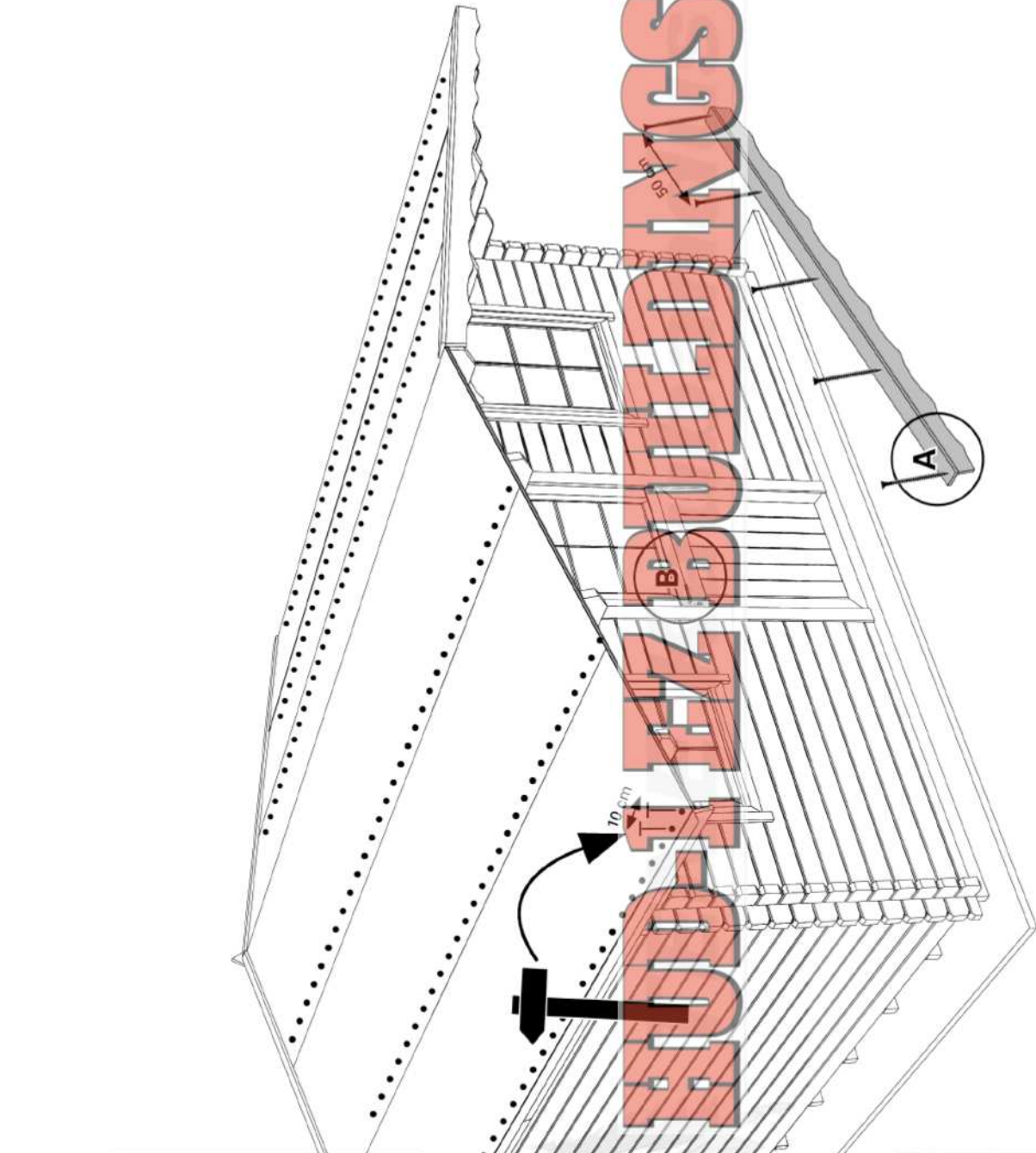
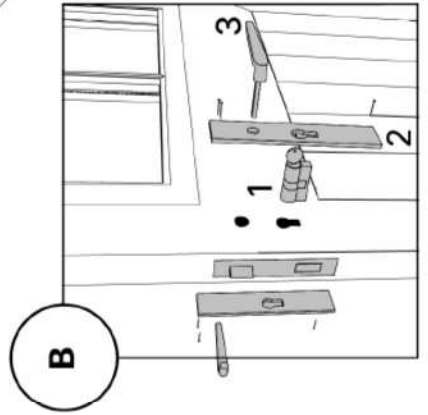
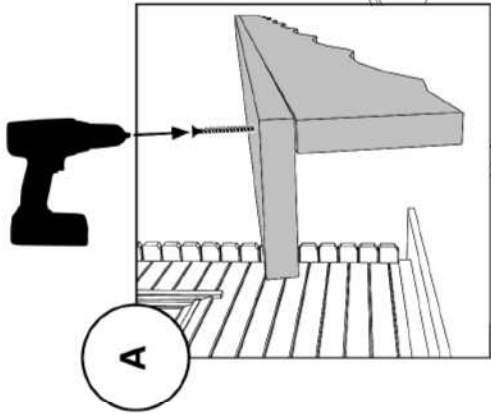



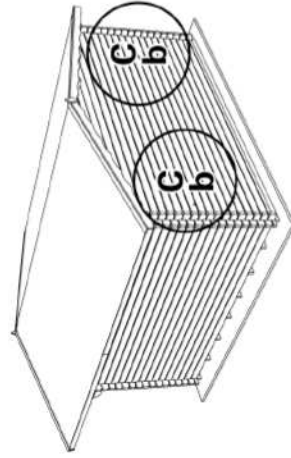
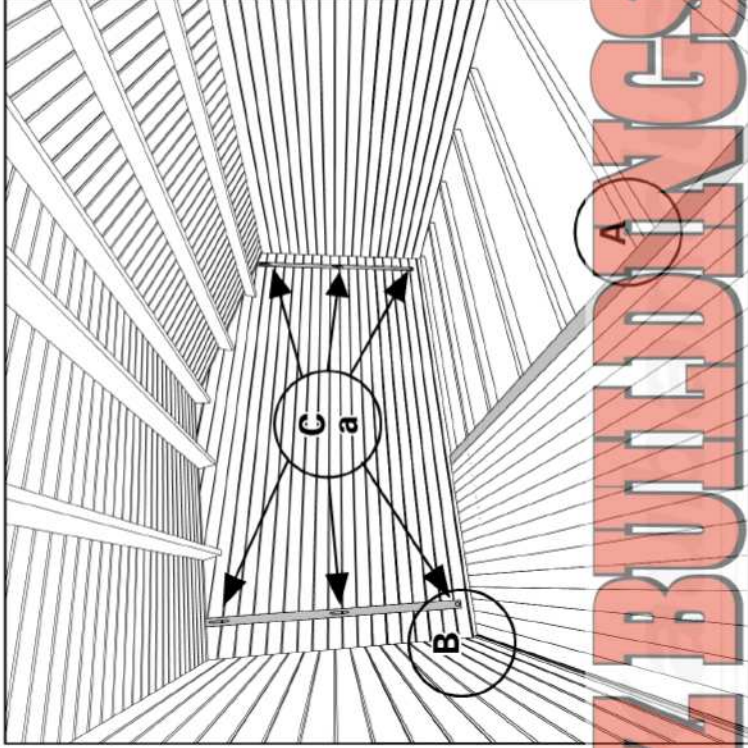
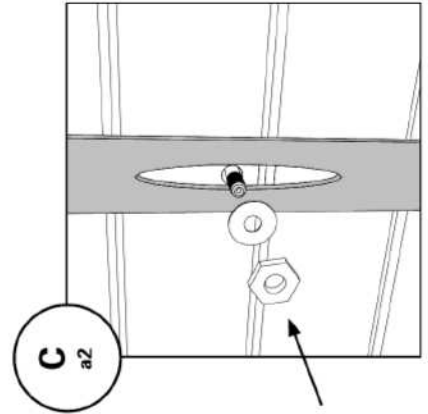
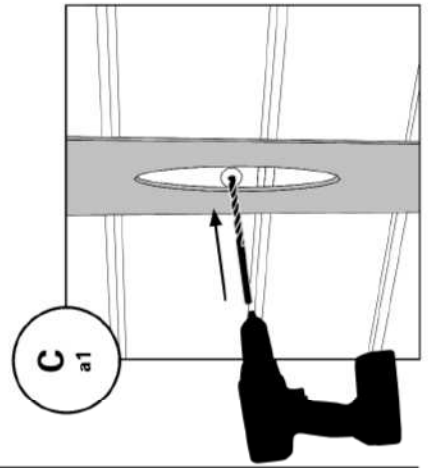
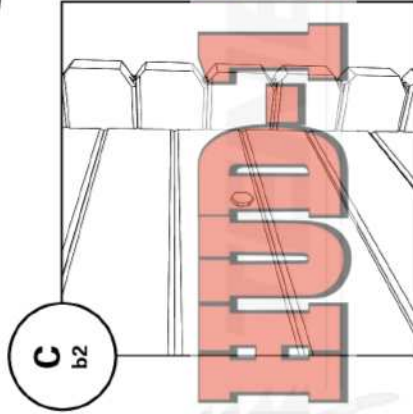
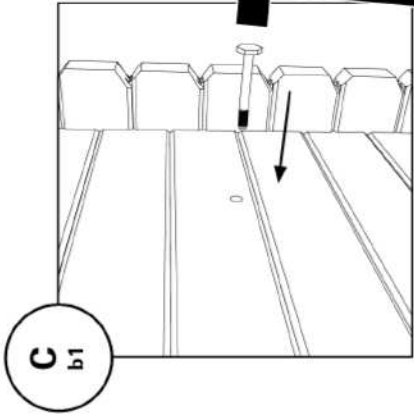
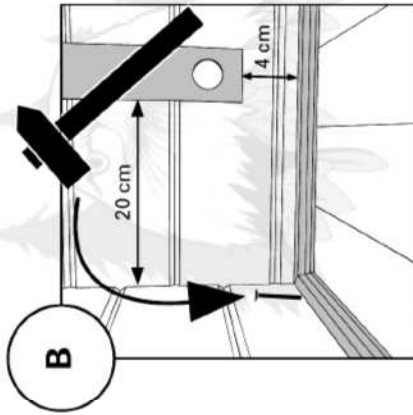
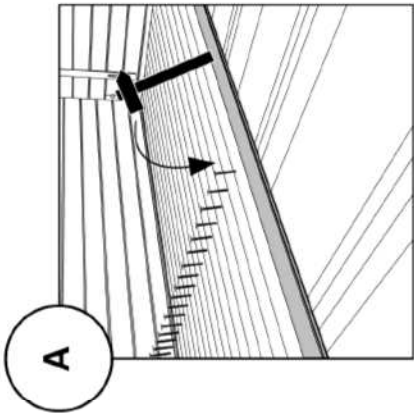

# HOW TO BUILD

