

**ITEM NO.: A101012500**

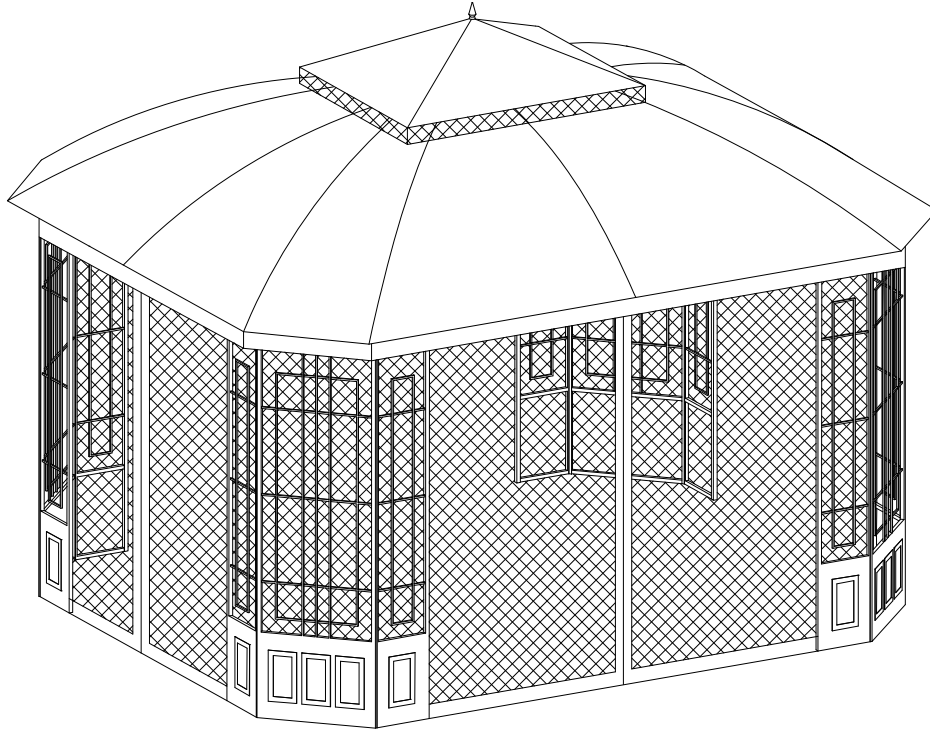

**WE HAVE YOU IN MIND, LET US SERVE YOU!**

Questions? Issues?

**CONTACT US**

24 hours / 7 days a week

 **Warranty Parts**

[www.sunjoyonline.com](http://www.sunjoyonline.com)













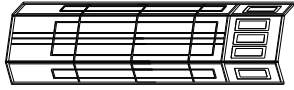

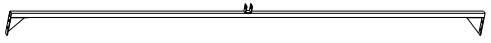

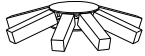
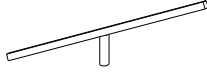

[customer.care@sunjoygroup.com](mailto:customer.care@sunjoygroup.com)

**Toll Free**

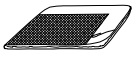

**1-(866)-578-6569**

## Parts List

Screen	A	P006300081	4	
Long Beam	D	P000400936	2	
Short Beam	E	P000400937	2	
Pipe under slant beam	F	P000601475	8	
Slant Beam For Big Roof (long)	G	P000601472	4	
Slant Beam For Big Roof (short)	H	P000601471	4	
Middle Beam (long)	I	P000601474	2	
Middle Beam (short)	J	P000601473	2	
Pipe upper slant beam	K	P000601470	4	
Big top connector	L	P000501255	1	
Slant Beam For Small Roof	M	P000601469	4	
Small top connector	N	P000501254	1	
Hook	O	P005800001	1	
Finial	P	P001000037	1	
Small canopy	Q	P001100577	1	
Big canopy	R	P001100578	1	
Mosquito Netting	S	P001200226	1	
Regulating tube	T	P005700732	16	

**Hardware Pack 1**

AA	H010020011	M6X15 bolt	16PCS	
BB	H050010020	M6 flat washer	16PCS	
W	H090010017	M6 wrench	1 PC	

**Step 1**

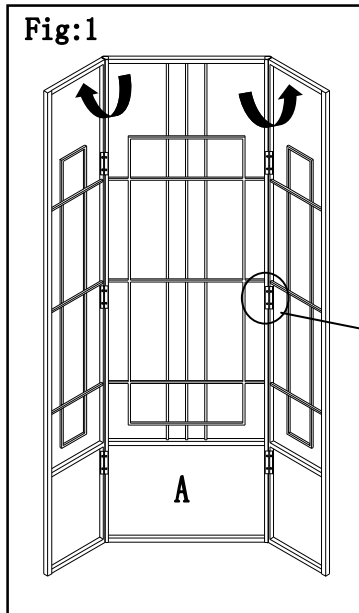
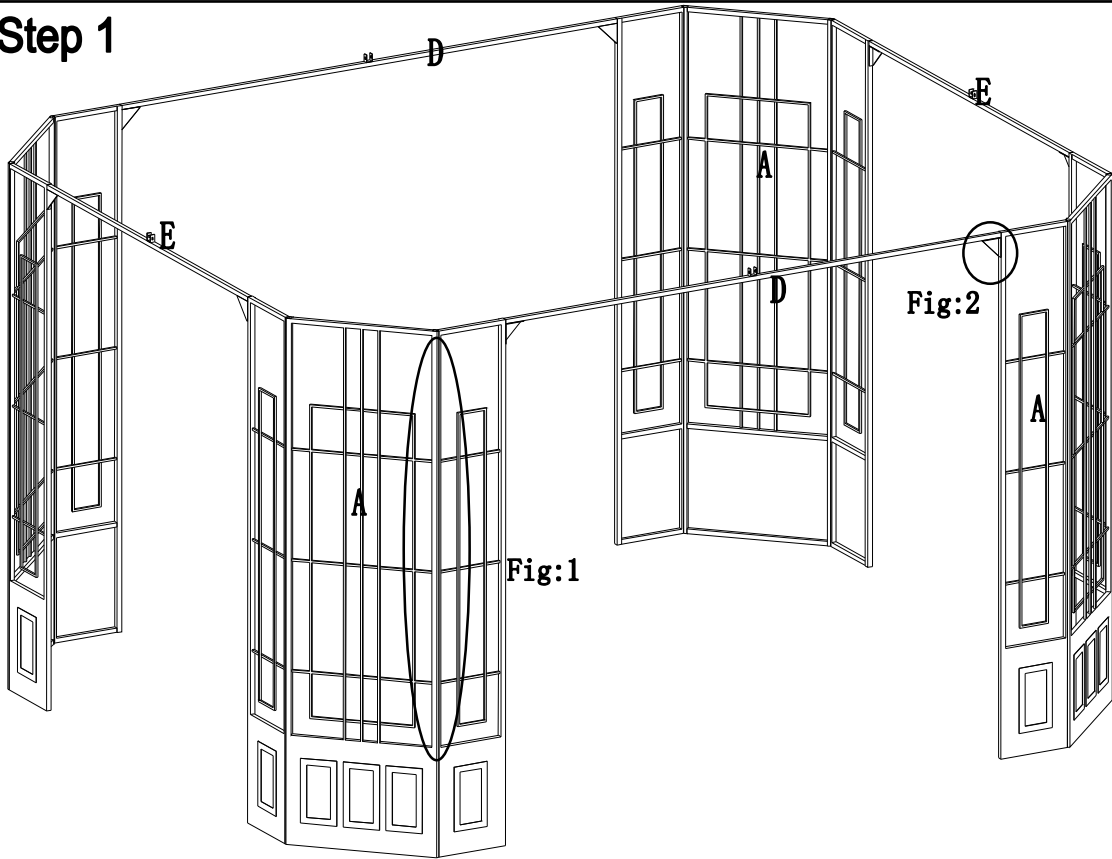

Fig:1: Open the Screen (A)

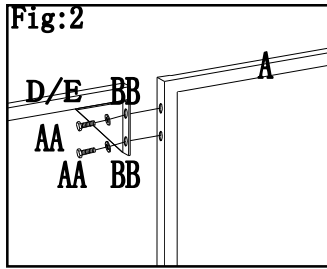

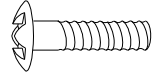



Fig.2: Attach Long Beam (D) to Screen (A) by using bolt (AA) ,washer (BB) .the same to the short beam (E)。

**Hardware Pack 2**

BB	H050010020	M6 flat washer	8PCS	
CC	H010110029	M6*35 bolt	4PCS	
DD	H040010004	M6 nut	4 PC	

**Step 2**

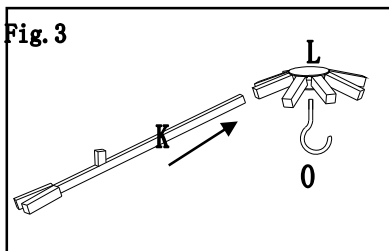
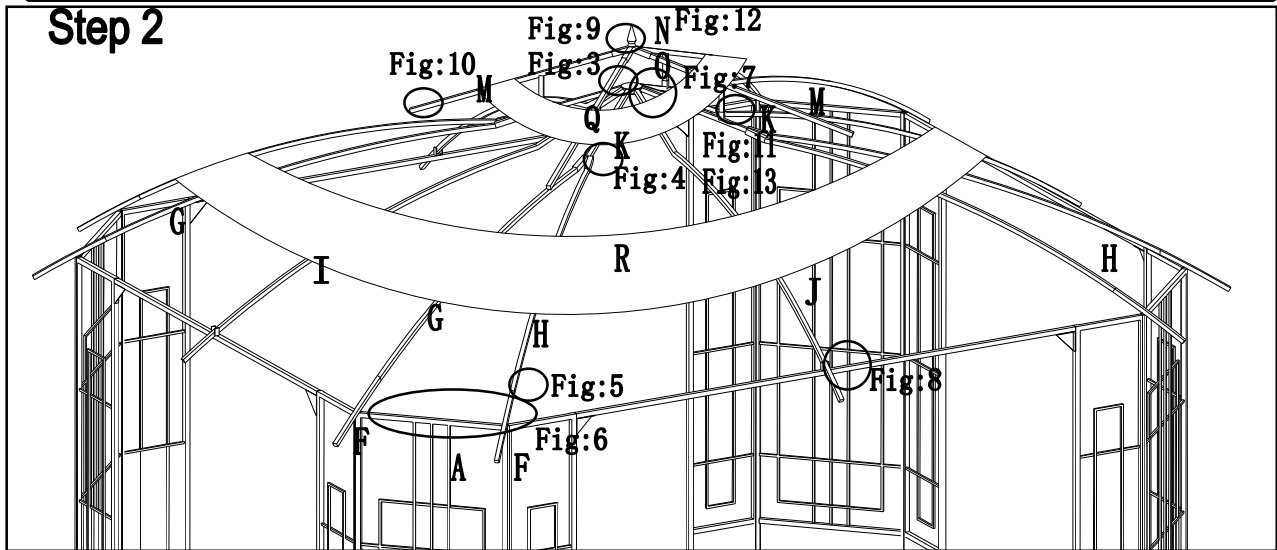

Fig.3:Screw the hook(O) to big top connector(L),then Insert Pipe upper slant beam(K) to big top connector(L).

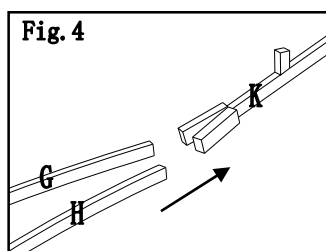

Fig.4: Insert Slant Beam For Big Roof (long/short) (G/H) to Pipe upper slant beam(K).

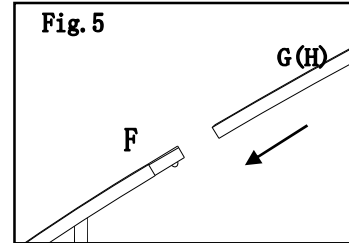

Fig.5: Insert Slant Beam For Big Roof (long/short) (G/H) to Pipe under slant beam(F).

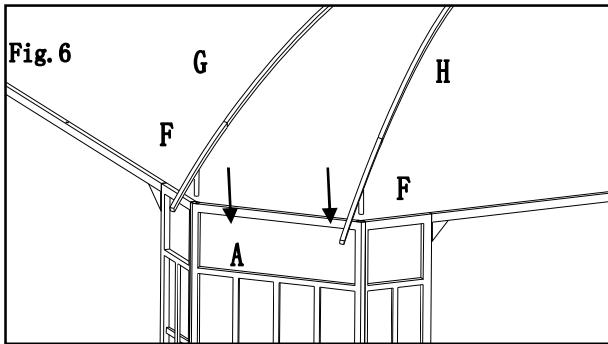

Fig.6: Insert Pipe under slant beam(F) to screen(A).

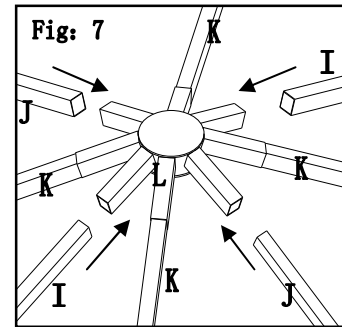

Fig.7: Insert Middle Beam (long/short) (I/J) to big top connector(L).

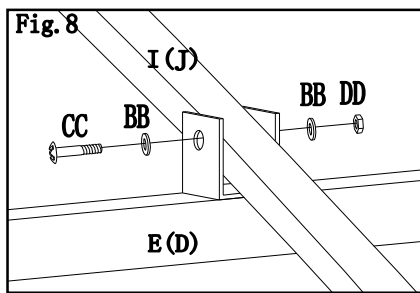

Fig.8: Attach Middle Beam (long/short) (I/J) to Long Beam (D) and short Beam (E) by using bolt (CC),washer (BB) and nut

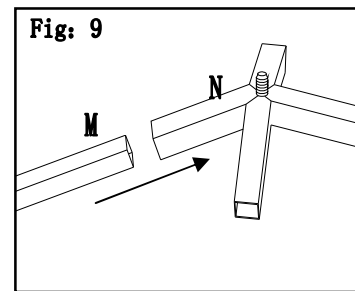

Fig.9: Insert Slant Beam For Small Roof(M) to Small top connector (N) .

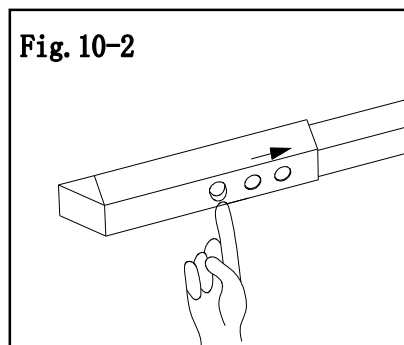
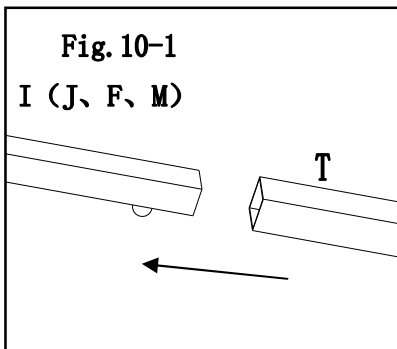

Fig.10-1、 Fig.10-2:Install the adjusting pipe(T) to the lower endof the big top middle beam (I&J) and the small top inclined beam (M)of the Pipe under slant beam (M),and close it to the minimum.

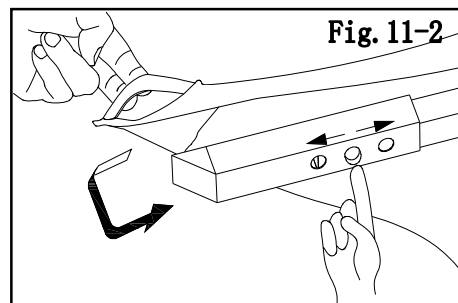
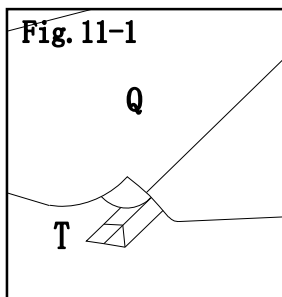

Fig.11-1、 Fig.11-2:Place the small top cloth(Q) on the four corners of thetop,then adjust the position of the adjusting pipe until the small top cloth is tight.

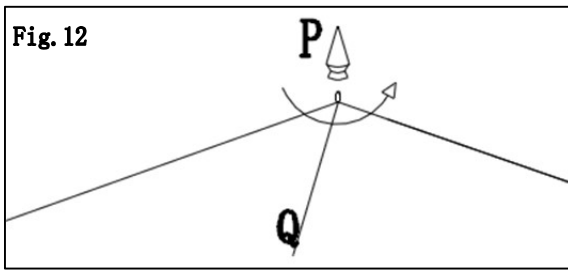

Fig.12:Install the top flower (P)on the top of the small top.

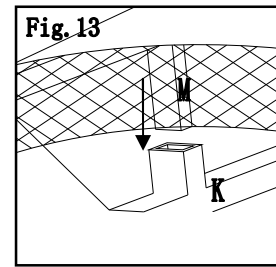

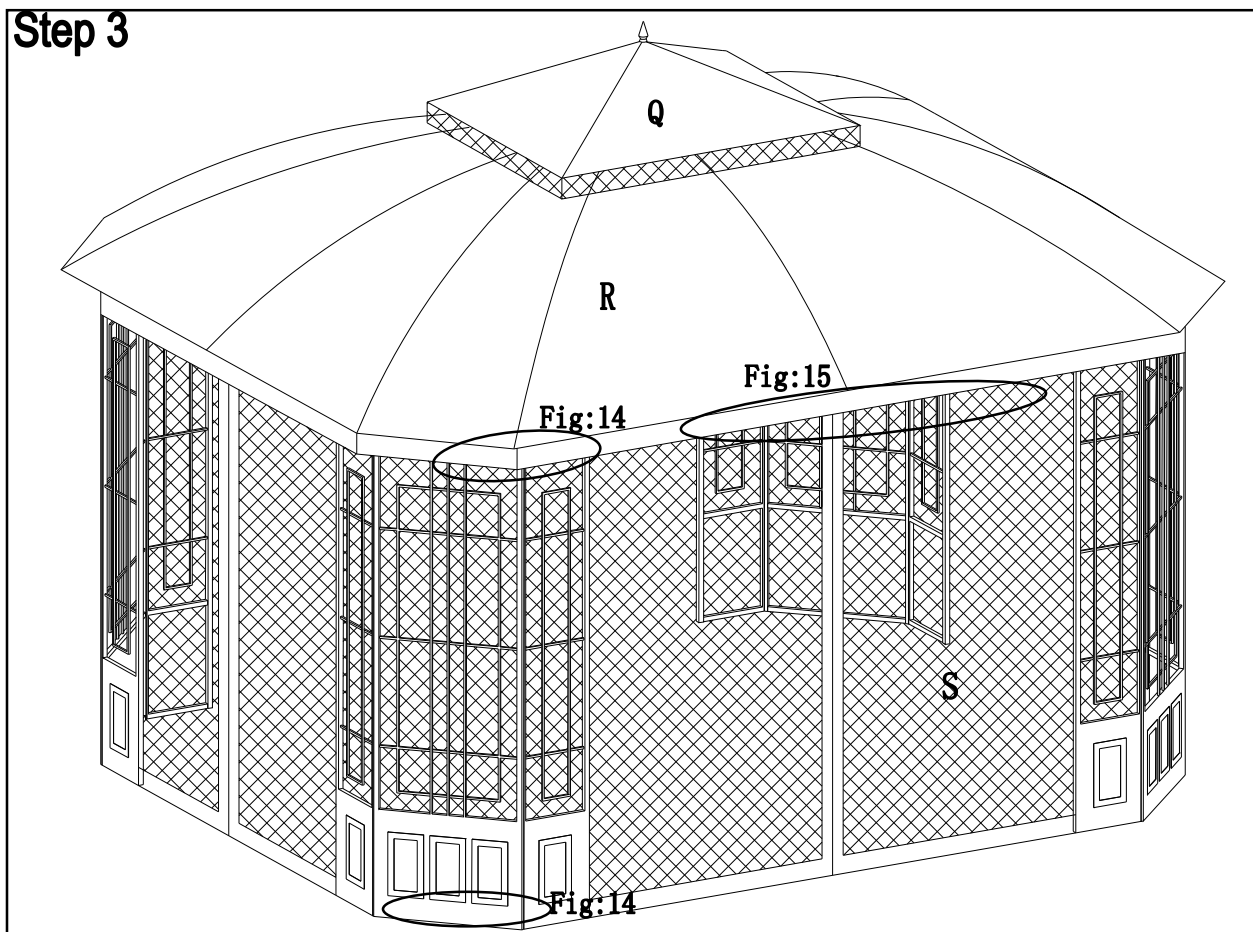

Fig.13:Put big canopy (R) to big top,don't open, then Insert small top to Pipe upper slant beam(K).

### Hardware Pack 3

EE	P005100265	Ring	52PCS	
FF	H070010010	"7" stake $\varnothing$ 6*230	12PCS	

### Step 3



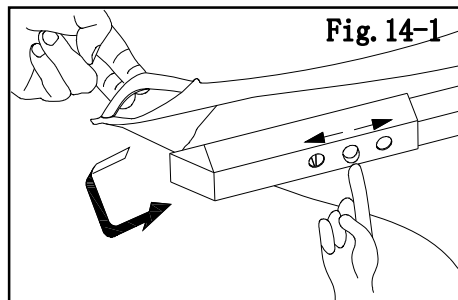
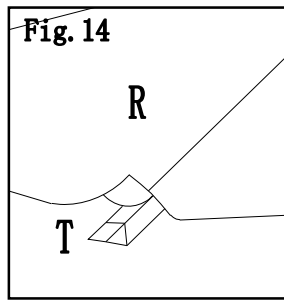

Fig.12:After adjusting the top top cloth the top,adjust the adjusting pipe until the top cloth is tight.

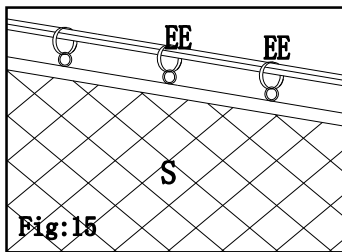

Fig.15:Hang.Mosquito Netting(S) to Beam by using ring(EE).

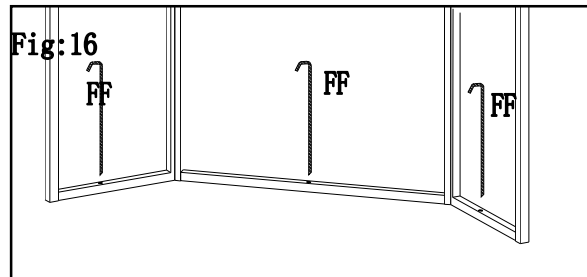

Fig.16: By using stake(FF) fix assembled gazebo on ground.

## Care and Maintenance

- Our steel components for garden accessories and furniture are treated with rust inhibiting paint that protects it from rusting. However, due to the nature of steel, surface oxidation (rusting) will occur once these protective coatings are scratched. This is not a defect and thus not covered by the warranty.
- To minimize this condition, we recommend care when assembling & handling the product to prevent scratching the paint. Should any scratching or damage occur, we recommend immediate touch-up with rust inhibiting paint.
- Surface rust can also be easily removed with a very light application of common cooking oil. If surface oxidation (rusting) occurs and if no measure is taken to prevent this, the oxidation may start dripping on to deck or patio and caused damaging stains, which may be difficult to remove. This can be prevented if the above-mentioned measures are taken to keep the product from oxidizing.
- Use damp cloth to wipe off the stains as quickly as possible.
- If necessary, wash with a mild solution of soap and water; rinse thoroughly and dry completely.
- Periodically check and ensure that all bolts are well-tighten during use

## Limited Manufacturer's Warranty

Sunjoy Group warrants to the original purchaser that this item is free from defects in workmanship and materials for a period of **1 year** from the date of purchase, provided the item was factory-sealed at the time of purchase and is maintained with care and used only for personal, residential purposes. Should any manufacturing defect arise within this warranty period, Sunjoy Group will replace (at our option) any defective merchandise or parts upon proof of purchase; however, transportation and delivery costs, as well as payments to a third party for assembly or disassembly of the item, remain the responsibility of the purchaser. A purchaser of an "open box," previously-returned, or "clearance" item, as well as original purchasers outside of the warranty period, may obtain replacement parts from Sunjoy Group for products in current production, at nominal cost.

## Exclusions:

Items used for commercial, contract, or other non-residential purposes, or items damaged due to acts of nature, vandalism, misuse, or improper assembly are not covered. Corrosion or rusting of hardware is not covered. Proof of purchase (dated register receipt) is required for warranty claims. Warranty is to the original purchaser and is non-transferable. Any replacement of warranted items will be in the original style and color, or a similar style and color if the original is unavailable or has been discontinued. As some states do not allow exclusions or limitations on an implied warranty, the above exclusions and limitations may not apply. This warranty gives you specific rights, and you may also have other rights, which vary from state to state.