

**ITEM NO.:A101011400**

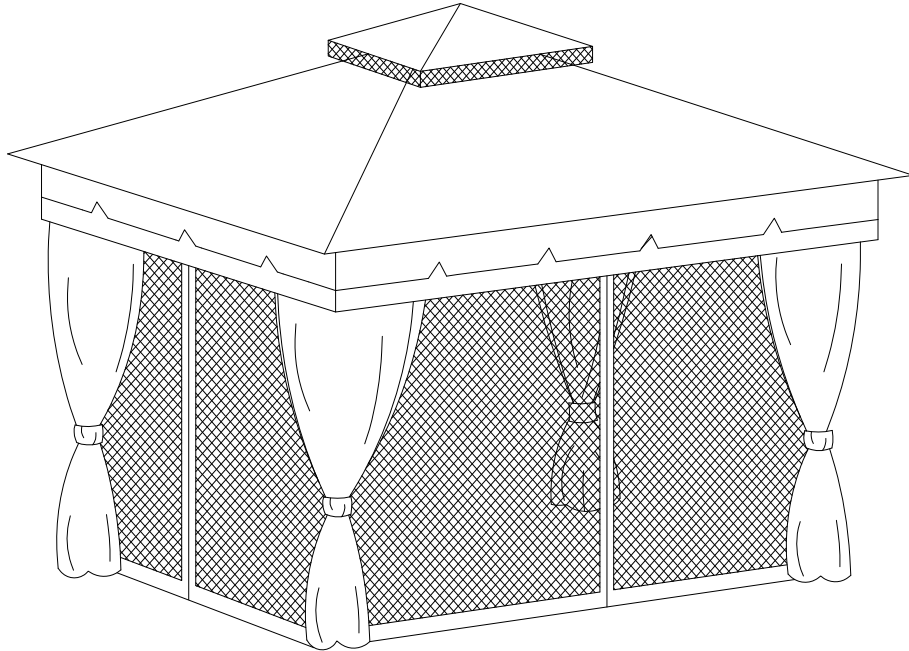

**WE HAVE YOU IN MIND, LET US SERVE YOU!**

Questions? Issues?

**CONTACT US**

24 hours / 7 days a week

 Warranty Parts

[www.sunjoyonline.com](http://www.sunjoyonline.com)













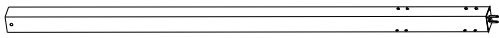
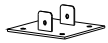

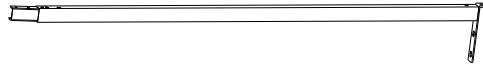
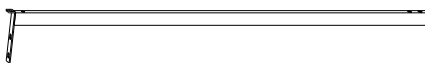

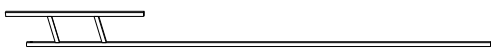

[customer.care@sunjoygroup.com](mailto:customer.care@sunjoygroup.com)

Toll Free

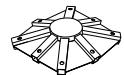
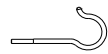

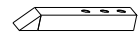

1-(866)-578-6569

## Parts List

Post	A1	P000200397	4	
Base	B	P000100297	4	
Base cover	C	P006100153	4	
Long beam(short side)	D1	P000400804	2	
Short beam(short side)	E1	P000400805	2	
Long beam(long side)	F1	P000400806	2	
Short beam(long side)	G1	P000400807	2	
Bottom tube of slanting beam	H1	P000601213	4	
Middle beam connector	I1	P000501036	4	
Slanting bar	J1	P000601212	4	
Long middle beam	L1	P000601214	2	
Short middle beam	M1	P000601215	2	
Long netting bar	N1	P005700596	4	
Short netting bar	O1	P005700597	4	
Big top connector	P1	P000501035	1	
Hook	Q1	P005800001	1	
Big canopy	T1	P001100487	1	
Small canopy	U1	P001100488	1	
Curtain	V	P001300097	1	
Mosquito Netting	W	P001200193	1	
Slanting support bar	X1	P005000350	8	
Adjustable tube	Y	P005700595	12	

**Hardware Pack 1**

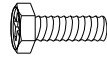
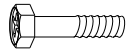
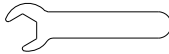
AA	M6x15 bolt	H010110016	8PCS	
BB	M6 flat washer	H050010023	88 PCS	
CC	M6x15 bolt	H010020011	48PCS	
HH	M6x35 bolt	H010020013	32 PCS	
Z	M6 Wrench	H090010009	2 PC	

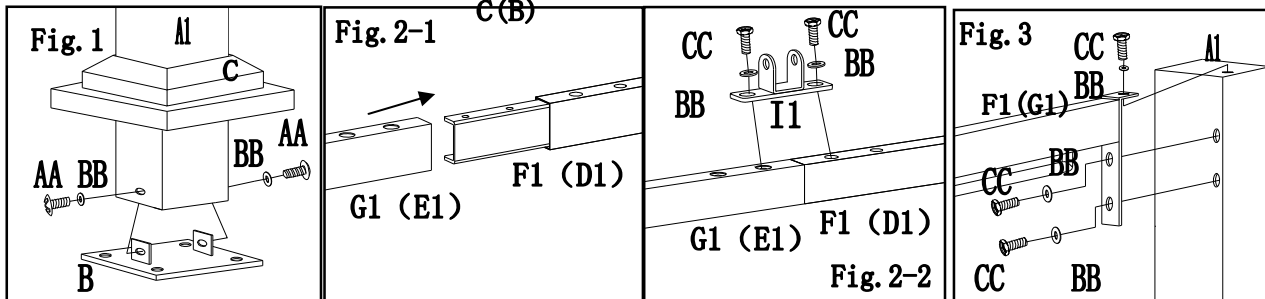
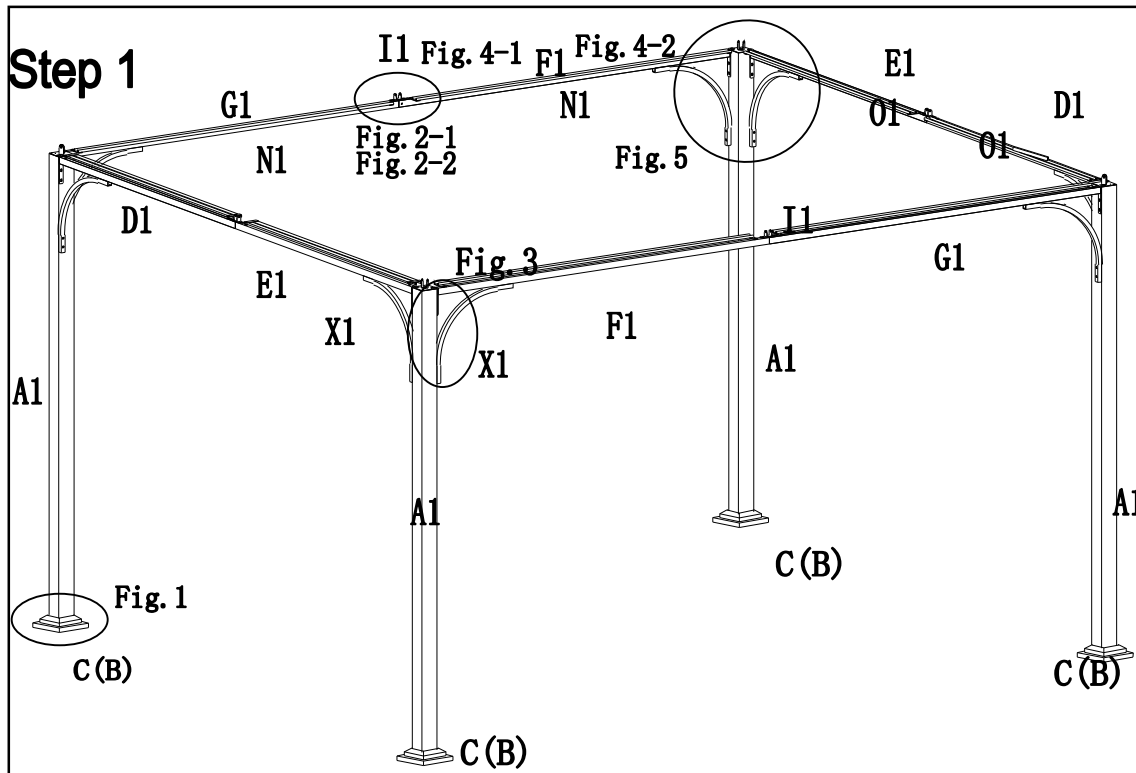
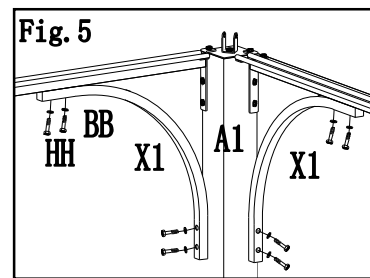
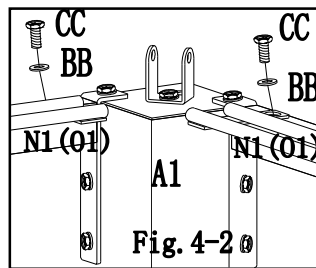
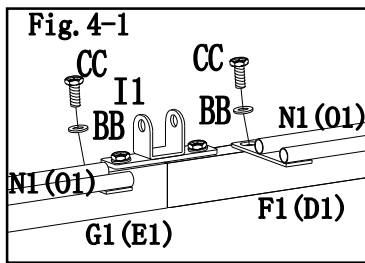

**Fig.1:** Put base cover (C) through bottom of post(A1), then attach base(B) to Post(A1) by using bolt(AA) and flat washer(BB).

**Fi2-1:**Insert shortbeam(long side)(G1) to long beam(long side) (F1), Repeat the step for short side beam(E1)/(F1).

**Fig.2-2:** Attach middle beam connector(I1) to beam (long side) (F1 /G1),by using bolt (CC) flat washer (BB) , repeat step for short side beam(E1/D1)。

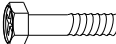

**Fig.3:** Attach the assembled beam to post(A1), then fix bearing bolt (CC) and flat washer(BB)



**Fig.4-1、 Fig.4-2:** Attach netting bar (N1、 O1) to across beam(F1、 D1、 G1、 E1),then fix by using bolt (CC) Flat washer (BB) .

**Fig.5:** Attach the slanting support bar (X1) to across beam and post (A1) fix by using bolt (HH) and flat washer (BB) .

### Hardware Pack 2

BB	M6 flat washer	H050010023	16 PCS	
HH	M6x35 bolt	H040010011	8 PCS	
EE	M6 nut	H040010011	8 PCS	

### Step 2

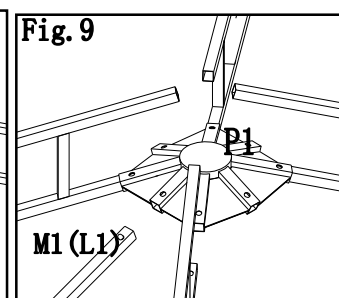
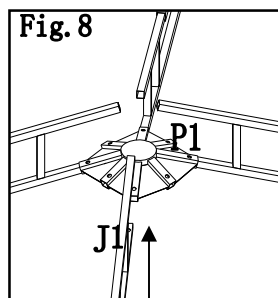
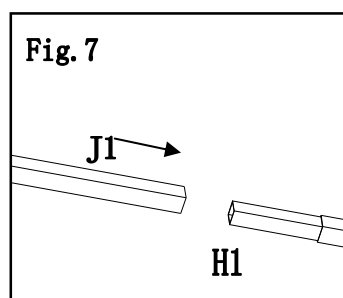
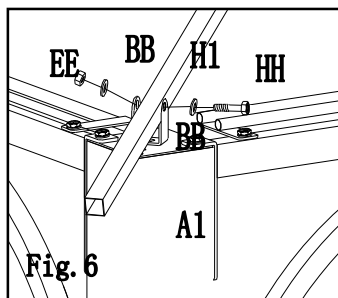
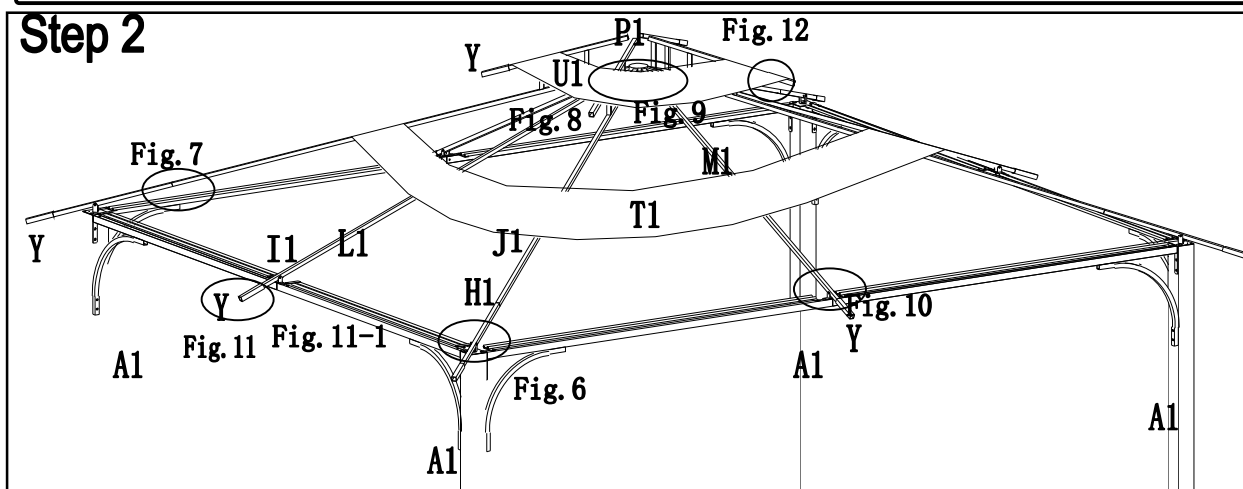
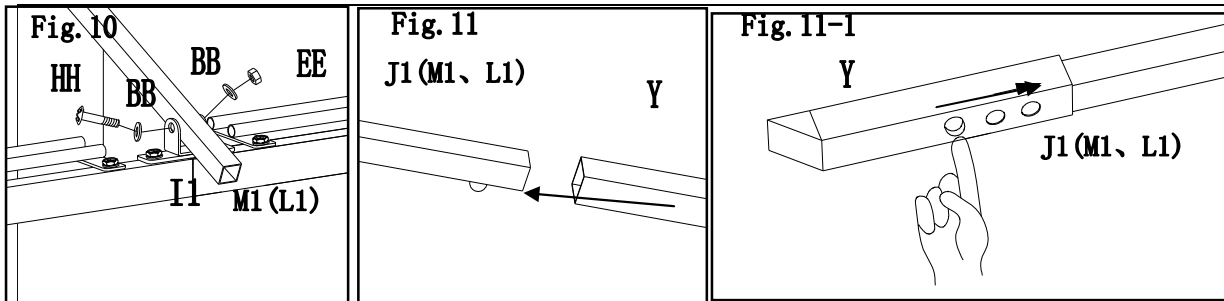

**Fig.6:** Attach slanting beam bottom tube(H1) to top of post (A1),fix by using bolt (HH)、 flat washer (BB) and nut (EE) .

**Fig.7:**Insert slanting bar (J1) to slanting bar bottom tube (H1)。

**Fig.8:** Insert slanting bar (J1) to big top connector (P1) .

**Fig.9:** Insert short middle beam(M1) and long middle beam(L1) to big top connector(P1).

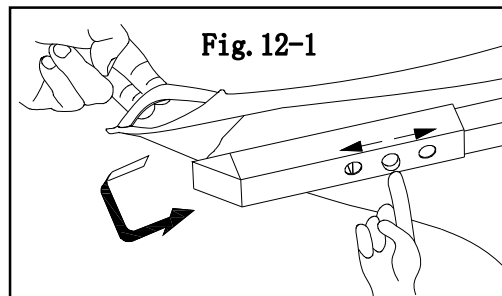
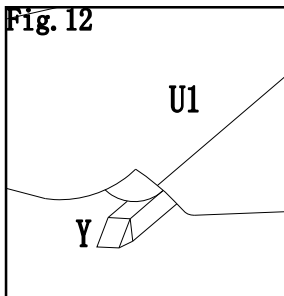

**Fig.10:** Fix long middle beam(L1) and short middle beam(M1) to middle beam connector(I1), by using bolt (HH)、flat washer (BB) and nut (EE) .

**Fig.11:** Attach adjustable tube (Y) to slanting beam (J1) long beam、short beam、middle beam (L1、M1)。

**Fig.11-1:** insert the adjustable tube ( Y )

to slanting beam ( J1、 M1、 L1 ) ( to the inner mounting hole)



**Fig.12:** Fix small canopy (U1) to slanting beam (J1) (adjust tube (Y) according to the canopy size as Fig.12-1)。

**Hardware Pack 3**

FF	Φ6x230MM 7stake	H070010008	8 PCS	
GG	Ring	R079990136	104 PCS	

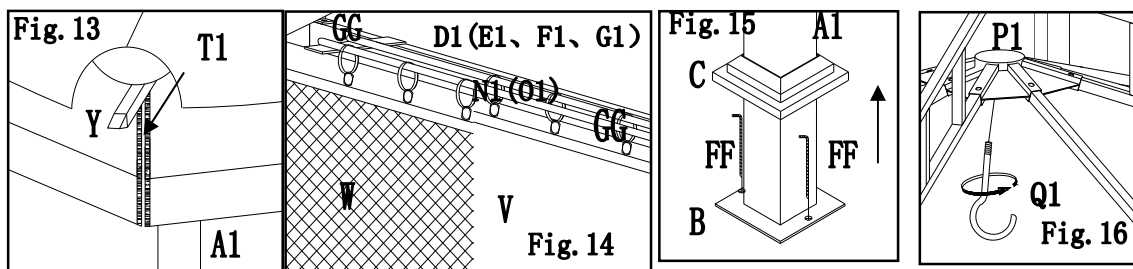
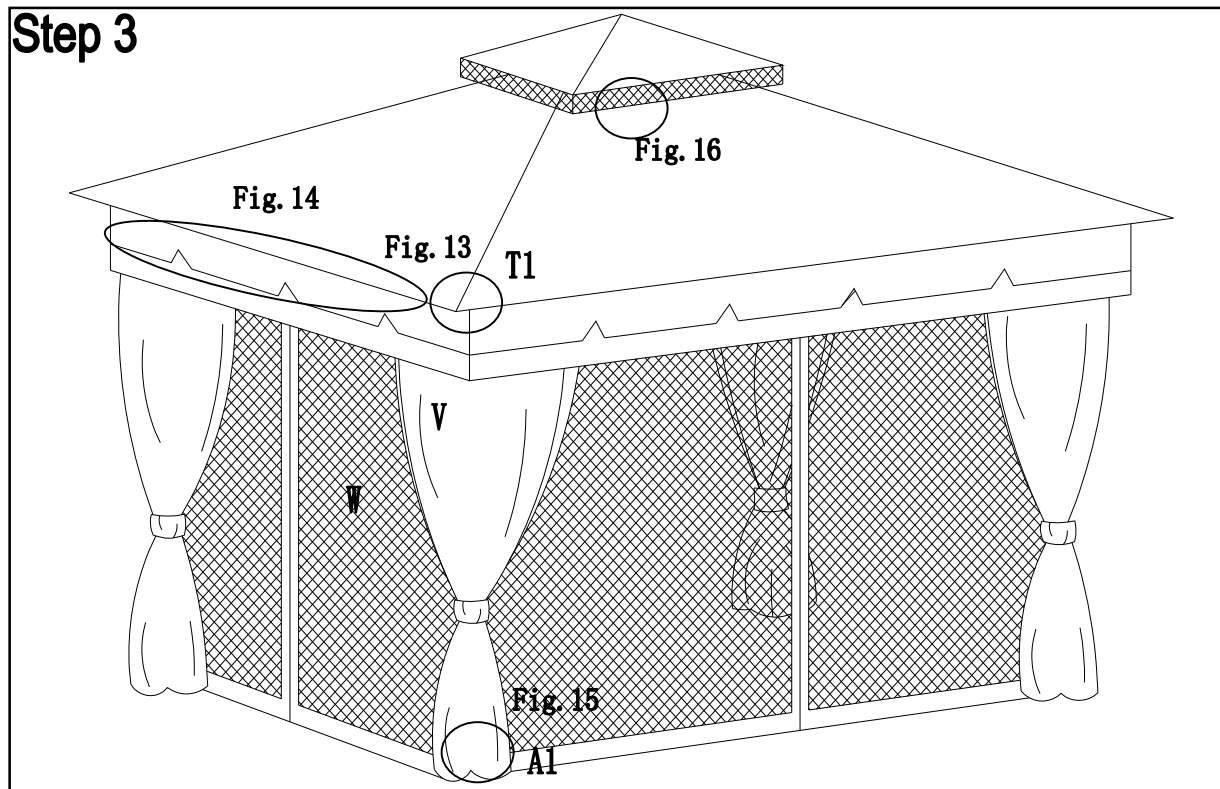

**Fig.13:** Spread big canopy (T1), fix the four corner to slanting beam adjustable tube (Y), then close side edge Velcro.

**Fig.14:** Hang mosquito netting (W) and Curtain (V) to across beam and netting bar, by using ring (GG).

**Fig.15:** Up the base cover (C), fix assembled gazebo on the ground by using Stake (FF).

**Fig.16:** Attach hook (Q1) to big top connector (P1).

## Care and Maintenance

- Our steel components for garden accessories and furniture are treated with rust inhibiting paint that protects it from rusting. However, due to the nature of steel, surface oxidation (rusting) will occur once these protective coatings are scratched. This is not a defect and thus not covered by the warranty.
- To minimize this condition, we recommend care when assembling & handling the product to prevent scratching the paint. Should any scratching or damage occur, we recommend immediate touch-up with rust inhibiting paint.
- Surface rust can also be easily removed with a very light application of common cooking oil. If surface oxidation (rusting) occurs and if no measure is taken to prevent this, the oxidation may start dripping on to deck or patio and caused damaging stains, which may be difficult to remove. This can be prevented if the above-mentioned measures are taken to keep the product from oxidizing.
- Use damp cloth to wipe off the stains as quickly as possible.
- If necessary, wash with a mild solution of soap and water; rinse thoroughly and dry completely.
- Periodically check and ensure that all bolts are well-tighten during use

## Limited Manufacturer's Warranty

Sunjoy Group warrants to the original purchaser that this item is free from defects in workmanship and materials for a period of **1 year** from the date of purchase, provided the item was factory-sealed at the time of purchase and is maintained with care and used only for personal, residential purposes. Should any manufacturing defect arise within this warranty period, Sunjoy Group will replace (at our option) any defective merchandise or parts upon proof of purchase; however, transportation and delivery costs, as well as payments to a third party for assembly or disassembly of the item, remain the responsibility of the purchaser. A purchaser of an "open box," previously-returned, or "clearance" item, as well as original purchasers outside of the warranty period, may obtain replacement parts from Sunjoy Group for products in current production, at nominal cost.

## Exclusions:

Items used for commercial, contract, or other non-residential purposes, or items damaged due to acts of nature, vandalism, misuse, or improper assembly are not covered. Corrosion or rusting of hardware is not covered. Proof of purchase (dated register receipt) is required for warranty claims. Warranty is to the original purchaser and is non-transferable. Any replacement of warranted items will be in the original style and color, or a similar style and color if the original is unavailable or has been discontinued. As some states do not allow exclusions or limitations on an implied warranty, the above exclusions and limitations may not apply. This warranty gives you specific rights, and you may also have other rights, which vary from state to state.