



**ASSEMBLY GUIDE
GUIDE DE MONTAGE
GUÍA DE MONTAJE**

PILLAR PLANTER

JARDINIÈRE PILIER

PLANTADOR DE PILARES

VT17514 / VT17614
ESPRESSO SLATE

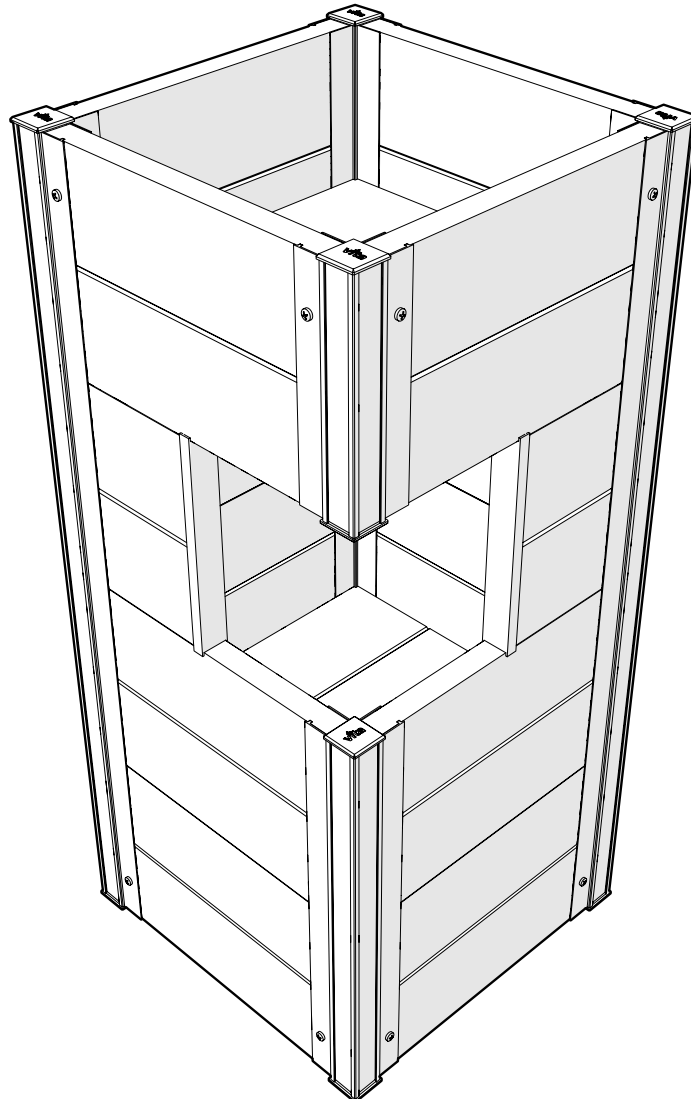

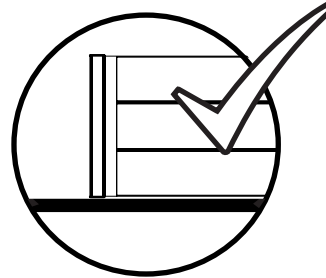
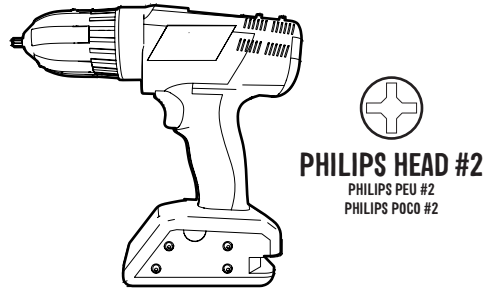
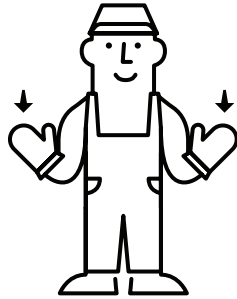
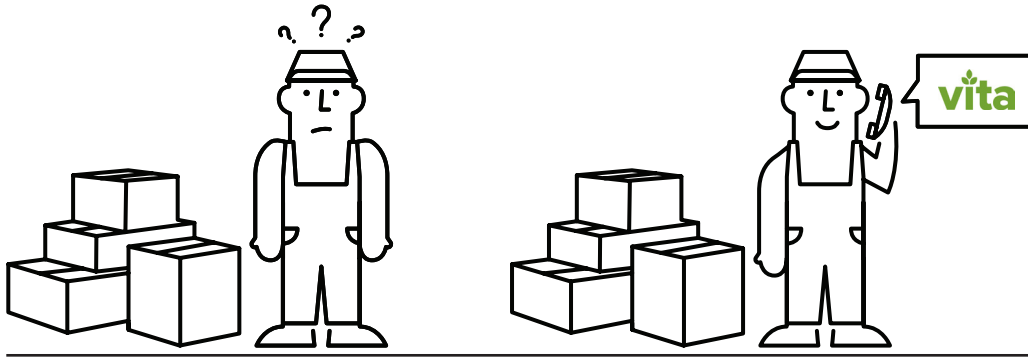

 1-844-880-8482



 [44] 2038 687160



SOS@VITAGARDENS.COM



WWW.VITAGARDENS.COM



8: 00 AM - 4: 00 PM EST



PARTS LIST

LISTA DE PARTES

LISTE DES PIÈCES

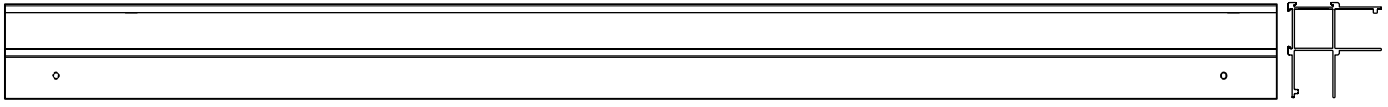

16007 - POST A - 29 1/2IN (74.7CM) - X3

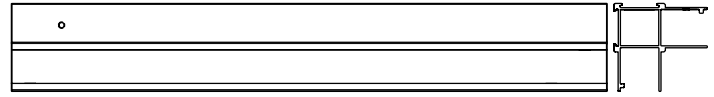

16008 - POST B - 14 3/4IN (37.3CM) - X1

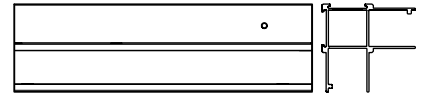

16009 - POST C - 7 3/8IN (18.6CM) - X1

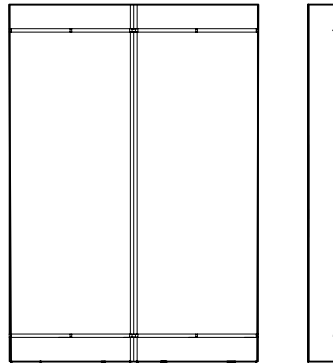

16010 (SLATE) / 17010 (ESPRESSO)
BOARD A - 10 5/8IN (27CM) - X6

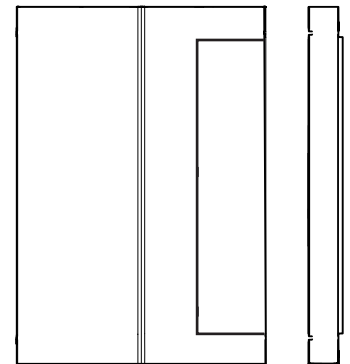

16011 (SLATE) / 17011 (ESPRESSO)
BOARD B - 10 5/8 IN (27CM) - X8

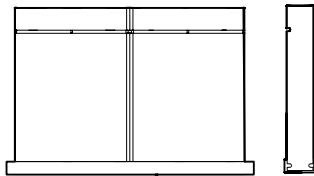

16012 (SLATE)/17012 (ESPRESSO)
BOARD C - 5IN (13.5CM) - X2

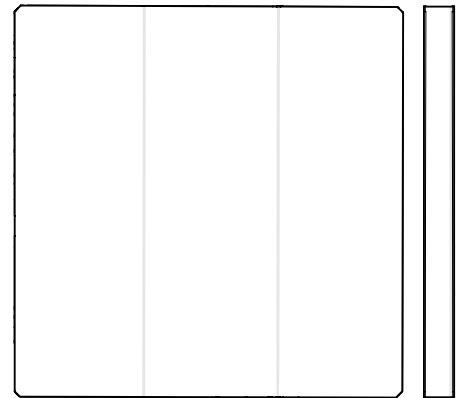

16013 (SLATE) / 17013 ESPRESSO
FLOOR BOARD - 11IN X11IN (28CM X 28CM) X2



16003 - POST CAP - 1 1/4 X 1 1/4 (3.18CM X 3.18CM) - X10

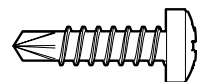

20066 - SCREW - 5/8IN X 1/8IN (1.6CM X 0.32IN) X16

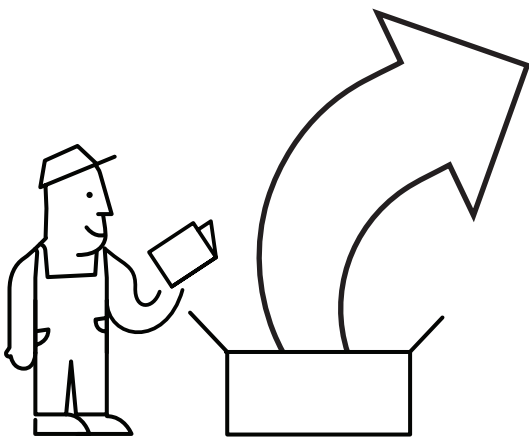

PRODUCT DIMENSIONS

DIMENSIONS DU PRODUIT

DIMENSIONES DEL PRODUCTO

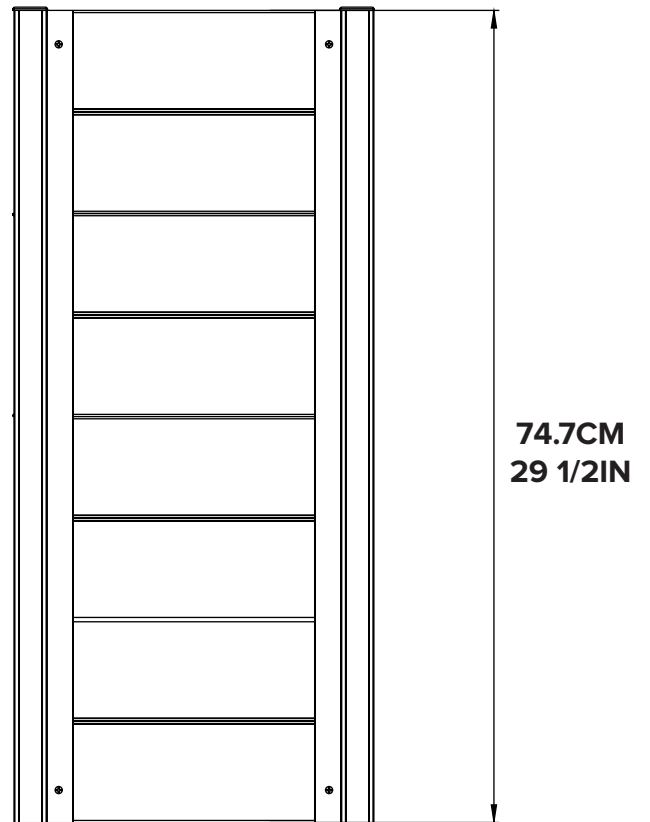
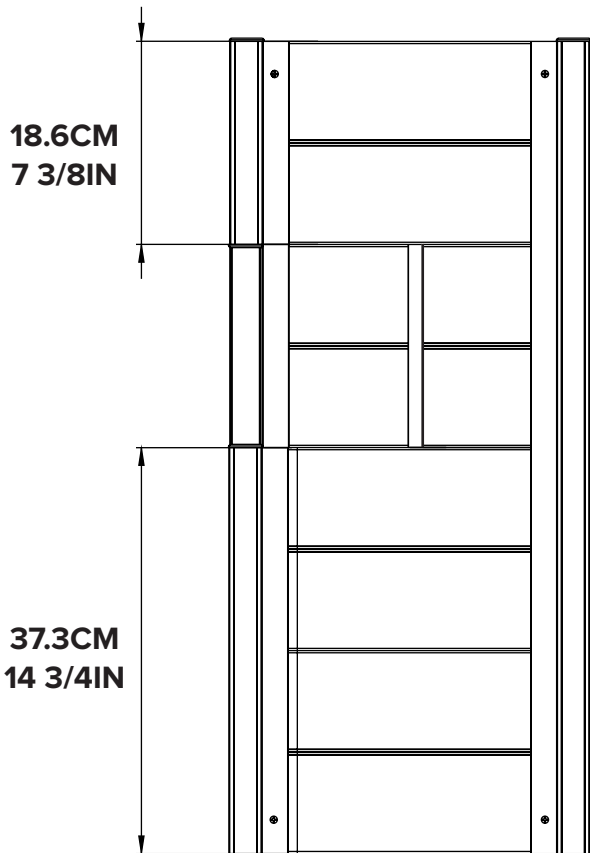
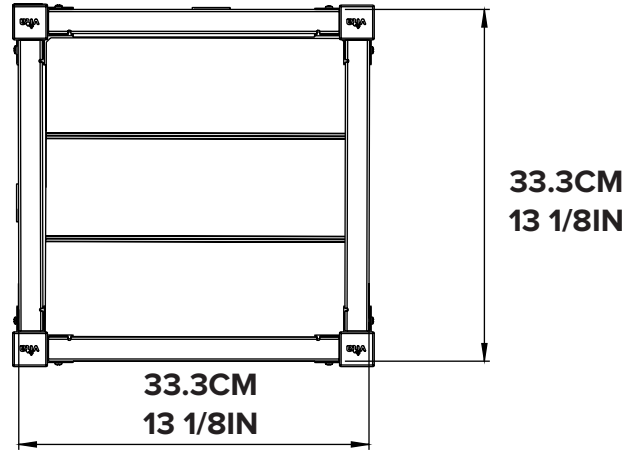

1

16007 - x2 (A)

16008 - x1 (B)

16011/17011 - x2 (B)

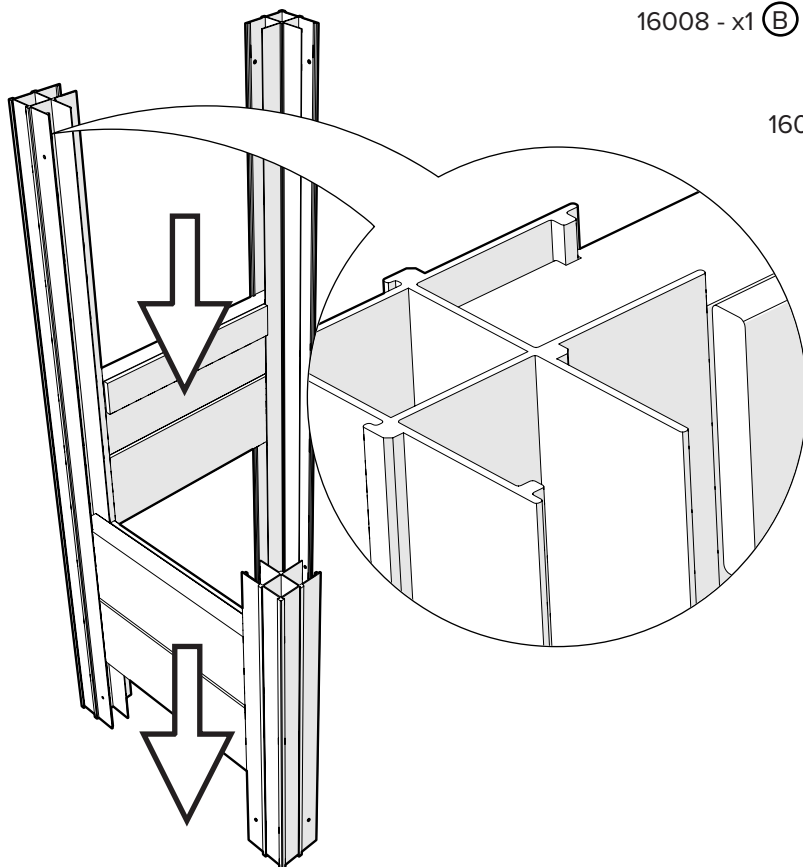

2

16007- x1 (A)

16011/17011 - x2 (B)

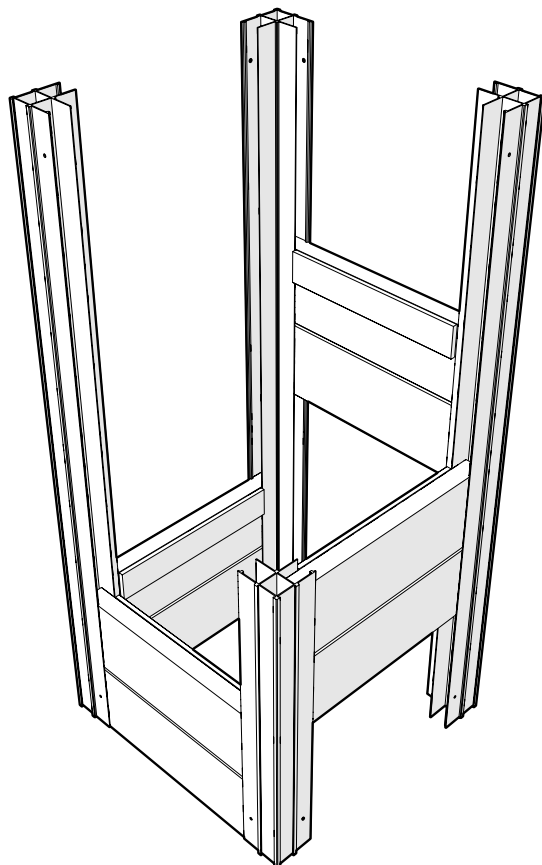

3

16010/17010 - x4 (A)

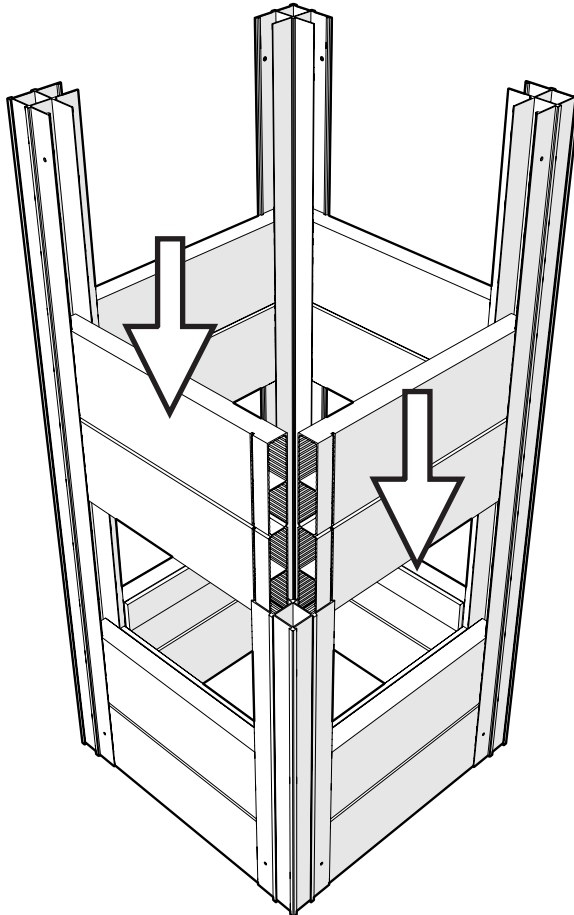

4

16013/17013 - x1

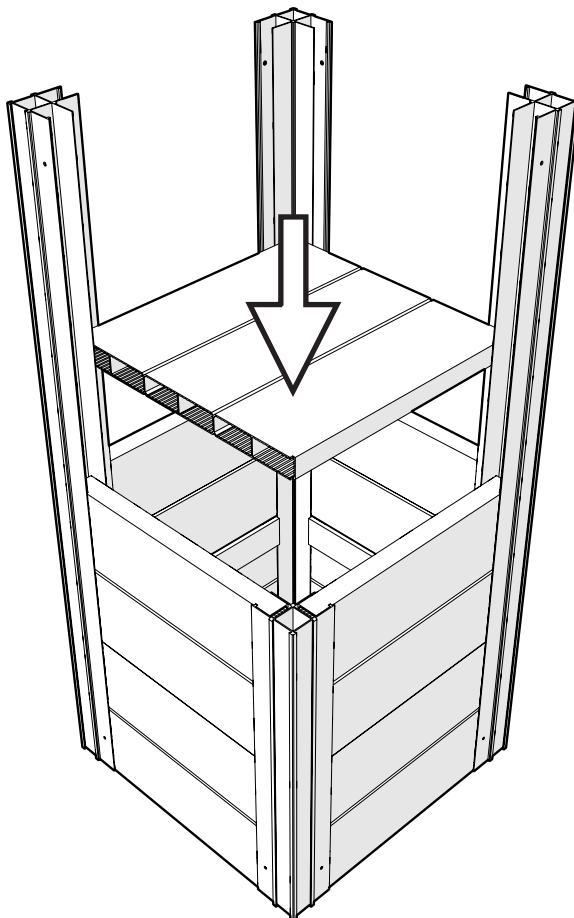

5

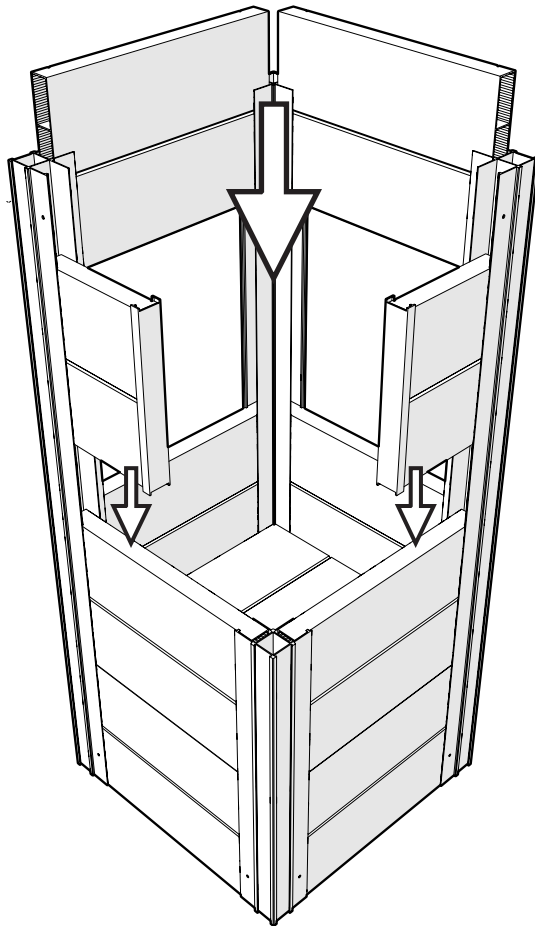

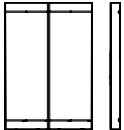
16010/17010 - x2 (A) 

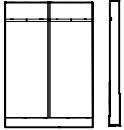
16012/17012 - x2 (C) 



6

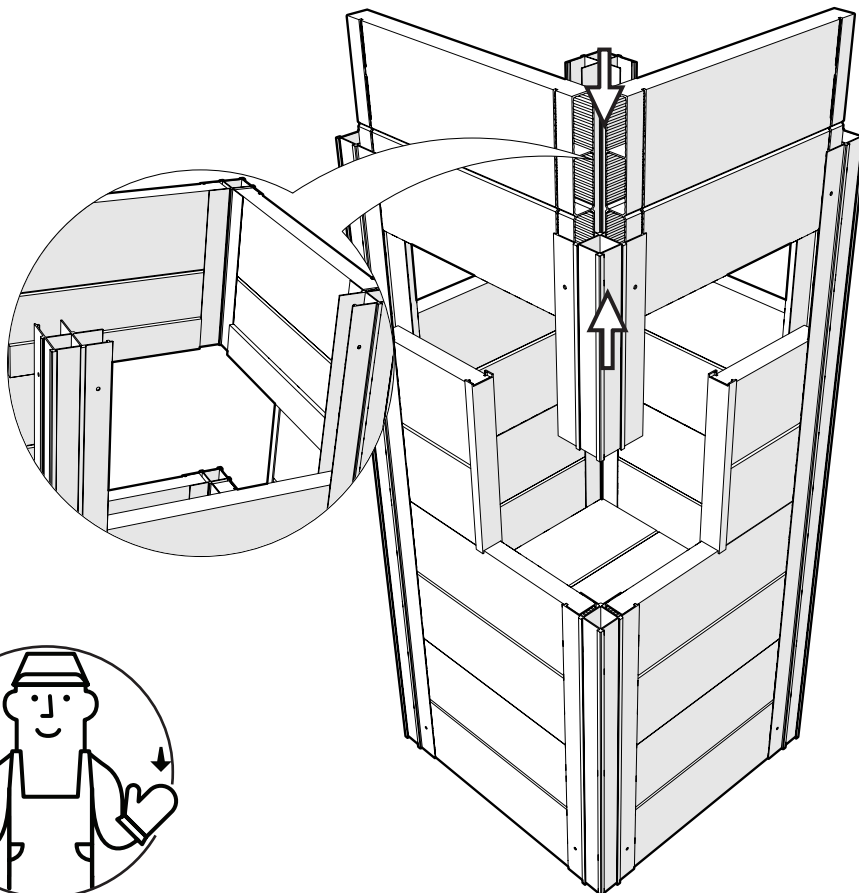

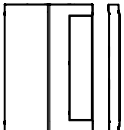
16011/17011 - x2 (B) 

16009 - x1 (C) 

16003 - x1 

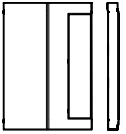

7

16011/17011 - x2 (B) 

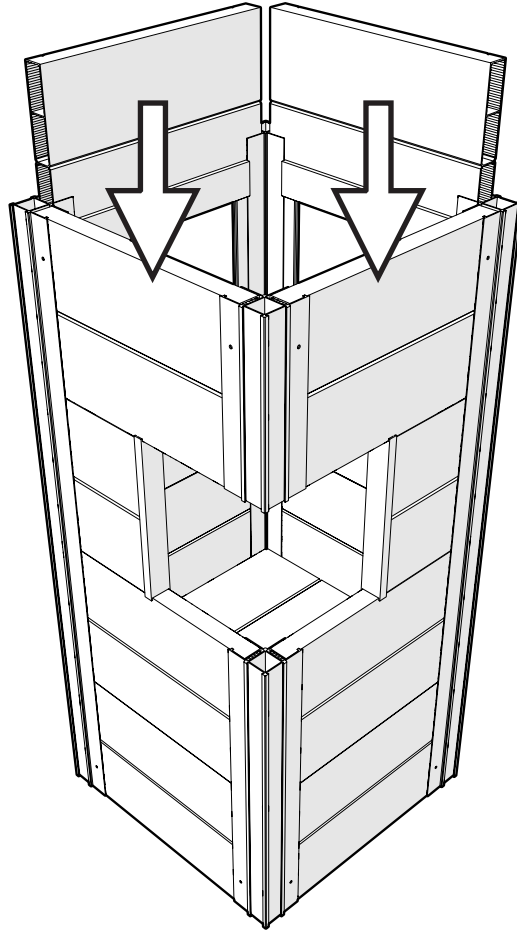

8

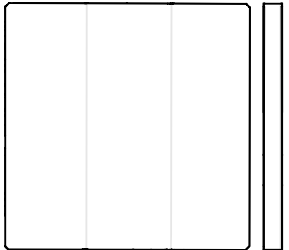
16013/17013 - x1 

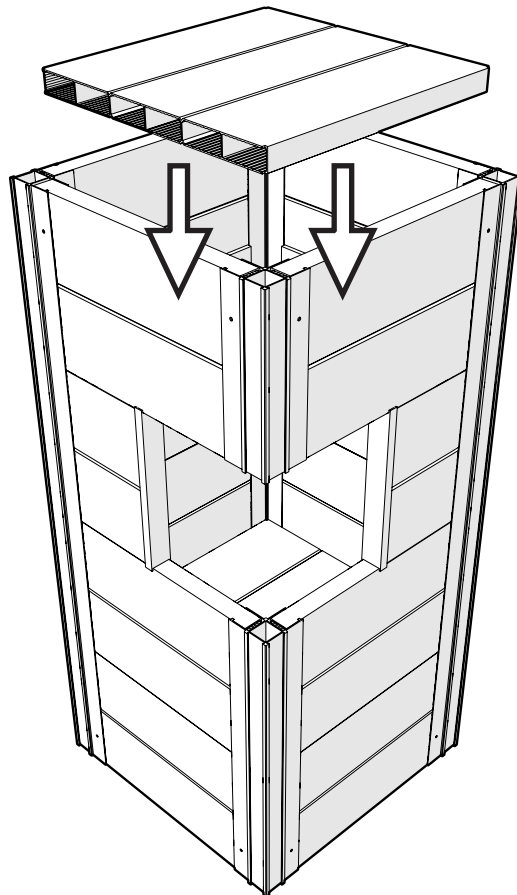

9

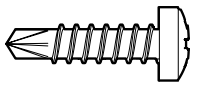
20066 - x16 

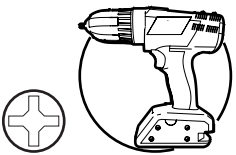
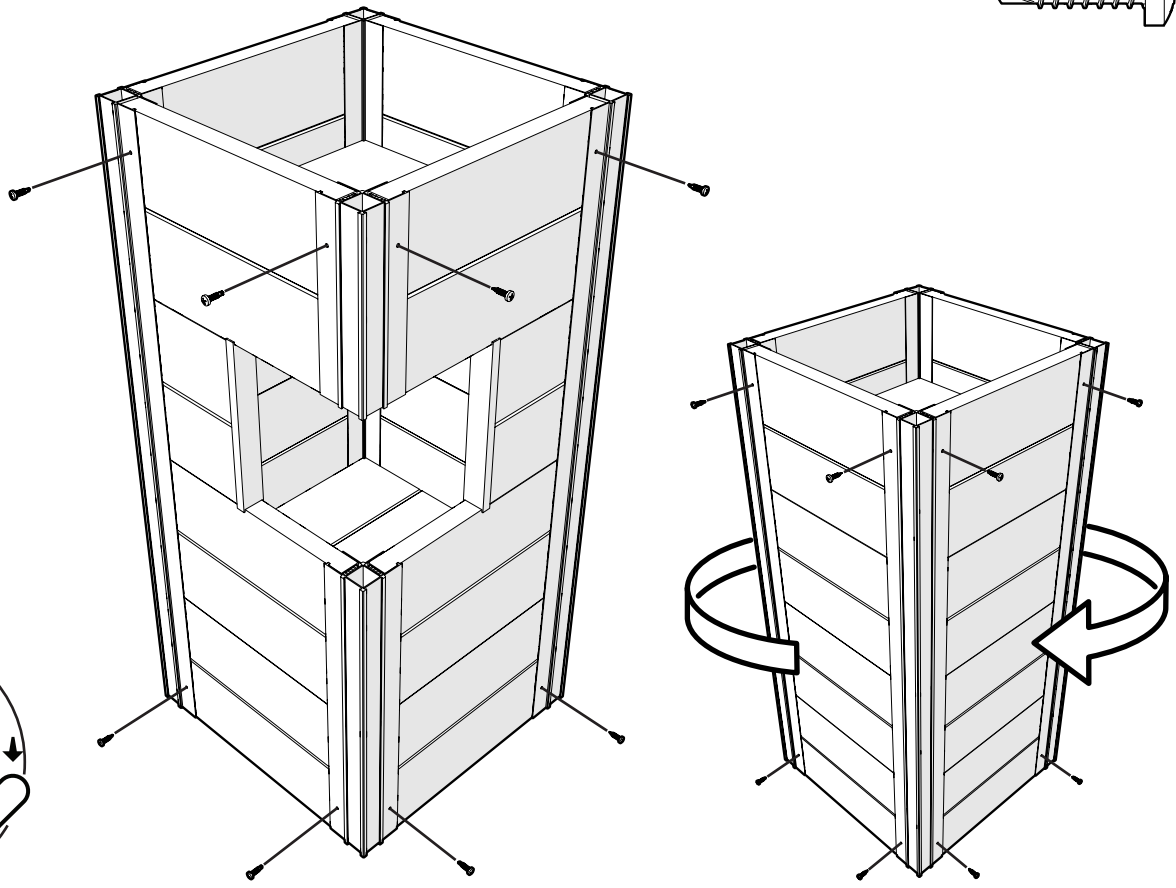

PHILIPS #2



10

16003 - x10 