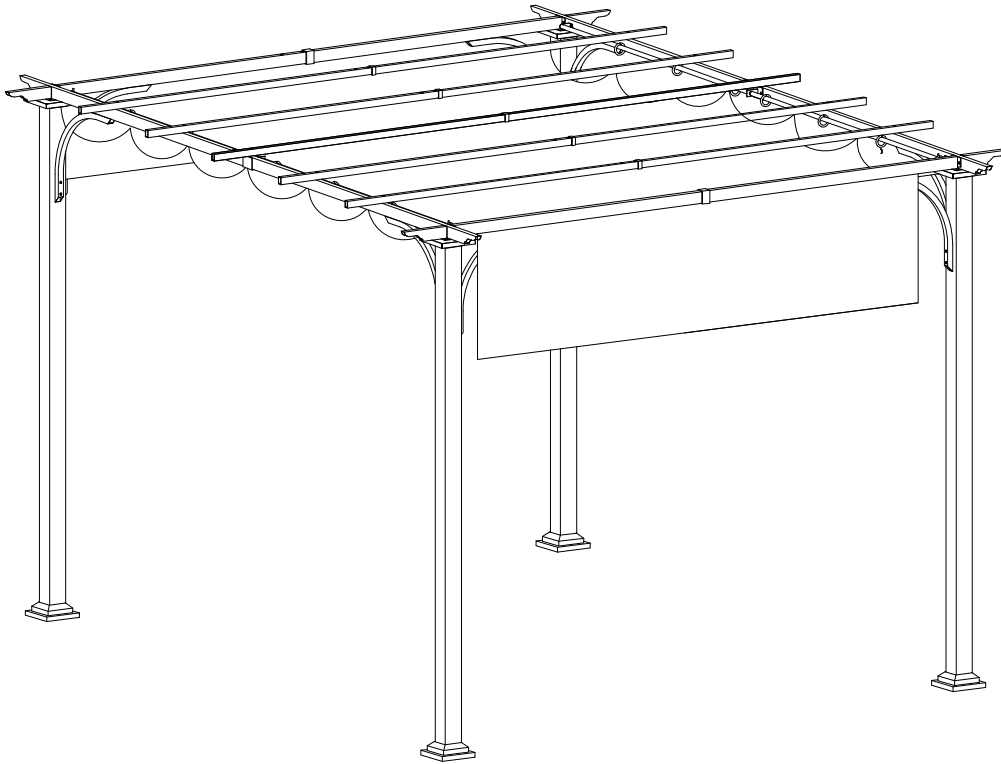


**ITEM NO.: A106005600**



**WE HAVE YOU IN MIND, LET US SERVE YOU!**

Questions? Issues?

**CONTACT US**

24 hours / 7 days a week

 Warranty Parts

[www.sunjoyonline.com](http://www.sunjoyonline.com)




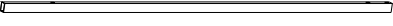
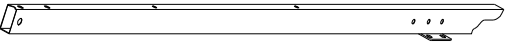

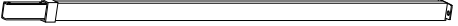
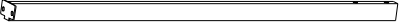



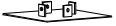





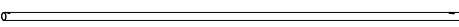

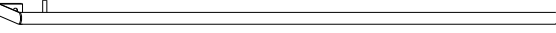
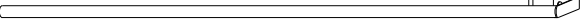
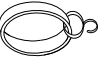

[customer.care@sunjoygroup.com](mailto:customer.care@sunjoygroup.com)

Toll Free



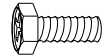
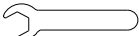


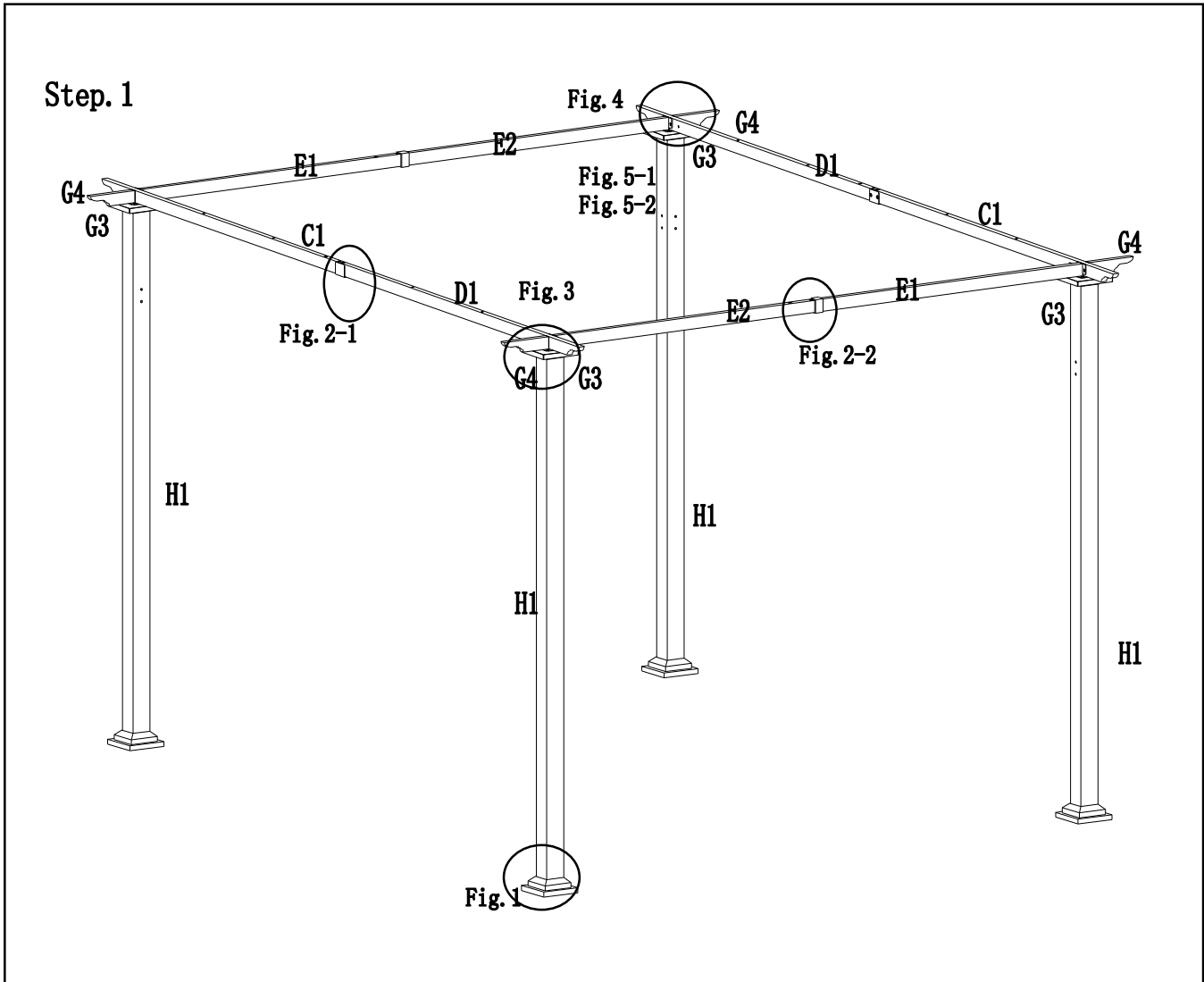
1-(866)-578-6569

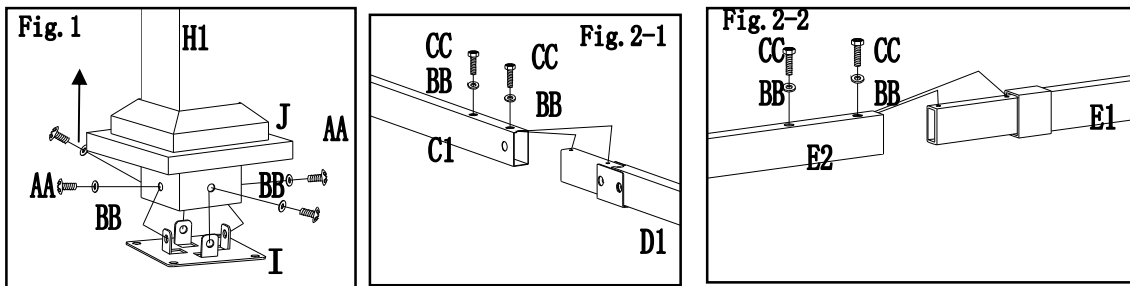
## Parts List

Top beam 1	A1	P000601292	5	
Top beam 2	A2	P000601293	5	
Long side beam (1)	C1	P000400859	2	
Long side beam (2)	D1	P000400858	2	
Short side beam 1	E1	P000400856	2	
Short side beam 2	E2	P000400857	2	
Conner 1	G3	P000300084	4	
Decorate tube	G4	P005600297	4	
Post	H1	P000200447	4	
Stake	I	P006100162	4	
Stake cover	J	P000100314	4	
Arc support	K1	P005000393	8	
Canopy rod 1	M3	P005700635	6	
Canopy rod 2	M4	P005700636	6	
Canopy rod 3	M5	P005700637	2	
Canopy rod 4	M6	P005700638	2	
Rail connector	N	P000501119	2	
Rail beam 1	O1	P005700633	2	
Rail beam 2	O2	P005700634	2	
Ring	P	P005100233	16	
Canopy	Q	P001100521	2	

**Hardware Pack 1**

AA	M6*15 bolt	H010110016	16PCS	
BB	M6 washer	H050010023	52PCS	
CC	M6*20 bolt	H010020011	36PCS	
Z	M6 Wrench	H090010009	1 PC	

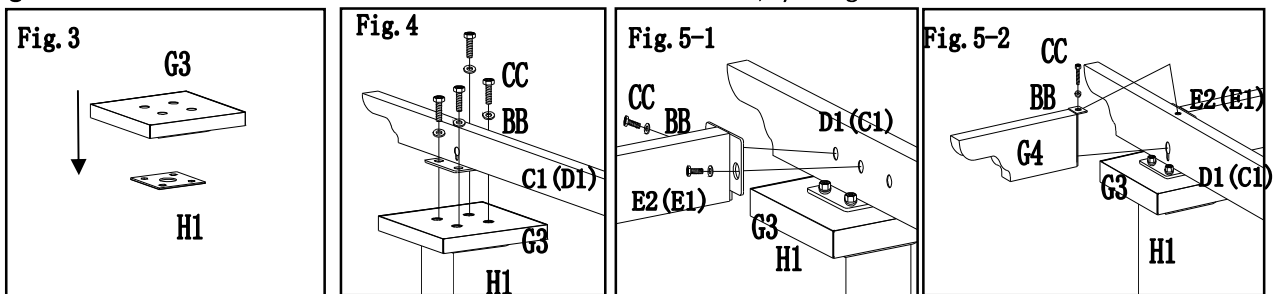




**Fig.1:**Put the stake cover (I) through the post (H1), up the stake cover(J), then attach stake(I) to post bottom (H1) , fasten by using bolt (AA) and washer (BB) .

**Fig.2-1:** Attach long side beam 1 (C1) to long side beam2 (D1) , By using bolt (CC) and washer (BB) .

**Fig.2-2:** Attach short side beam 1 (E1) to short side beam2 (E2) ,by using bolt (CC) and washer (BB) .


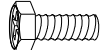
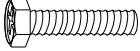


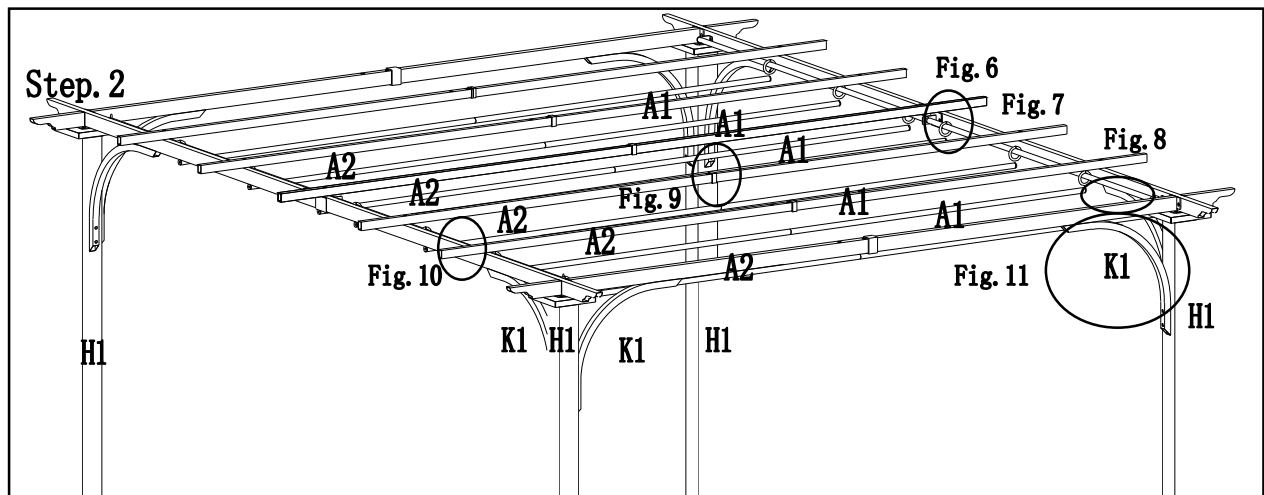
**Fig.4:** Attach corner (G3) to top of post (H1) .

**Fig.5-1:**Attached long side beam (C1、 D1) to top of post (H1), then fix by using bolt (CC) and washer (BB) .

**Fig.5-2:**Attach decorate tube (G4) to long side beam (D1、 C1), then fix by using bolt (CC) and washer (BB) .

### Hardware Pack 2

BB	M6 Washer	H050010023	60PCS	
CC	M6*20 Bolt	H010020012	18	
DD	M6*40 Bolt	H010020022	42	



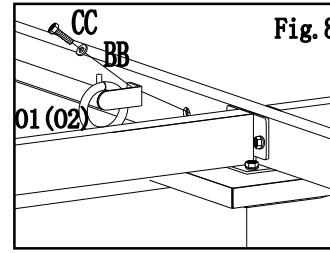
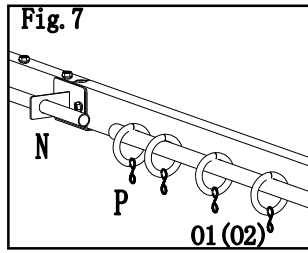
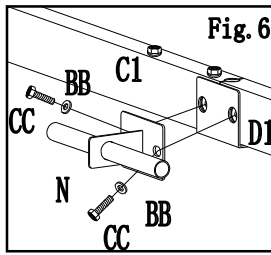


Fig.6:Attach rail connector ( N ) to long side beam ( C1、 D1 ) by using bolt ( CC ) and washer ( BB ) .

Fig.7:Put ring ( P ) through rail rod ( O1、 O2 ),then attach rail rod ( O1、 O2 ) to rail connector ( N )。

Fig.8:Fix rail rod ( O1、 O2 ) to long side beam ( C1、 D1 ) , by using bolt ( CC ) and washer ( BB )。

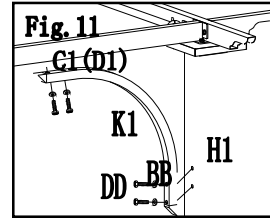
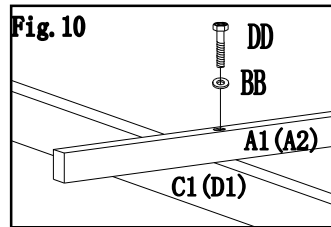
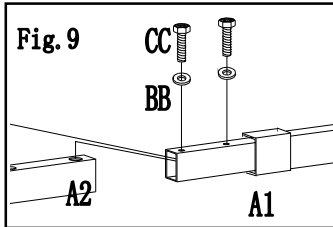


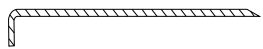


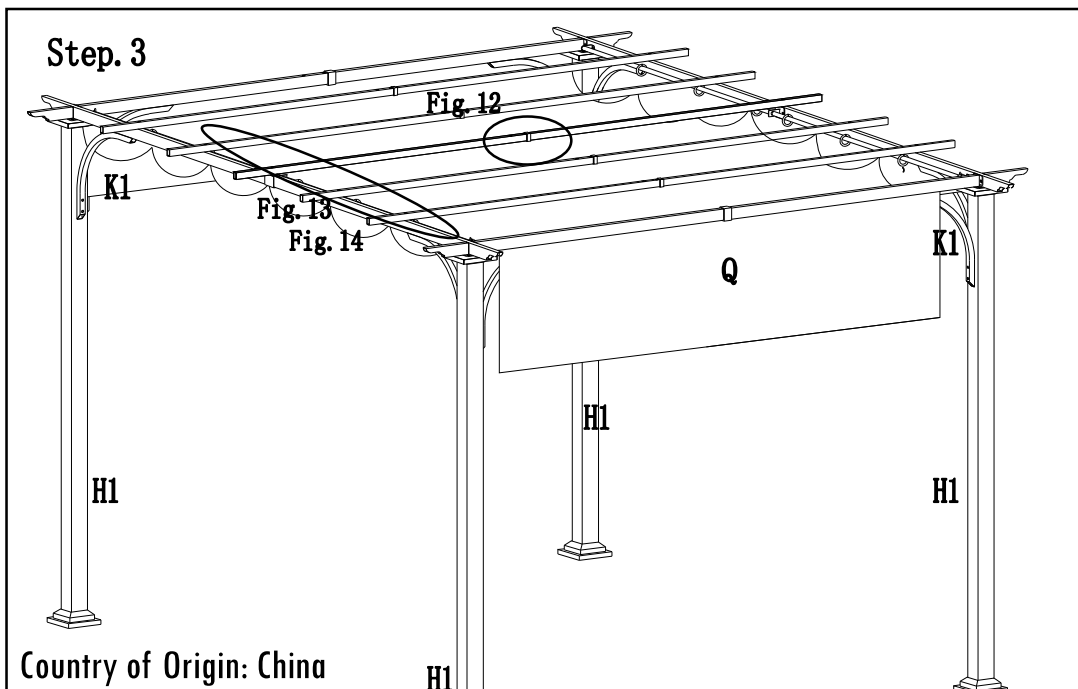
Fig.9: Attach top beam 1 ( A1 ) to top beam 2 ( A2 ) , fix by using bolt ( CC ) and washer ( BB )。

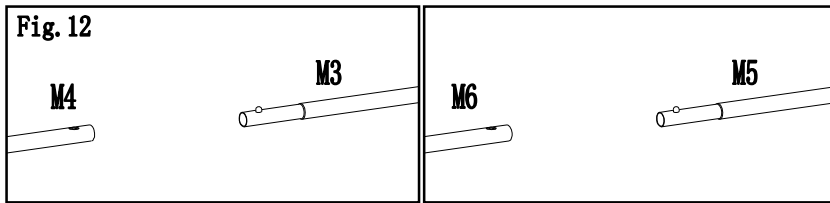
Fig.10: Fix assembled top beam(A1、 A2) to assembled long side beam ( C1、 D1 ) ,by using bolt ( DD ) and washer ( BB )。

Fig.11:Attach art support(K1) to post (H1) and beam (C1,D1,E1,E2), fix by using bolt (DD) and Washer(BB).

### Hardware Pack 3

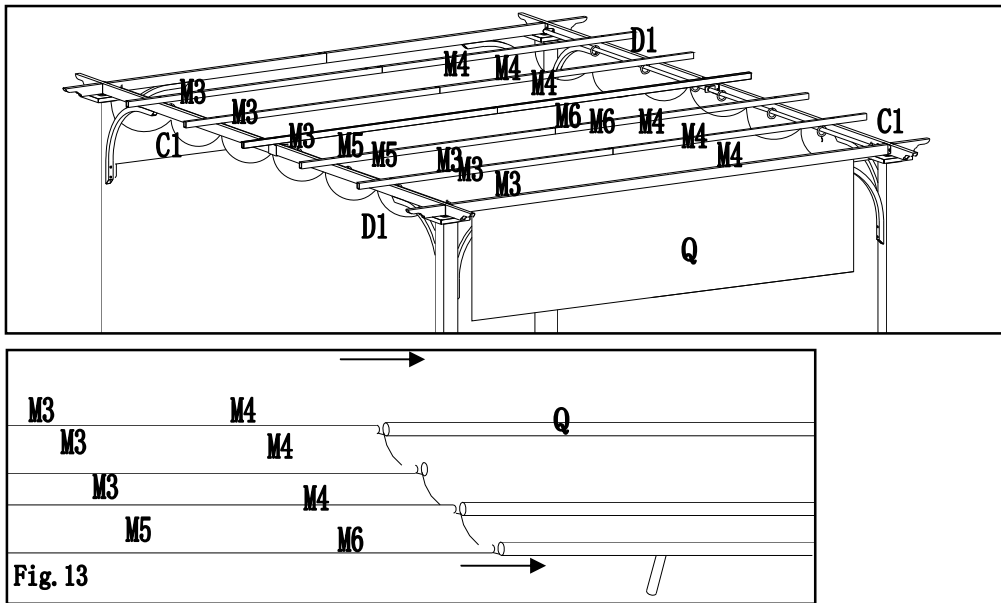
BB	M6 Washer	H050010023	16PCS	
EE	M6*15 bolt	H010110016	16 PCS	
FF	Φ 6*230 floor stake	H070010008	8 PCS	



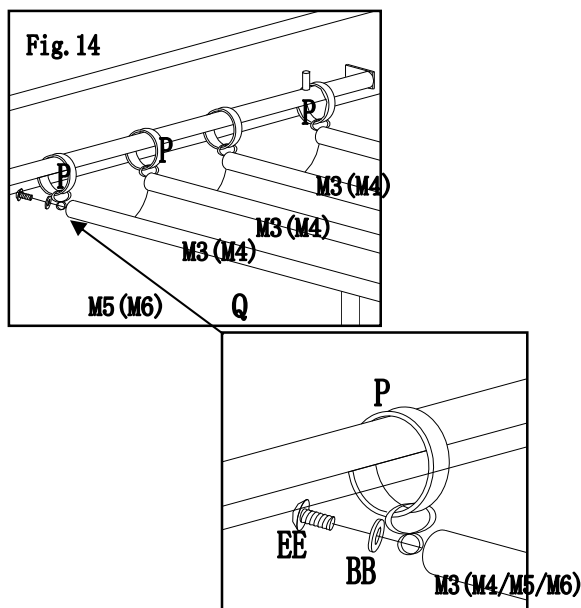


**Fig.12:** Insert canopy rod 1(M3)into canopy rod 2(M4),(repeat step,insert canopy rod3(M5)into canopy rod 4 (M6) .

Below graph presents the assembly detail for beam (M3,M4,M5,M6)

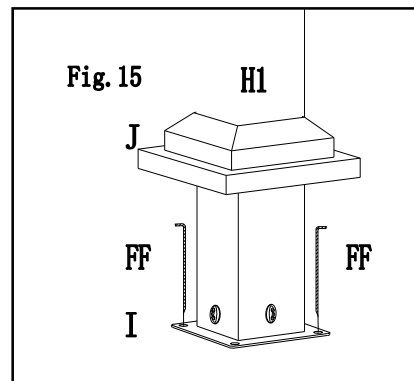


**Fig.13:**Insert canopy rod to the hold of canopy (Q)。(Notes: Insert canopy rod (M5、M6) to the side of handle。)



**Fig.14:**Fix the assembled canopy (Q) to ring (P) by using bolt (EE) and washer (BB).

(Note: Place the side with handle to middle of Pergola)



**Fig.15:**Fix the assembled gazebo on ground by using floor stake(FF).

## Care and Maintenance

- Our steel components for garden accessories and furniture are treated with rust inhibiting paint that protects it from rusting. However, due to the nature of steel, surface oxidation (rusting) will occur once these protective coatings are scratched. This is not a defect and thus not covered by the warranty.
- To minimize this condition, we recommend care when assembling & handling the product to prevent scratching the paint. Should any scratching or damage occur, we recommend immediate touch-up with rust inhibiting paint.
- Surface rust can also be easily removed with a very light application of common cooking oil. If surface oxidation (rusting) occurs and if no measure is taken to prevent this, the oxidation may start dripping on to deck or patio and caused damaging stains, which may be difficult to remove. This can be prevented if the above-mentioned measures are taken to keep the product from oxidizing.
- Use damp cloth to wipe off the stains as quickly as possible.
- If necessary, wash with a mild solution of soap and water; rinse thoroughly and dry completely.
- Periodically check and ensure that all bolts are well-tighten during use

## Limited Manufacturer's Warranty

Sunjoy Group warrants to the original purchaser that this item is free from defects in workmanship and materials for a period of **1 year** from the date of purchase, provided the item was factory-sealed at the time of purchase and is maintained with care and used only for personal, residential purposes. Should any manufacturing defect arise within this warranty period, Sunjoy Group will replace (at our option) any defective merchandise or parts upon proof of purchase; however, transportation and delivery costs, as well as payments to a third party for assembly or disassembly of the item, remain the responsibility of the purchaser. A purchaser of an "open box," previously-returned, or "clearance" item, as well as original purchasers outside of the warranty period, may obtain replacement parts from Sunjoy Group for products in current production, at nominal cost.

## Exclusions:

Items used for commercial, contract, or other non-residential purposes, or items damaged due to acts of nature, vandalism, misuse, or improper assembly are not covered. Corrosion or rusting of hardware is not covered. Proof of purchase (dated register receipt) is required for warranty claims. Warranty is to the original purchaser and is non-transferable. Any replacement of warranted items will be in the original style and color, or a similar style and color if the original is unavailable or has been discontinued. As some states do not allow exclusions or limitations on an implied warranty, the above exclusions and limitations may not apply. This warranty gives you specific rights, and you may also have other rights, which vary from state to state.