

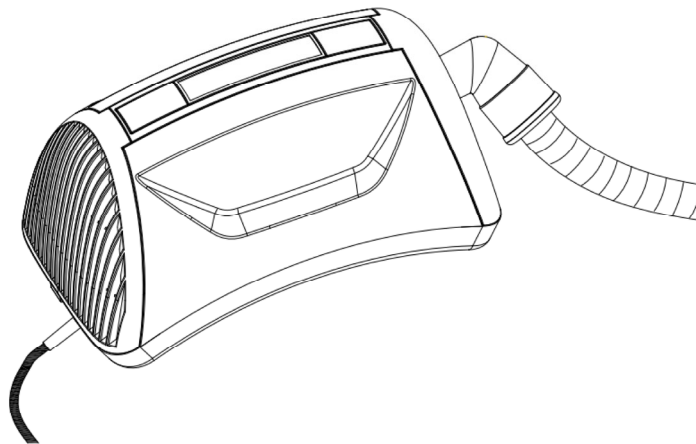

**ERGO LITE HIP VACUUM
OWNER'S MANUAL**

**Model: VACHV1
120V, 1200W**



Atrix

1350 Larc Industrial Blvd.

Burnsville, MN 55337

www.atrix.com

sales@atrix.com

Telephone: 952.894.6154

Toll Free Telephone: 800.222.6154

Fax: 952.894.6256

IMPORTANT SAFETY INSTRUCTIONS

When using an electrical appliance, basic precautions should always be followed, including the following:



READ ALL INSTRUCTIONS BEFORE USING APPLIANCE

WARNING:

TO REDUCE THE RISK OF FIRE, ELECTRICAL SHOCK OR INJURY:

1. Do not leave appliance when plugged in. Unplug from outlet when not in use and before servicing.
2. Electrical shock may occur if used outdoors or on wet surfaces.
3. Do not allow to be used as a toy. Close attention is necessary when used by or near children.
4. Use only as described in this manual. Use only manufacturer's recommended instructions.
5. Do not use with damaged cord or plug. If appliance is not working as it should, has been dropped, damaged, left outdoors, or dropped into water, return it to Atrix International.
6. Do not pull or carry by cord, use cord as a handle, close a door on cord, or pull cord around sharp edges of corners. Do not run appliance over cord. Keep cord away from heated surfaces.
7. Do not unplug by pulling on cord. To unplug, grasp plug, not the cord.
8. Do not handle plug or appliance with wet hands.
9. Do not put any object into openings. Do not use with any opening blocked; keep free of dust, lint, hair, and anything that may reduce airflow.
10. Keep hair, loose clothing, fingers and all body parts away from openings and moving parts.
11. Do not pick up anything that is burning or smoking such as cigarettes, matches or hot ashes.
12. Do not use without filter in place.
13. Turn off all controls before unplugging.
14. Use extra care when cleaning on stairs.
15. Do not use to pick up any liquids, including flammable or combustible liquids such as gasoline or use in areas where they may be present.
16. Connect to a properly grounded outlet only.
17. This appliance is not intended for use by persons (including children) with reduced physical, sensory or mental capabilities, or lack of experience and knowledge, unless they have been given supervision or instruction concerning use of the appliance by a person responsible for their safety. Children should be supervised to ensure that they do not play with the appliance.

SAVE THESE INSTRUCTIONS!

GETTING TO KNOW YOUR VACUUM CLEANER

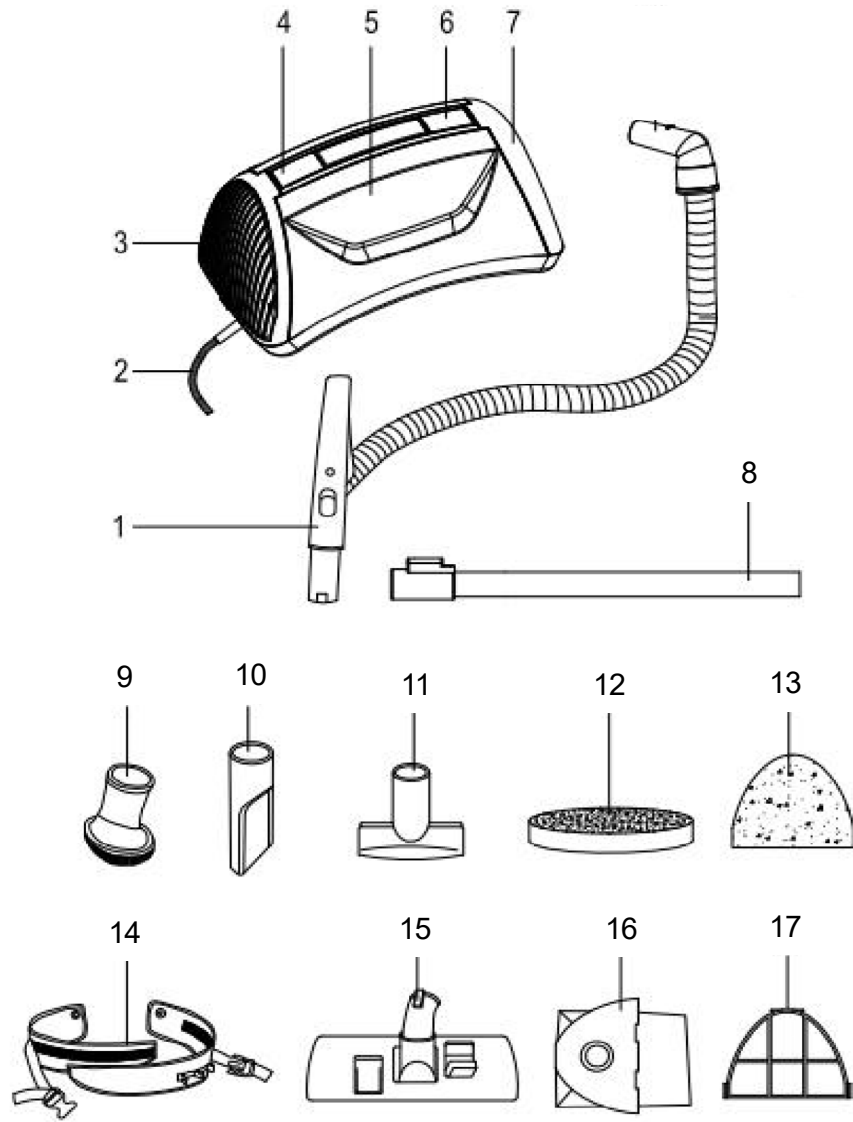

1. Flexible-Hose w/Handle	10. Crevice tool
2. Power-cord	11. Furniture nozzle
3. Exhaust cover	12. Premotor filter (foam)
4. Release button for exhaust cover	13. Exhaust filters - x2 (included: 1 foam and 1 cloth)
5. Main body	14. Waist belt
6. Release button for air-inlet cover	15. Floor brush
7. Hepa Dust bag cover	16. Hepa dust bag
8. Extension wand	17. Rubber exhaust filter gasket
9. Oval brush	

OPERATING INSTRUCTIONS

1. Hepa Dust bag installation:

- a. Open the triangular shaped Hepa dust bag cover by gently pressing one end of the locking bar to release the locking mechanism.
- b. Grasp the cover in your hand, lifting the upper corners of the cover away from the vacuum housing.
- c. Slide the bottom edge of the cover away so the hinges on the cover slip out of the housing.
- d. Inside the dust bag cavity, a round foam filter helps to protect the motor. Be sure this filter is in place prior to installation of the Hepa dust bag.
- e. Gently unfold the new Hepa dust bag. The upper corner of the Hepa dust bag should be slid in so they do not interfere with the cardboard plate resting securely on the housing.
- f. Ease the Hepa dust bag into the cavity, placing the cardboard plate onto the exterior lip of the cavity, make sure that the cardboard plate is fitted behind the two small clips on the exterior rim.

NOTE: The triangular shaped cardboard plate must be placed evenly on the exterior rim of the housing for the dust bag cover to be properly installed.

- g. Then grasp the cover in your hand and insert the lower cover hinges into the indentations. Be sure the Hepa dust bag cardboard plate is resting evenly on the rim of the cavity. Close the cover and make certain it clicks into place.

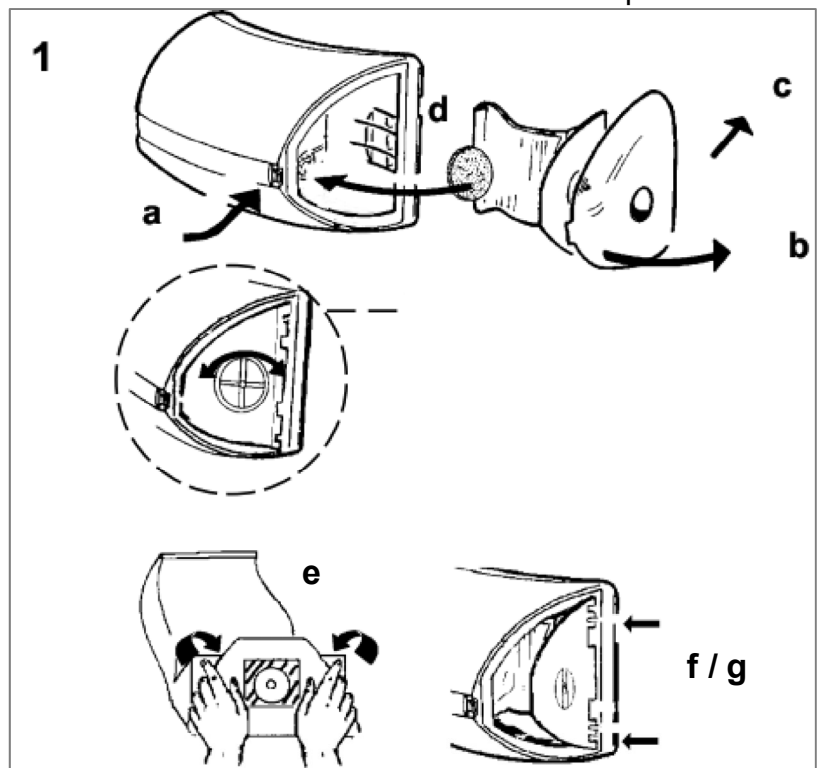

2. The belt is designed to hold the vacuum securely around your waist while working.

Soft Belt:

2a) Wrap the belt around your waist. Adjust it to the desired size by fitting the two Velcro belt bands together.

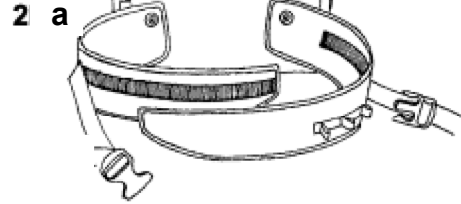

Belt Locking Clip:

2b) Then insert the toothed connector into the belt buckle until it snaps into place. To disconnect the belt when work is finished, gently squeeze the outer dips together, and pull connector out of belt buckle.

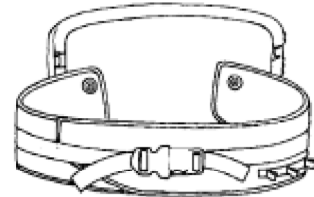

To adjust the belt locking clip for individual comfort-

Smaller: Pull the loose end of the nylon belt until adjusted to desired size.

Larger: Hold the belt locking clip in one hand and slide the nylon belt until a loop is formed. Pull the belt locking clip to adjust the slack in nylon belt.

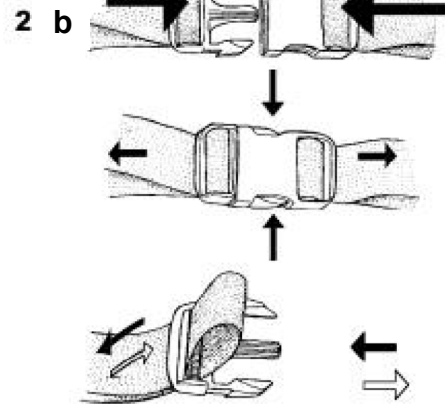

3. Hose connection:

Note: The flexible hose should be connected to the vacuum before strapping the unit to your hips.

Fit the hook on the hose adapter in the recess of the hose opening on the machine. Press and turn about one half-turn to ensure a secure fit.

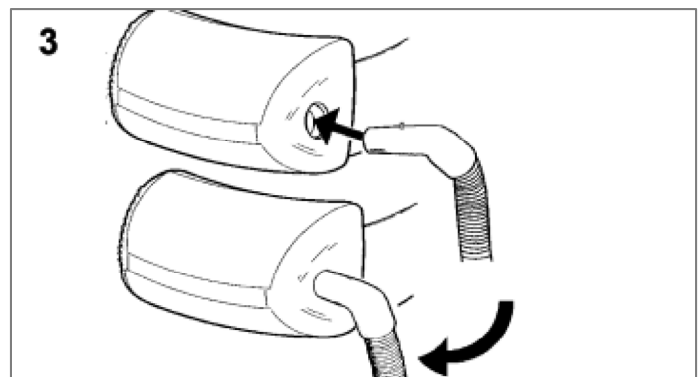

4. Wand assembly:

Insert the handle into the extension wand, then insert the wand into the floor brush or accessory tool.

Adjust the length of the extension wand by pressing the slide button to adjust the wand length.

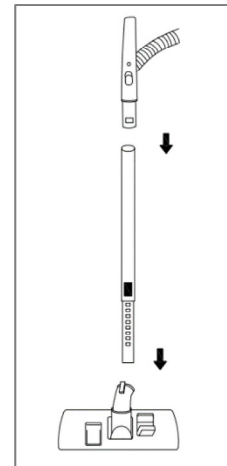

5. Tools:

Floor Brush - Can be used on carpets and or hard surfaces. The tool allows you to retract the bristle brushes when being used on the carpet or rugs but can be extended when being used on wood or tile surfaces.

Crevice Tool - Use for vent covers, crevices, corners, baseboards, and between cushions.

Oval Brush - The oval dust brush is used for furniture and between cushions, vent covers, crevices, corners, and baseboards.

Furniture Nozzle - The furniture nozzle is designed to clean furniture and rugs.

6. Exhaust Filters:

The exhaust cover is easily removed for filter changes:

- Release the locking mechanism by gently pressing down on one end of the locking bar to release the locking mechanism.
- Grasp the cover in your hand.
- Ease the upper corner away from the vacuum housing.
- Slide the bottom edge of the cover away so the hinges on the bottom edge of the cover slip out of the housing.

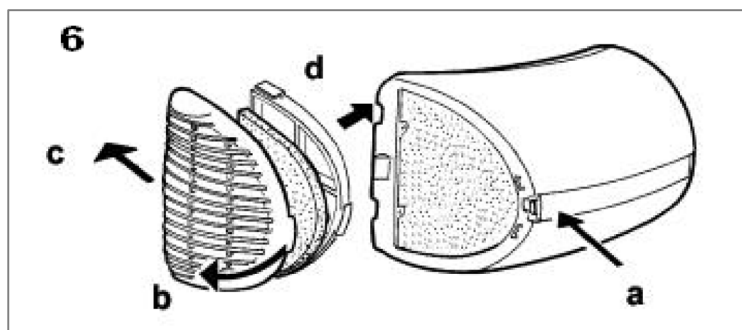

- Remove rubber gasket and used filters.
- Install the new black foam exhaust filter by placing onto the slits and secure with the rubber gasket. Next, insert the new white cloth exhaust filter over the rubber gasket.
- Then, grasp the cover in your hand and insert the lower cover hinges into the indentations. Be sure the rubber gasket and exhaust filters are resting evenly on the rim of the cavity. Close the cover and make certain it clicks into place.

Atrix ERGO lite Hip Vacuum WARRANTY INFORMATION

Warranty/Service Information: For warranty service information, please contact Atrix or your local Atrix distributor.

Atrix ERGO lite Hip Vacuum Limited Warranty: To the original user purchasing the Atrix ERGO lite Hip Vacuum, Atrix warrants that the vacuum will be free of defects in material and manufacture for a period of one (1) year from the date of purchase. Should any failure to conform to this warranty appear within this period, Atrix will, at its option, repair or replace the defective product. It is the user's responsibility to return the product, freight prepaid, to Atrix International. These remedies are the user's exclusive remedies for breach of this warranty.

Exclusions to warranty coverage: The above warranty will not apply to any special configurations or to any unit that have been modified, or damaged by negligence, misuse, accident or failure to follow Atrix's Instruction manual. Consumable supplies, such as filters, accessories, and motor brushes are not covered by this warranty.

Disclaimer of Warranty: EXCEPT FOR THE IMPLIED WARRANTIES OF TITLE AND AGAINST PATENT INFRINGEMENT, ATRIX MAKES NO OTHER WARRANTIES WITH RESPECT TO THE ATRIX BACKPACK VACUUM CLEANER, EXPRESS OR IMPLIED, INCLUDING BUT NOT LIMITED TO ANY IMPLIED WARRANTY OF MERCHANTABILITY OR FITNESS FOR A PARTICULAR PURPOSE.

Limitation of Liability: ATRIX WILL NOT BE LIABLE UNDER ANY CIRCUMSTANCES FOR ANY COINCIDENTAL, SPECIAL, OR CONSEQUENTIAL DAMAGES OR ECONOMICAL LOSS, BASED UPON BREACH OF WARRANTY, BREACH OF CONTRACT, NEGLIGENCE, STRICT LIABILITY IN TORT OR ANY OTHER LEGAL THEORY, EVEN IF ATRIX HAS BEEN ADVISED OF THE POSSIBILITY OF SUCH DAMAGES INCLUDING, BUT NOT LIMITED TO LOSS OF PROFITS, REVENUE, EQUIPMENT USE, DATA OR INFORMATION OF ANY KIND. THE LIABILITY OF ATRIX SHALL NOT UNDER ANY CIRCUMSTANCE, EXCEPT AS EXPRESSLY PROVIDED HEREIN, EXCEED THE PRICE OF THE ATRIX BACKPACK VACUUM.

To Register your Warranty Visit:
www.atrix.com