



# A POWER

## INVERTER GENERATOR

### Owner's Manual

Models: SUA2000iA and SC2000iA



**SAVE THIS MANUAL FOR FUTURE REFERENCE**

**IMPORTANT SAFETY INSTRUCTIONS ARE INCLUDED IN THIS MANUAL**

**CUSTOMER SERVICE**  
**SERVICE CLIENTELE**  
**SERVICIO AL CLIENTE**  
**1-855-888-3598**

**A-iPOWER Corp.**  
**1477 E. Cedar St. #B,**  
**Ontario, CA 91761**  
**U.S.A.**  
**[www.a-ipower.com](http://www.a-ipower.com)**



# **A-iPOWER**

---

## **INVERTER GENERATOR** **Owner's Manual**



**SAVE THIS MANUAL FOR FUTURE REFERENCE**

**IMPORTANT SAFETY INSTRUCTIONS ARE INCLUDED IN THIS MANUAL**

**CUSTOMER SERVICE**  
**SERVICE CLIENTELE**  
**SERVICIO AL CLIENTE**  
**1-855-888-3598**

**A-iPOWER Corp.**  
**1477 E. Cedar St. #B,**  
**Ontario, CA 91761**  
**U.S.A.**  
**[www.a-ipower.com](http://www.a-ipower.com)**

# **We Appreciate Your Business.**

*Thank you and congratulations on choosing A-IPOWER.*

This Operating Manual has been designed to instruct you on the correct use and operation of your A-IPOWER product. Your satisfaction with this product and its safe operation is our ultimate concern. Therefore please take the time to read the entire manual, especially the Safety Precautions. They will help you to avoid potential hazards that may exist when working with this product.



## **WARNING!**

***READ AND UNDERSTAND ALL SAFETY PRECAUTIONS IN THIS MANUAL BEFORE OPERATING. FAILURE TO COMPLY WITH INSTRUCTIONS IN THIS MANUAL COULD RESULT IN PERSONAL INJURY, PROPERTY DAMAGE, AND/ OR VOIDING OF YOUR WARRANTY. A-IPOWER WILL NOT BE LIABLE FOR ANY DAMAGES DUE TO FAILURE TO FOLLOW THESE INSTRUCTIONS. CUSTOMER SERVICE: 1-855-888-3598, WWW.A-IPOWER.COM***

# Table of Contents

<b>SECTION 1: SAFETY INSTRUCTIONS AND WARNINGS</b> .....	1
<b>SECTION 2: CONTROLS AND FEATURES</b> .....	9
2.1 Generator .....	9
2.2 Control Panel .....	10
2.3 Control Functions .....	11
<b>SECTION 3: GETTING STARTED</b> .....	15
3.1 Unpacking the Generator .....	15
3.2 Adding Engine Oil .....	15
3.3 Adding Fuel .....	17
3.4 Starting the Engine .....	18
3.5 Stopping the Engine .....	20
<b>SECTION 4: ELECTRICAL CONNECTION</b> .....	21
4.1 Capacity .....	21
4.2 Power Maintenance .....	21
4.3 Connecting Electrical Loads .....	21
4.4 Parallel Connection with 2 generator .....	22
4.5 Battery Charging .....	25
4.6 Wattage Reference Guide .....	26
<b>SECTION 5: MAINTENANCE</b> .....	28
5.1 Periodic Maintenance .....	28
5.2 Spark Plug Maintenance .....	29
5.3 Engine Oil Replacement .....	30
5.4 Air Filter Maintenance .....	31
5.5 Muffler Screen & Spark Arrestor Maintenance .....	32
5.6 Fuel Filter Maintenance .....	33
<b>SECTION 6: STORAGE</b> .....	34
6.1 Long Term Storage .....	34
<b>SECTION 7: TROUBLESHOOTING AND SPECIFICATIONS</b> .....	36
7.1 Troubleshooting Diagram .....	36
7.2 Fuel Filter Maintenance .....	37
7.3 Specifications .....	38
<b>SECTION 8: WARRANTIES</b> .....	39

# **SECTION 1: SAFETY INSTRUCTIONS AND WARNINGS**

 **PROP 65 WARNING**

**For California Residents:**

This product contains chemicals known to the State of California to cause cancer or birth defects and other reproductive harm.

 **Read this manual carefully before operating this generator. This manual should stay with this generator if it is sold.**

## **INTRODUCTION**

This Operating Manual has been designed to instruct you on the correct operation of your A-IPOWER product. Your satisfaction with this product and its safe operation is our ultimate concern. Therefore please take the time to read the entire manual, especially the Safety Precautions. They will help you to avoid potential hazards that may exist when working with this product.

## IMPORTANT MANUAL INFORMATION

Important information is distinguished in this manual by the following notes.



### Symbol Usage

**This manual contains important information that you need to know and understand in order to assure YOUR SAFETY and PROPER OPERATION OF EQUIPMENT. The following symbols help you recognize this information. Please read the manual and pay attention to these sections.**



**WARNING INDICATE A CERTAINTY OR STRONG POSSIBILITY OF PERSONAL INJURY OR DEATH IF INSTRUCTIONS ARE NOT FOLLOWED.**

### **NOTICE**

**CAUTION INDICATES A POSSIBILITY DAMAGE TO THE PRODUCTS IF INSTRUCTIONS ARE NOT FOLLOWED PROPERLY.**

### TIPS

TIPS GIVE HELPFUL INFORMATION



**PLEASE READ AND UNDERSTAND THIS MANUAL COMPLETELY BEFORE OPERATING THE MACHINE**

### TIPS

A-IPOWER continually seeks advancements in product design and quality.

Therefore, wherein this manual contains the most current product information available at the time of printing, there may be minor variances between your product and this manual. If there is any question concerning this manual, please consult a A-IPOWER dealer.

This manual should be considered a permanent part of this product and should remain with this product when resold.

Product and specifications are subject to change without notice.

## **SAFETY INFORMATION**

### **FUEL IS HIGHLY FLAMMABLE AND POISONOUS**

- Always turn off the engine when refueling.
- Never refuel while smoking or in the vicinity of an open flame.
- Take care not to spill any fuel on the engine or muffler when refueling.
- If you swallow any fuel, inhale fuel vapor, or allow any to get in your eye(s), see your doctor immediately. If any fuel spills on your skin or clothing, immediately wash with soap and water and change your clothes.
- When operating or transporting the machine, be sure it is kept upright. If it tilts, fuel may leak from the carburetor or fuel tank.

### **EXHAUST FUMES ARE POISONOUS**

- Never operate this product in a closed area or it may cause unconsciousness and death within a short time. Always operate this product in a well ventilated outdoor area.

### **ENGINE AND MUFFLER MAY BE HOT**

- When operating the generator place in a safe area away from pedestrians or children.
- Avoid placing any flammable materials near the exhaust outlet during operation.



- Keep the generator at least 1m(3 ft)from buildings or other equipment, or the product may overheat.
- Do not operate the product with a dust cover, or other objects covering it.
- When covering the generator, be sure to do so only after the engine and muffler have completely cooled down.
- Be sure to carry the generator only by its carrying handles.
- Do not place any obstacles on the generator.

## **TO PREVENT ELECTRIC SHOCK**

- Never operate the product in rain or snow.
- Never touch the generator with wet hands or electrical shock can occur.

## GROUNDING

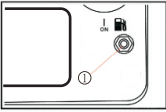

- Properly ground generator to prevent electric shock.
- Connect the ground terminal of the generator to the the ground electrode buried in the ground.

## WARNING NOTES

- Failure to properly ground the generator can result in electric shock.
- Be sure to always comply with electric loads.

## CONNECTION



Before the generator can be connected to a building's electrical system , a licensed electrician must install an isolation (transfer)switch in the building's main fuse box. The switch is the connection point for generator power and allows selection of generator or main line power to the building .This will prevent the generator from charging the main power line (back feeding)when the main power supply has failed or has been turned off for line repair. backfeeding can electrocute or injure line maintenance personnel. Also , generator and building electrical system damage can occur when normal operating power returns if unit is used without an



Always use proper approved electrical cords. Be sure to comply with all electric codes.  
Do not use electrical cords that are worn or damaged.  
Always use GFCI(ground fault circuit interruptor) for damp locations.  
Always use proper approved transfer switch to isolate generator from the electric panel.

# LOCATION OF IMPORTANT LABELS



Please read the following labels carefully before operating this product.

**TIP**

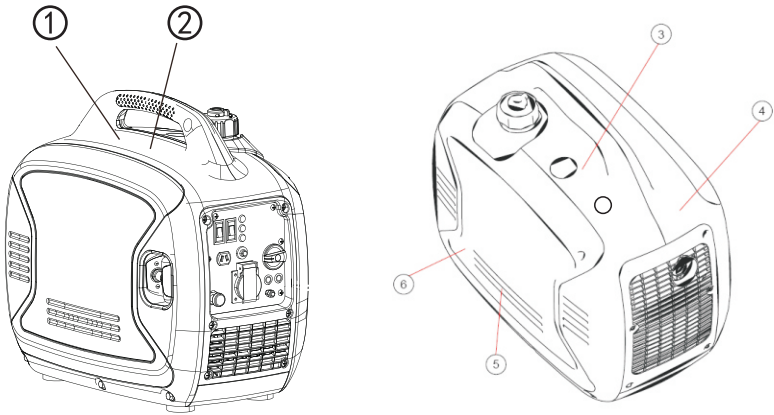
Maintain or replace safety and instruction labels, as necessary. For customer service, call 1-855-888-3598.

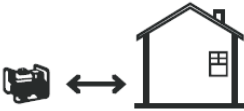

①

<b>⚠ DANGER</b>	
<b>Using a generator indoors WILL KILL YOU IN MINUTES.</b> Exhaust contains carbon monoxide, a poison gas you cannot see or smell.	
 	
<b>NEVER</b> use in the home or in partly enclosed areas such as garages.	<b>ONLY</b> use outdoors and far from open windows, doors, and vents.

②

## **⚠ WARNING**

- Read the owner's manual and all labels before operating.
- Only operate in well-ventilated areas. Exhaust gas contains poisonous carbon monoxide.
- Stop engine before refueling. Check for spilled fuel or fuel leaks.
- Electrocutation can occur if generator is used in rain, snow, or near water. Keep this unit dry at all times
- Do not place a partition or other barrier around the generator while running.
- Do not cover the generator with a box while running.
- Do not place any objects on the generator.
- Do not connect this generator to any building's electrical system.
- Do not operate near flammable materials.

③

### **SPARK PLUG ACCESS**

Use the specified spark plug only :TORCH E5T(E5RTC)

④



# SECTION 2:

## Controls and Features

### 2.1 Generator

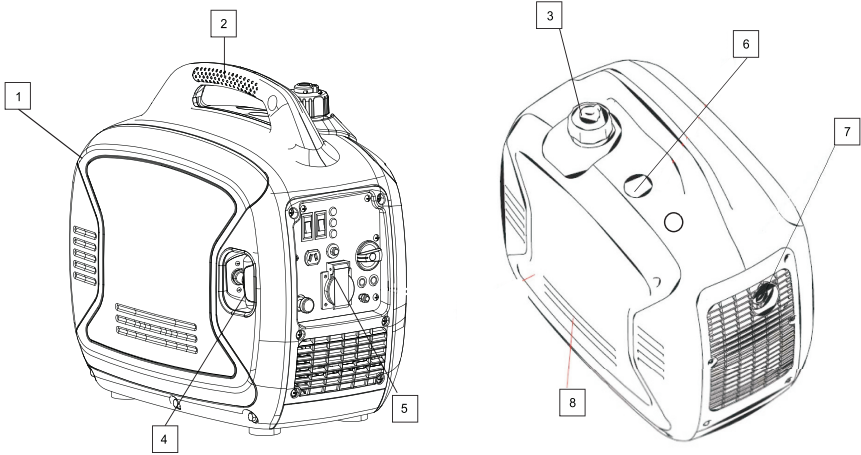

- 1. Muffler
- 2. Carrying handle
- 3. Vented Gas Cap
- 4. Recoil Starter
- 5. Control Panel
- 6. Fuel Gauge
- 7. Exhaust and Spark Arrestor
- 8. Oil filler cap

## 2.2 Control Panel

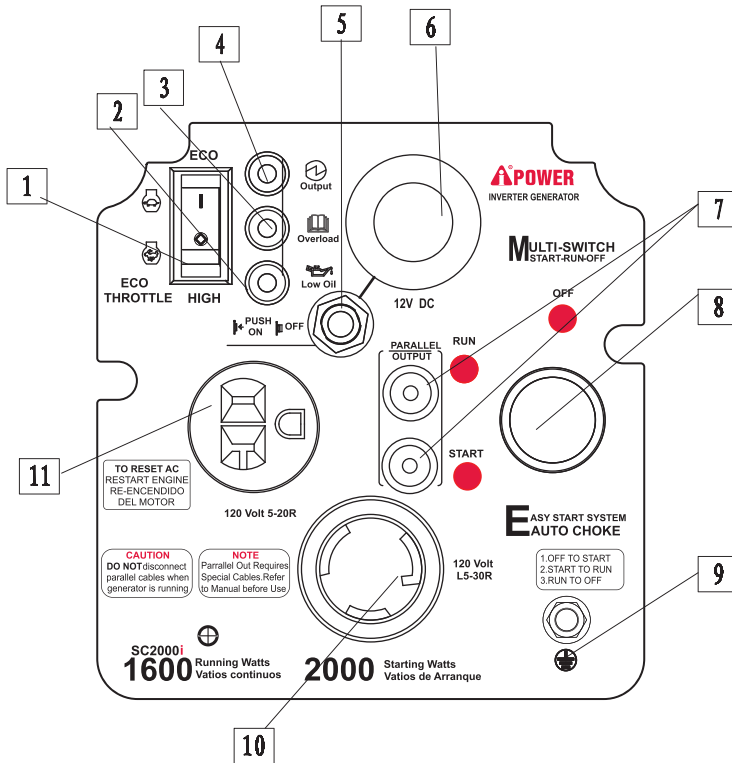

1. Economy Throttle (Black)
2. Low Oil Alarm
3. Overload Alarm
4. Output Indicator
5. 8A DC Circuit Breaker
6. 12V DC Output
7. Parallel Output
8. Multi-switch
9. Ground Terminal
10. 120 Volt L5-30R
11. 120 Volt 5-20R

## 2.3 Control Functions

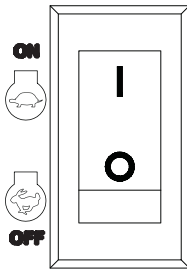

**ECONOMY THROTTLE**



### ECO Throttle

When the Throttle switch is in the “ON” position the throttle controls the engine speed according to the connected electrical load. The results are better fuel consumption and less noise. When the switch is in the “OFF” position the engine runs at 4,500 rpm regardless of the electrical load.

### Note:

*The Throttle must be “OFF” when using electrical devices that require a large starting current, such as a compressor, pump, or refrigerator.*

### LED Indicators

The LED Indicators assist in communicating status and functions of the unit .

#### Output Indicator (Green)

The Output Indicator comes on when the engine starts and produces power.

#### Overload Alarm (Red)

The Overload Alarm comes on when a connected device requires more power than the generator is able to produce,

The Output Indicator (Green) will go off and the Overload Alarm (Red) will stay on, but the engine will continue to run

**CAUTION: Do not overload the generator**

#### Low Oil Alarm (Red)

When the engine oil falls below the required level the Low Oil Alarm will come on and the engine will stop automatically. The engine will not restart until oil is added to the unit to bring it up to the appropriate level.

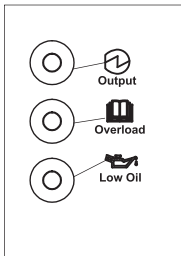

## To Reset the Generator

1. Turn off any connected electric devices and stop the engine.
2. Reduce the total wattage of connected electric devices within the rated output.
3. Use in proper ventilated areas. Maintain at least 3ft of clearance on all sides for adequate cooling.
4. After checking, restart the engine. ( refer to part 3.4 in this manual for how to start).



### **Note:**

*The Overload Alarm may come on for a few seconds when first using electrical devices that require a large starting current, such as a compressor, pump, or refrigerator. This is normal and not a malfunction.*

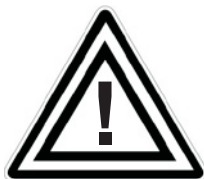

### **Note:**

*When starting the unit, if the Low Oil Alarm light flickers and the engine will not start, you will need to add engine oil before attempting to restart the engine.*



### **Note:**

*Generator should only be operated on a level surface. DO NOT operate the generator on loose ground or obvious inclines. The low oil shutdown feature may be prematurely activated in these cases causing the engine to not start.*

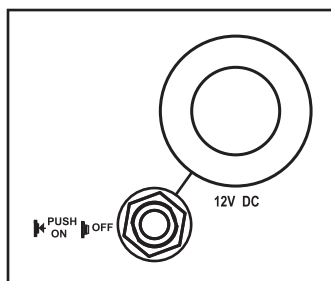

### **12V 8A DC**

The 12V 8A DC Output is provided for battery charging. Follow instructions in the owner's manual for the battery for charging procedures.

### **8A DC Circuit Breaker**

The 8A DC Circuit Breaker turns off automatically if the current exceeds 8A. If the circuit breaker turns "OFF" you will need to push it "in" to turn it "ON" again.



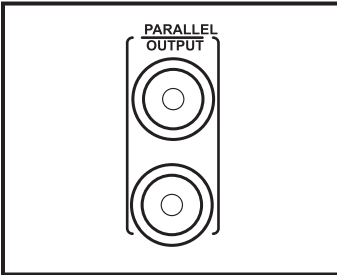

### **Parallel Output**

Two generators can be connected to increase output.

Put parallel wire into the socket first, then start the two greater wattage as the normal process.

Note: put the connection wire into the right Sockets (Please refer to 4.4 for how to connect properly) .

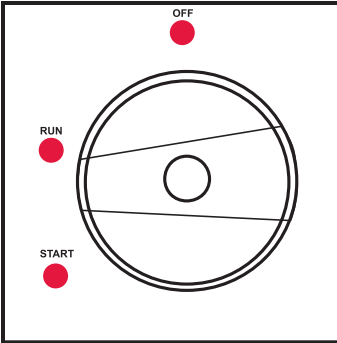

### **Multi-Switch**

The multi-switch control fuel valve, choke and engine switch.

When starting the generator, rotate the multi-switch counter clockwise from OFF to START position, then pull recoil cord quickly to start. After started, rotate the switch to RUN position

#### **NOTE:**

To shut off generator rotate Multi-Switch clockwise to OFF position and hold until generator turns off.

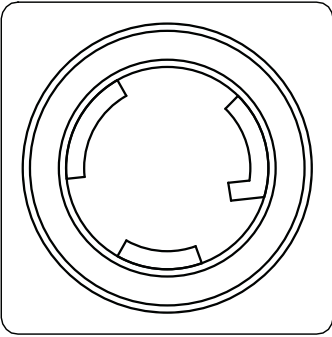

### **120V AC Outlet**

The Outlet is used to power 120V Single Phase 60Hz loads requiring up to 1600W continuous power.

120V AC twist lock receptacle( NEMA LR-30R) may be used to supply electrical power when parallel connection.

**NOTE:**

*When two generators are connected in parallel for greater wattage loads, an RV(NEMA TT-30) adaptor is provided.*

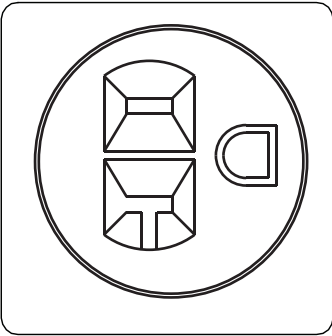

### **120 Volt 5-20R**

The Outlet is used to power 120V Single Phase 60Hz loads requiring up to 1600W continuous power.

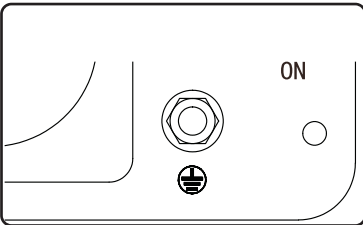

### **Ground Terminal**

Properly ground generator to prevent electrical shock.

Connect the ground terminal of generator to ground electrode buried in the ground.

# SECTION 3:

## Getting Started

### 3.1 Unpack the Generator

Remove the generator from its packaging.



**WARNING!**  
**PACKAGING IS FLAMMABLE!**  
**DO NOT ATTEMPT TO ADD FUEL TO THIS UNIT**  
**BEFORE REMOVING IT FROM PACKAGING.**

Inspect the generator to ensure that no damage has occurred in shipping or handling. If the unit appears to be damaged, DO NOT add fuel or attempt to start the generator. Please call A-IPOWER customer service at 1-855-888-3598

**Check to ensure that you received the following items:**

- SUA2000i 2000W Generator
- 12V Charging Cables
- Parallel output wire
- Oil Funnel
- RV Adaptor

If you did not receive any of the above items, please contact A-IPOWER customer service at 1-855-888-3598

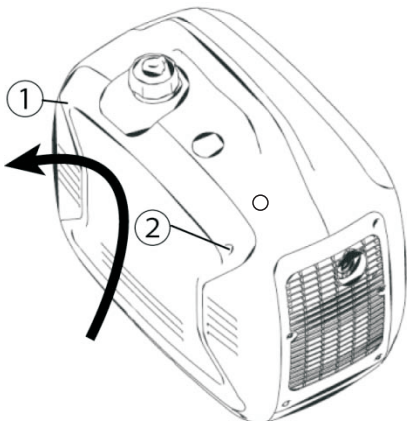

Figure 1

### 3.2 Adding Engine Oil

The generator has been shipped without engine oil.  
DO NOT add fuel or start the engine before adding engine oil.

IN ORDER TO ADD MOTOR OIL YOU WILL NEED TO REMOVE THE SIDE PANEL FROM THE UNIT(Figure1).

Using a #2 Phillips-head screwdriver remove screws ① and ② (seen in figure 1) and lift up and away to remove the side panel.

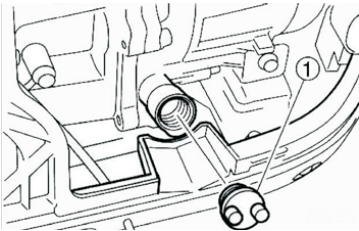

Figure 2

Place the generator on a level surface. DO NOT tilt the generator while adding oil. It can cause you to overfill the oil and/or cause the oil to leak into areas in which it is not intended.

Remove the oil filler cap ① (seen in figure 2)

Using the funnel (provided) fill with 0.42 quart of SAE 10W-30 or 10W-40 (provided) (see figure 3). See figure 4 for proper oil level ①.

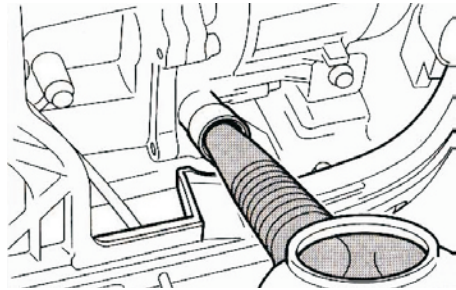

Figure 3

Replace oil filler cap and secure side panel with screws.

**Recommended engine oil:**

- A. YAMALUBE 4 (10W-40)  
SAE10W-30 or 10W-40
- B. SAE #30
- C. SAE#20
- D. SAE#10W

Recommended engine oil grade:

API Service SE type or higher

Engine oil quantity:

0.4L (0.42 US qt , 0.35 Imp qt)

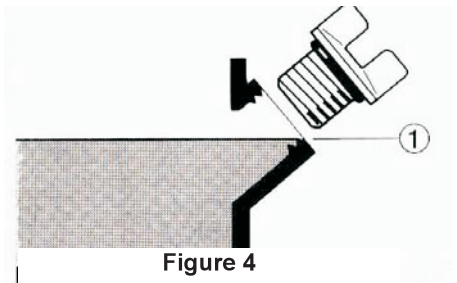

Figure 4

### 3.3 Adding Fuel

The fuel tank capacity 1.1 GAL.

DO NOT overfill the tank, otherwise it may overflow when the fuel warms up and expands.



**Note:**

*For safety reasons, once fuel has been added to this unit it cannot be returned to the place of purchase.*

1. Use clean, fresh, regular unleaded fuel with a minimum octane rating of 85.
2. DO NOT mix oil with fuel.
3. Clean area around the fuel cap.
4. Remove the fuel cap.
5. Be sure that the fuel strainer is in place.
6. Slowly add fuel to the tank.
7. Do not exceed the red marker position of the fuel filter.
8. Screw on the fuel cap and wipe away and spilled fuel.

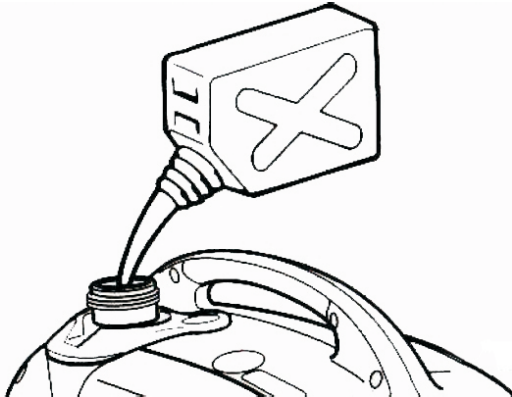

**Note:**

*Use only unleaded gasoline.*

*The use of leaded gasoline will cause severe damage to internal engine parts.*

After filling with fuel, make sure the fuel tank cap is tightened securely.

### 3.4 Starting the Engine

OPERATE THE ENGINE IN A WELL VENTILATED AREA.

**DO NOT** connect any electrical devices to the outlets on the generator before starting the engine.

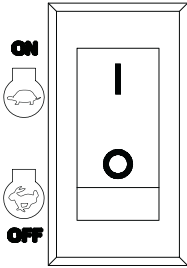

1. Turn the Economy Throttle switch "OFF"  
You may turn the Economy Throttle switch to "ON" once the engine is started and a steady idle is achieved. (below 0°(32°F)/5mins, below 5°C(41°F)/3mins.)

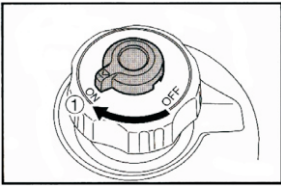

2. While holding the fuel tank cap so that it will not move, turn the air vent knob to "ON".

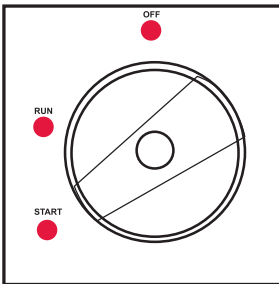

3. Turn the multi-switch to the "START" position.

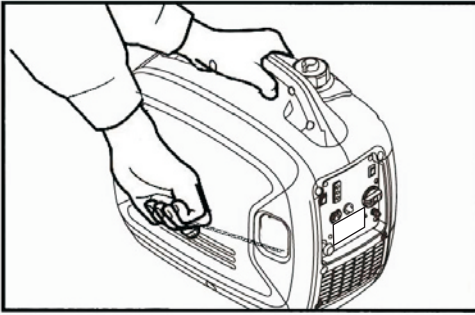

4. Grasp the carrying handle firmly to prevent the generator from falling over when pulling the recoil starter.

5. Pull slowly on the recoil starter until it is engaged and then pull it briskly.

6. After the engine starts, warm up the engine until the engine does not stop when the choke knob is returned the original position.

### 3.5 Stopping the Engine

Before stopping the engine turn off and disconnect any electronic devices attached to the generator.

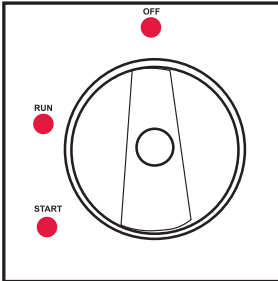

1. Turn the multi-switch to the "OFF" position.

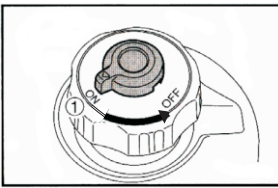

2. While holding the fuel tank cap so that it will not move, turn the air vent knob to "OFF".



# **SECTION 4:**

## **Electrical Connection**

### **4.1 Capacity**

Follow these simple steps to calculate the running and starting watts necessary for your purposes.

*See Section 4.5 for Wattage Reference Guide.*

1. Select the electrical devices you plan on running at the same time.
2. Total the running watts of these items. This is the amount of power you need to keep your items running.
3. Identify the highest starting wattage of all devices identified in step 1
  - a. Add this number to the number calculated in step 2
  - b. Surge wattage is the extra burst of power needed to start some electric driven equipment. Following the steps listed under “Power Management” will guarantee that only one device will be starting at a time.

### **4.2 Power Management**

Use the following formula to convert voltage and amperage to watts:

Volts x Amps = Watts

**To prolong the life of your generator and attached devices, follow these steps to add electrical load:**

1. Start the generator with no electrical load attached.
2. Allow the engine to run for several minutes to stabilize.
3. Plug in and turn on the first item. It is best to attach the item with the largest load first.
4. Allow the engine to stabilize.
5. Plug in and turn on the next item.
6. Allow the engine to stabilize.
7. Repeat steps 5-6 for each additional

### **4.3 Connecting Electrical Loads**

1. Let the engine stabilize and warm up a few minutes after starting.

2. Prior to powering tools and equipment, make sure the generator's rated voltage, and amperage capacity ( 120V AC @ 7 AMPs, 12V DC @ 8 AMPs) is adequate to supply all electrical loads that the unit will power. If powering exceeds the generator's capacity, it may be necessary to group one or more of the tools and/or equipment for connection to a separate generator.
3. Once the generator is running, simply connect the power cords of 120 volt AC powered tools and equipment into the 120 volt AC dual outlets and/or the power cord of a 12V DC powered tool to the DC terminals..
4. DO NOT connect 3-phase loads to the generator.
5. DO NOT connect 50Hz loads to the generator.
6. DO NOT overload the generator.



**Note:** The DC terminals may be used for charging 12 volt automotive type batteries only.

## 4.4 Parallel Connection within 2 Generators

Performance : Allows you to increase the output by connecting two generators together. By using the parallel connection wires provided.

### 1.2 SUA2000i inverter generators needed

Attention: Be sure generators are powered off and without load when connecting the parallel wires.

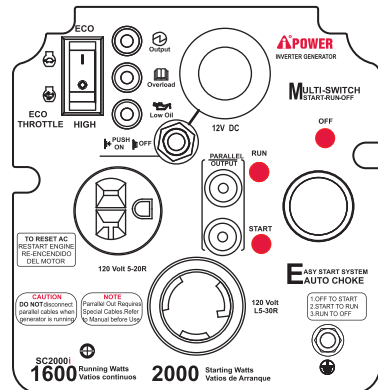

2. put the parallel connection wire 1 and 2 into the parallel connection sockets 3 and 4.

**Attention:** Grounding Wire must be properly connected.

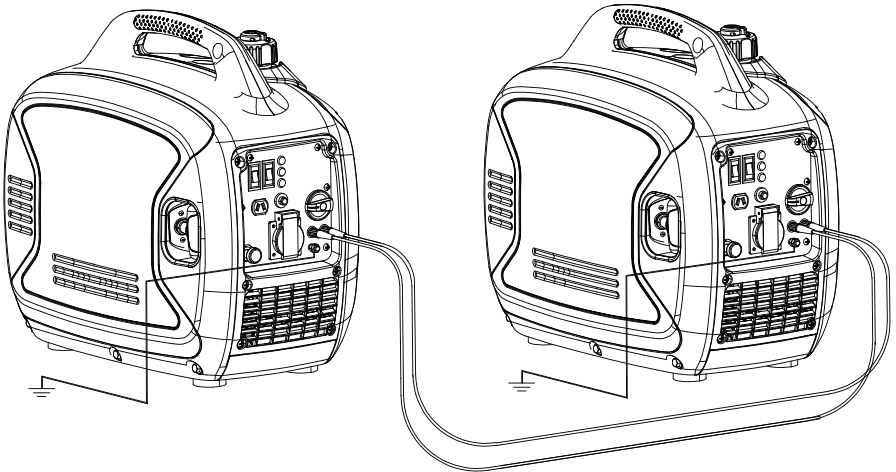
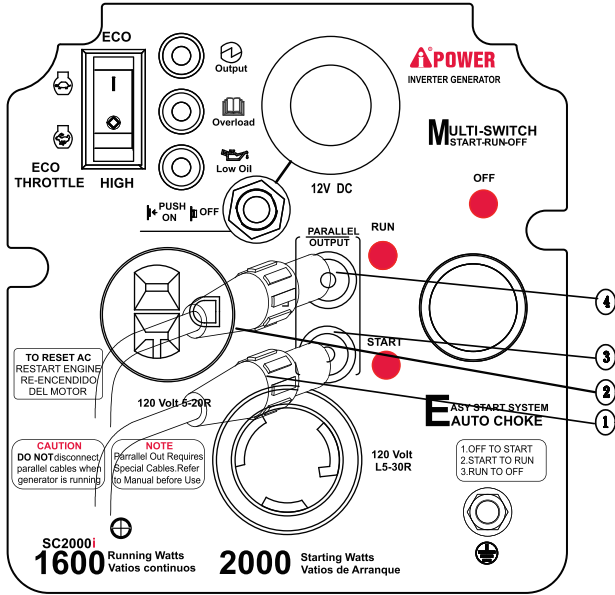

3. Start 2 sets of inverter generators. The starting operation is as the same as normal process( refer on manual book starting parts)

**Attention:** Please make sure the parallel connection wires have been put into the parallel connection sockets properly. If not connected properly, starting inverter generator could be damaged.

4. The load plugs can now be plugged into socket 6.

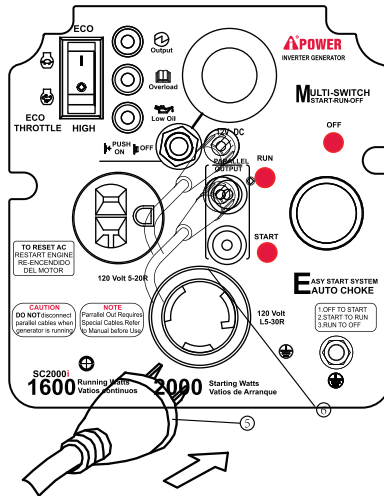

## Warning:

Only 2 sets of SUA2000i inverter generator can be parallel connected.

Only use SUA2000i parallel connecting wire.

Make sure to connect the correct parallel wire into the correct socket.

Connect the parallel wires when generator is off.

Parallel wires are not necessary when only one generator is being used.

Read SUA2000i manual book carefully before operation.

## 4.5 Battery Charging

Start the engine first and allow it to reach idle before connecting the generator to the battery. Battery Charging is performed using the 12V DC outlet only.

1. Be sure the Throttle switch is turned “**OFF**” while charging batteries.
2. Be sure to connect the red battery charger lead to the positive (+) battery terminal, and connect the black lead to the negative (-) battery terminal. DO NOT reverse these positions.
3. Connect the battery charger leads to the battery terminals securely so that they do not disconnect due do engine vibration or other disturbances.
4. Charge the battery by following the instructions in the owner’s manual for the battery.
5. The DC Circuit Breaker will turn “**OFF**” automatically if the current exceeds rated output.
6. To restart charging the battery, turn the DC protector on by pressing its button to “**ON**”
7. Refer to the owner’s manual for the battery to determine charging times.



**Note:** *Never start or stop the generator with electrical devices plugged in or turned on.*

## 4.6 Wattage Reference Guide

Item	Running Watts	Starting Watts
<b>Essentials</b>		
Light Bulb	100	100
Refrigerator/Freezer	1200	2400
Sump Pump	600	1800
Well Pump 1HP	2000	4000
Water Heater	4000	
Security System	180	
AM/FM Radio	300	
Garage Door Opener ½ HP	500	600
Battery Charger 12V	110	
<b>Heating and Cooling</b>		
Air Conditioner 12000 BTU	1700	2500
Fan	300	600
Furnace Fan 1/3 HP	1200	2000
<b>Home Appliances</b>		
Microwave	1000	
Electric Range – One Element	1500	
Electric Skillet	1250	
Coffee Maker	1500	
Clothes Washer	1200	
<b>Entertainment</b>		
CD/DVD Player	100	
Stereo Receiver	450	
Television 27"	500	
PC with 15" Monitor	800	
<b>Job Site</b>		
Belt Sander 3"	1000	1500
Bench Grinder 6"	700	1500
Circular Saw	1500	1500
Compressor 1 ½ HP	1000	1000
Edge Trimmer	500	500
Hand Drill ½"	1000	1000
Paint Sprayer	600	1200
Table Saw	2000	2000

These are estimates only. Check your tool or appliance for exact wattage requirements. The wattages listed are based on estimated wattage requirements.

For exact wattages, check the data plate or owner's manual on the item you wish to power using the generator.

Operating voltage and frequency requirement of all electronic equipment should be checked prior to plugging to plugging them into this generator. Damage may result if the equipment is not designed to operate within a +/- 10% voltage variation, and +/- 3 Hz frequency variation from the generator specification ratings.

## Your Power Needs

<b>Tool or Appliance</b>	<b>Running Watts</b>	<b>Starting Watts</b>
1.		
2.		
3.		
4.		
5.		
Total Running Watts		
	Highest Starting Watts	

<b>Total Running Watts + Highest Starting Watts</b>	
---	--

# SECTION 5:

## Maintenance

### 5.1 Periodic Maintenance

Periodic inspection, adjustment and lubrication will keep your generator in the safest and most efficient condition possible.

Item	Routine	Prior to use	Every	
			6mos. or 100hrs.	12mos. or 300hrs.
Spark Plug	<ul style="list-style-type: none"> <li>• Check condition</li> <li>• Clean and replace if necessary</li> </ul>		•	
Fuel	<ul style="list-style-type: none"> <li>• Check fuel level and leakage.</li> </ul>	•		
Fuel hose	<ul style="list-style-type: none"> <li>• Check fuel hose for cracks or damage</li> <li>• Replace if necessary.</li> </ul>	•		
Engine oil	<ul style="list-style-type: none"> <li>• Check oil level in engine.</li> </ul>	•		
	<ul style="list-style-type: none"> <li>• Replace*</li> </ul>		•*	
Air Filter Element	<ul style="list-style-type: none"> <li>• Check condition</li> <li>• Clean</li> </ul>		•	
Muffler Screen	<ul style="list-style-type: none"> <li>• Check Condition</li> <li>• Clean or replace if necessary</li> </ul>		•	
Spark Arrestor	<ul style="list-style-type: none"> <li>• Check Condition</li> <li>• Clean or replace if necessary</li> </ul>		•	
Fuel Filter	<ul style="list-style-type: none"> <li>• Check Condition</li> <li>• Clean or replace if necessary</li> </ul>			•

\* Initial replacement of the engine oil is after one month or 20 hours of operation.



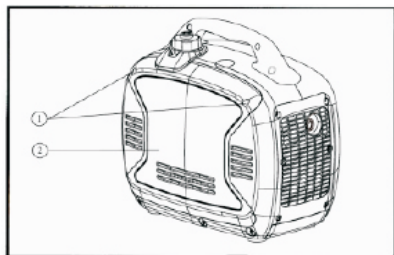

## 5.2 Spark Plug Maintenance

### Spark plug inspection

The spark plug is an important engine component and should be checked periodically.

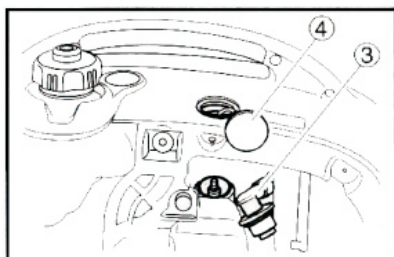

1. Remove the screws ① and then remove the cover ②.

2. Remove the spark plug cap ③ and access cap ④

3. Insert the tool ⑤ through the hole in the outside of the cover.

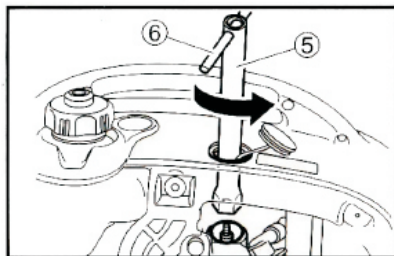

4. Insert the handlebar ⑥ into the tool ⑤ and turn it counterclockwise to remove the spark plug.

5. Check for discoloration. The carbon porcelain insulator around the center electrode of spark plug should be a Medium-to-light tan color.

6. Check the spark plug type and gap. The spark plug gap should be measured with a wire thickness gauge and, if necessary, adjusted to specification.

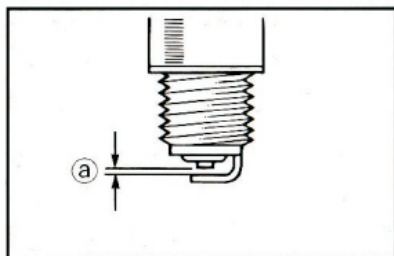

#### Spark Plug Type:

TORCH E5T(E5RTC)

#### Spark Plug Gap:

0.6-0.7 mm (0.024-0.028 in)

#### Spark Plug Torque:

20.0 N·m (2.0kgf·m, 14.8 lbf·ft)

7. Install spark plug, spark plug cap, cover and screws.

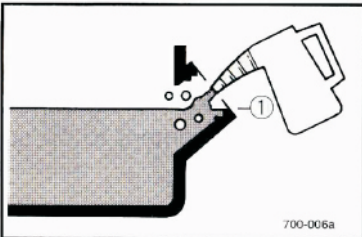
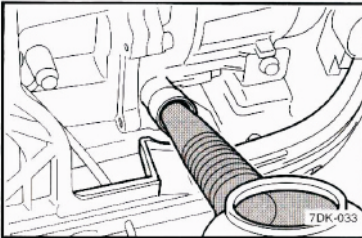
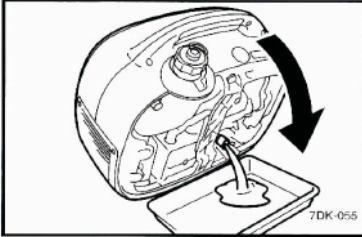
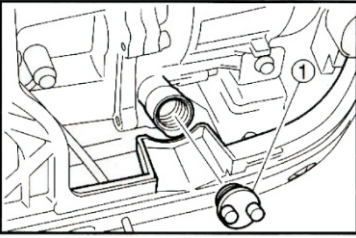
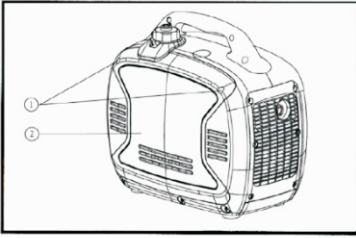

## 5.3 Engine Oil Replacement

Initial replacement of the engine oil is after one month or 20 hours of operation.

1. Place the generator on a level surface and warm up the engine for several minutes. Then stop the engine and turn the Fuel Petcock knob to "OFF" and the Fuel Tank Cap Air Vent knob to "OFF".
2. Remove the screws ① and then remove the cover ②.
3. Remove the oil filler cap.
4. Place an oil pan under the engine. Tilt the generator to drain the oil completely.
5. Return the generator to a level surface.

**Note:** DO NOT tilt the generator when adding engine oil. This could result in overfilling and damage to the engine.

6. Add engine oil to the upper level as seen in the diagram ①.

### Recommended engine oil:

- YAMALUBE 4 (10W-40), SAE 10W-30 or 10W-40
- SAE#30
- SAE#20
- SAE10W

### Recommended engine oil grade:

API Service SE type or higher

### Engine oil quantity:

0.4L (0.42US qt, 0.035 Imp qt)

7. Install oil filler cap, cover, and screws.

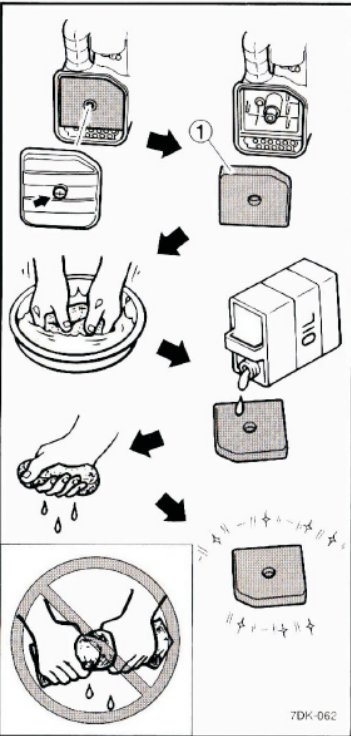
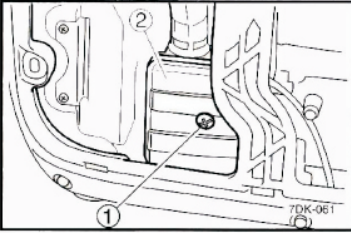
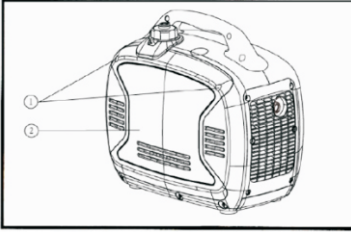

## 5.4 Air Filter Maintenance

Should be performed every 6 months or 100 hours. The air filter may need to be cleaned more frequently when using in unusually wet or dusty areas.

1. Remove the screws ① and then remove the cover ②.
2. Remove the screws ① and then remove the air filter case cover ②.
3. Remove the foam element ①.
4. Wash the foam element in solvent and dry it.
5. Oil the foam element and squeeze out excess oil. The foam element should be wet but not dripping.
6. Insert the foam element into the air filter case. Be sure the foam element sealing surface matches the air filter so there is no air leak.

**NOTE:** Do not wring out the foam element when squeezing it. This could cause it to tear.

**NOTE:** Never operate the engine without foam element.

7. Install air filter case cover, cover, and screws.

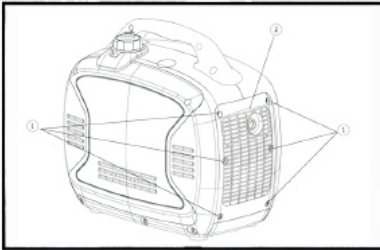

## 5.5 Muffler Screen and Spark Arrestor Maintenance

Should be performed every 6 months or 100 hours. The air filter may need to be cleaned more frequently when using in unusually wet or dusty areas.

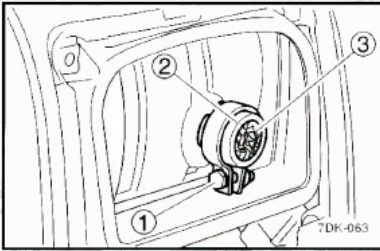

1. Remove the screws ① and then remove the cover ②.
2. Loosen the bolt ① and the remove the muffler cap ②, the muffler screen ③ and spark arrester ④

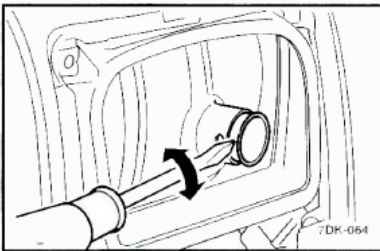

3. Remove the carbon deposits on the muffler screen and spark arrester using a wire brush. Use wire brush lightly to avoid damaging the muffler screen or spark arrester.

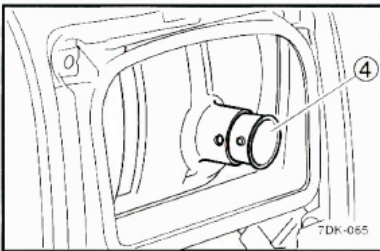

4. Check the muffler screen and spark arrester replace them if damaged.
5. Install the spark arrester.
6. Install the muffler cap.
7. Install the cover and tighten the screws.

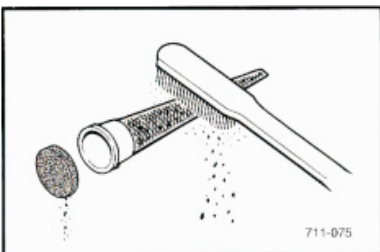

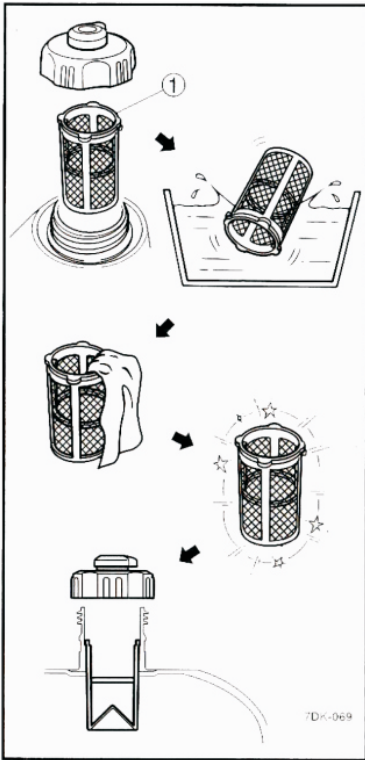

## 5.6 Fuel Filter Maintenance

Should be performed every 12 months or 300 hours.

1. Remove the fuel tank cap and filter ①.
2. Clean the filter with gasoline.
3. If damaged, replace it.
4. Wipe the filter and install it.
5. Install the fuel tank cap.

### **WARNING!**

**GASOLINE IS FLAMMABLE. DO NOT perform this maintenance while smoking or near an open flame.**

## SECTION 6:

### Storage

#### 6.1 Long Term Storage

Long term storage of your generator will require some preventive procedures to guard against deterioration.

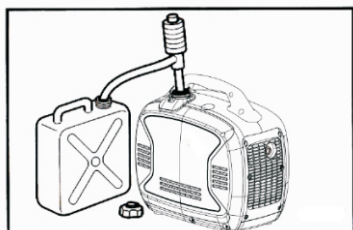

##### 1. Drain the fuel

Remove the fuel tank cap. Extract the fuel tank into an approved gasoline container using a commercially available hand siphon. Then install the fuel tank cap.

### **WARNING!**

**GASOLINE IS FLAMMABLE. DO NOT perform this maintenance while smoking or near an open flame.**

**Immediately wipe off spilled fuel with a clean, dry, soft cloth, since fuel may deteriorate painted surfaces or plastic parts.**

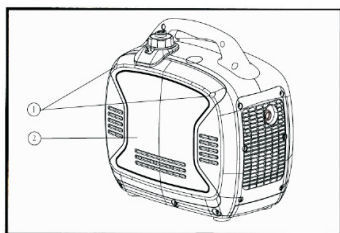

2. Start the engine and let it run until it stops. Duration of the running engine depends on the amount of the fuel left in the tank.

3. Remove the screws ①, and then remove the cover ②.

4. Drain the fuel from the carburetor by loosening the drain screw ③ on the carburetor float chamber. Tighten the drain screw.

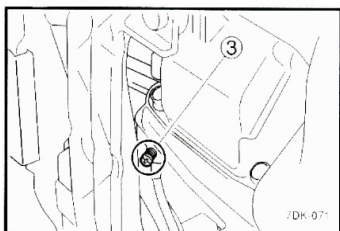

5. Remove the dipstick and drain the engine oil. Then tighten the dipstick.

6. Install the cover and tighten the screws.

7. Turn the fuel tank cap air vent knob to "OFF"

8. Store the generator in a dry, well-ventilated place, with the cover placed over it.

## **Engine**

Perform the following steps to protect the cylinder, piston ring, etc. from corrosion.

1. Remove the spark plug, pour about one table-spoon of SAE 10W-30 or 20W-40 motor oil into the spark plug hole and reinstall the spark plug. Recoil start the engine by turning over several times (with ignition off) to coat the cylinder walls with oil.
2. Pull the recoil starter until you feel compression. Then stop pulling. (this prevents the cylinder and valves from rusting).
3. Clean exterior of the generator and apply a rust inhibitor.
4. Store the generator in a dry, well-ventilated place, with the cover placed over it.
5. The generator must remain in a vertical position when stored, carried, or operated.

# SECTION 7:

## Troubleshooting and Specifications

### 7.1 Troubleshooting Diagram

AE00515

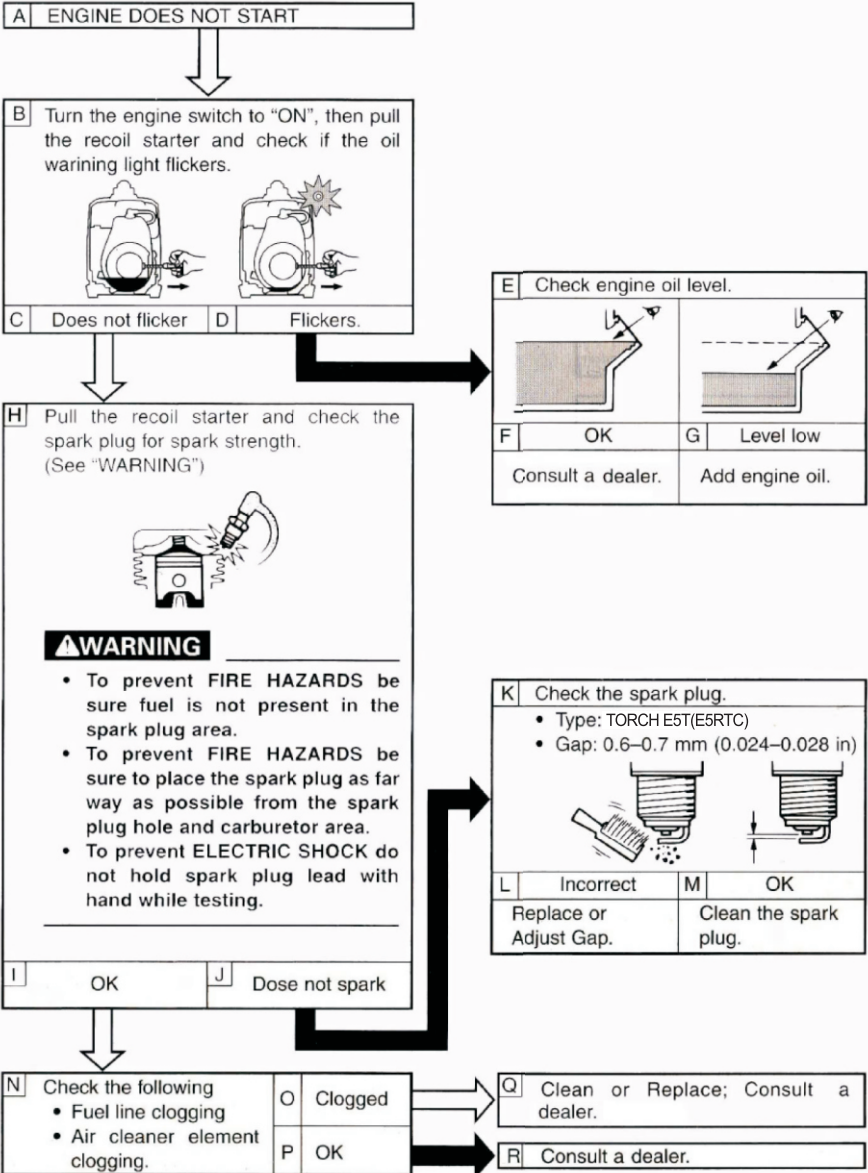

Please call our customer service @ 1-855-888-3598 for help.



## 7.2 Fuel Filter Maintenance

Use this section to troubleshoot common errors.

### Engine won't start

#### **Fuel systems: No fuel supplied to combustion chamber**

- No fuel in tank.....supply fuel.
- Fuel in tank.....Fuel tank cap air vent knob and fuel cock knob to "ON".
- Clogged fuel line.....clean fuel line.
- Clogged carburetor....clean carburetor.

#### **Engine oil system insufficient**

- Oil level is low....add engine oil.

#### **Electrical systems**

- Engine switch to "ON" and pull the recoil starter. Poor spark
- Spark plug dirty with carbon or wet...Remove carbon or wipe spark plug dry.
- Faulty ignition system....Consult a service center.

#### **Generator won't produce power**

- Safety device (DC protector) to "OFF" ....press the DC protector to "ON"
- Safety device (AC) to "OFF"....stop the engine, then restart.

## 7.3 Specifications

Engine Type	4-Stroke OHV Air Cooled Single Cylinder EPA Certified
Engine Displacement (cc)	79cc
Running Watts	1600w
Starting Watts	2000w
Rated Frequency	60Hz
Rated Voltage	120V
Rated Current	13.3A
Run Time	7hrs at 1/2 load
Receptacles (qty.)	120V AC (2);12V7A DC (1)
Net Weight	22 KG
Noise Level (dB)	51dB @ 1/4 Load
Fuel Type	Unleaded gasoline
Gallon	1.1
Oil Type	SAE 10W-40
Start Type	Recoil
Dimensions L x W x H (in.)	530x315x490mm

# SECTION 8 — WARRANTIES

## WARRANTY

### A-IPower LIMITED WARRANTY-2 YEARS RESIDENTIAL AND 1 YEAR COMMERCIAL

Thank you for choosing A-iPower products. To ensure proper registration of your product warranty, please submit your warranty registration along with proof of purchase within 10 days of the date of purchase, this can be done by

a) Completing the Warranty Registration form at the back of this manual and mailing to:

A-IPower CORP  
1477 E CEADR ST UNIT B  
ONTARIO CALIFORNIA 91761 USA

b) Visit us at [www.a-ipower.com](http://www.a-ipower.com) and click the product registration icon

### WARRANTY TERM

A-iPower will provide warranty for any of its products purchased through any authorized A-iPower dealer in North America to the original purchaser and will be warranted against defects in material or workmanship for a period of two (2) years for Consumer use from date of purchase, subject to exclusions noted herein.

Commercial and Rental applications are warranted for a period of one (1) year from date of purchase.

“Consumer Use” – residential household use by a retail consumer

“Commercial Use” – all other use – commercial, business, industrial, or rental purpose

### HOW TO OBTAIN WARRANTY SERVICE

Please call our Customer Service Dept.

855-888-3598 or e-mail to

[support@a-ipower.com](mailto:support@a-ipower.com) Please have necessary information available – Model Number, Serial Number, Proof of Purchase  
**DO NOT RETURN THE PRODUCT TO THE PLACE OF PURCHASE**

A-iPower Customer Service Dept will assist with all product related questions and will help troubleshoot issues and will send any replacement parts as necessary while product is within the warranty

period at no charge. If the issue cannot be resolved then A-iPower Customer Service Dept at its discretion determine and authorize diagnosis and repair through one of its authorized Service Centers. A-iPower Corp at its discretion may choose to provide replace of part, component, or product. Service or replacement of parts at any unauthorized repair facility without prior authorization will not be covered by this warranty.

### WARRANTY EXCLUSIONS

This warranty does not cover the following  
Regular wear and maintenance – this warranty will not cover repair when normal use has exhausted the lifetime of a part(s) or engine

Installation and Maintenance - this warranty does not cover improper or unauthorized assembly, alteration, modification or any other damage resulting from misuse or neglect.

Normal maintenance parts - this warranty does not cover spark plugs, air filters, adjustments, or other related service due to obstructions and other build ups resulting from improper maintenance

Additional exclusions – this warranty does not cover wearable parts such as filers, spark plugs, o-rings, batteries etc. It does not cover any cosmetic defects such as scratches to paint, decals etc. It does not cover any damage resulting from use of non-original manufacturer’s parts, use of aftermarket parts. It does not cover any failures due to acts of God and other force majeure events beyond the control of the manufacturer.

### WARRANTY LIMITS AND IMPLICATIONS AND CONSEQUENTIAL DAMAGES

A-iPower is not obligated to cover any loss of time, use of product, freight cost, or any other incidental or consequential claim from the use of this product. This warranty is in Lieu of all other warranties, express or implied

This warranty gives you specific legal rights which vary from state to state.



# A-iPOWER WARRANTY CLAIM FORM

www.a-ipower.com  
support@a-ipower.com

## Primary Information

Circle one:      Consumer      Dealer      Service

Did you send in your Warranty Card? If not, proof of purchase is required.    Yes    No

Have you ever had a warranty issue with the same unit before?                      Yes    No

Name: \_\_\_\_\_

Phone: \_\_\_\_\_

Address: \_\_\_\_\_  
\_\_\_\_\_

City, State, Zip code: \_\_\_\_\_

**Date of purchase:** \_\_\_\_\_ **Where:** \_\_\_\_\_

## Internal Use

Serial Number

Model

Color

Claim Number

Registration Number

## Problem Description

---

---

---

---

---

## Action Take

**YOUR POWER SOLUTION!**



---

1477 E. Cedar Street # B,  
Ontario, CA 91761, U.S.A.  
Phone: 626-888-3598  
support@a-ipower.com  
www. a-ipower.com