



INNOVATION
It's in the air.



INNOVATION

It's in the air.

**PATENTED SILENT AIR STATIONARY
PISTON TECHNOLOGY UP TO 50HP**

**SMART AIR WI-FI ENABLED
PISTON TECHNOLOGY UP TO 100HP**

**HYDRO WATER COOLED 100% NON-STOP
PISTON TECHNOLOGY UP TO 100HP**

**VARIABLE SPEED 30% ENERGY SAVINGS
ROTARY SCREW TECHNOLOGY UP TO 400HP**

**SINGLE PHASE PISTON COMPRESSOR
TECHNOLOGY UP TO 100HP**



CONTENT'S

AIR TECHNOLOGIES

SECTION **01** **PISTON TECH**
PAGES 006-023

SECTION **02** **ROTARY SCREW**
PAGES 024-031

SECTION **03** **AIR DRYERS**
PAGES 028-029

SECTION **04** **GAS & DIESEL**
PAGES 032-039

SECTION **05** **PNEUMATIC TOOLS**
PAGES 040-043

SECTION **06** **SPRAY GUNS**
PAGES 044-049

SECTION **07** **STANDARD DUTY**
PAGES 050-051

ADDITIONAL

- SMART AIR..... 004
- SILENT AIR..... 005
- LUBRICATION SYSTEMS..... 022-023
- WARRANTY..... 052-055
- ENERGY SAVINGS..... 012-013
- SMART OIL..... 056-057
- MERCHANT PROGRAM..... 058
- SMART AIR SUPPORT..... 058
- SERVICE AND PARTS..... 059

WORK SMARTER.

UP TO 90% ENERGY SAVINGS

Smart Air is a technology that allows you to program your compressor remotely! This technology provides full control over your compressor and important alerts like an oil change warning. This technology also provides energy reduction up to 90%! Smart Air is single and 3 Phase compatible.



PLC DISPLAY

Easily customize your compressor function and air flow with any Wi-Fi Enabled SMART DEVICE.

SMARTAIR

THE FUTURE OF AIR TECHNOLOGY



U.S. PATENT
NO. 11,466,675



UP TO 50[%]

NOISE REDUCTION

AHH...
SILENCE...

Our Silent Air system dissipates compressor intake noise by channeling the intake air through a series of noise cancellation plates. This low-profile system adds 4 levels of air filtration along with making the compressor quiet, reducing DBA ratings by as much as 50%.

 **SILENTAIR**
TECHNOLOGY



 **SILENTAIR**
TECHNOLOGY



PISTON COMPRESSORS

ELECTRIC, STATIONARIES, AND PORTABLES

3:38 PM - Fri Jul 19 192.168.8.10

Apple Bing Google Yahoo Google

Compressor Settings

Main Oil Daily Adm

Main

Compressor Settings

Address	Name	Value
9011	Daily On-Off	<input checked="" type="radio"/> False <input type="radio"/> True
9002	Set Tank PSI	<input type="text" value="135"/>
9007	Tank PSI	<input type="text" value="65"/>
18385	PSI Above Tank PSI	<input type="text" value="5"/>
9090	Sleep Delay	<input type="text" value="60"/>
9093	Motor Speed	<input type="text" value="0"/>
9015	Oil Pressure	<input type="text" value="0"/>
9078	Runtime Hours	<input type="text" value="0"/>
9028	Low Oil Pressure	<input type="text" value="0"/>
9034	Change_Oil_Warning	<input type="text" value="0"/>
9029	Reset Error	<input checked="" type="radio"/> False <input type="radio"/> True
9028	Unloader Valve	<input type="text" value="0"/>
9096	Running MINS/HR	<input type="text" value="0"/>
9098	Non-Running MINS/HR	<input type="text" value="0"/>
9100	PLTOL_CV100_F	<input type="text" value="0"/>



PROTECT IT!

1 YEAR STANDARD WARRANTY

5 YEAR EXTENDED WARRANTY

or



EXTENDED LIFETIME WARRANTY

Go to pages 052 - 053





HYDRO WATER COOLED PUMP

Our all new **HYDRO** Water Cooled Piston Compressor takes the industry to the next level. Why, you ask? We introduce to you our E850 Piston Compressor with a **100% Duty Cycle**. Go up to **25 HP** with **Single** and **3 Phase**. Our water cooled pump design allows for water to reach every crevasse of the head to absorb the heat. With a combination of antifreeze and water, you can even set this compressor outdoors and feel safe knowing you will not have to worry about pump or head damage.

With our already popular Silent Air Technology (standard with this series) we have taken sound reduction to another level. How? In our new Hydro Water Cooled Pumps, the water also acts as a noise barrier within the pump, and **reduces operating noise an additional 20%!**

This is the quietest Piston Compressor we have ever produced.

The **HYDRO** compressor also comes with an **After Cooler** that uses a **Split Bar Radiator**. The radiator dual function helps to cool the water that is cooling the pump, and assists in cooling the air coming out of the pump. The air produced from the pump is within 5 degrees of the surrounding air temperature. With this radiator combination, **the moisture is also reduced by 50%**, even without a dryer.

The life cycle of a HYDRO unit is 80,000 hours with a regular servicing at every 1000 hours. **HYDRO**, with all of the features of a Rotary Screw compressor with 3 times less the time to service and at a lower cost. Hydro units offers up to 90% start up Energy Savings!

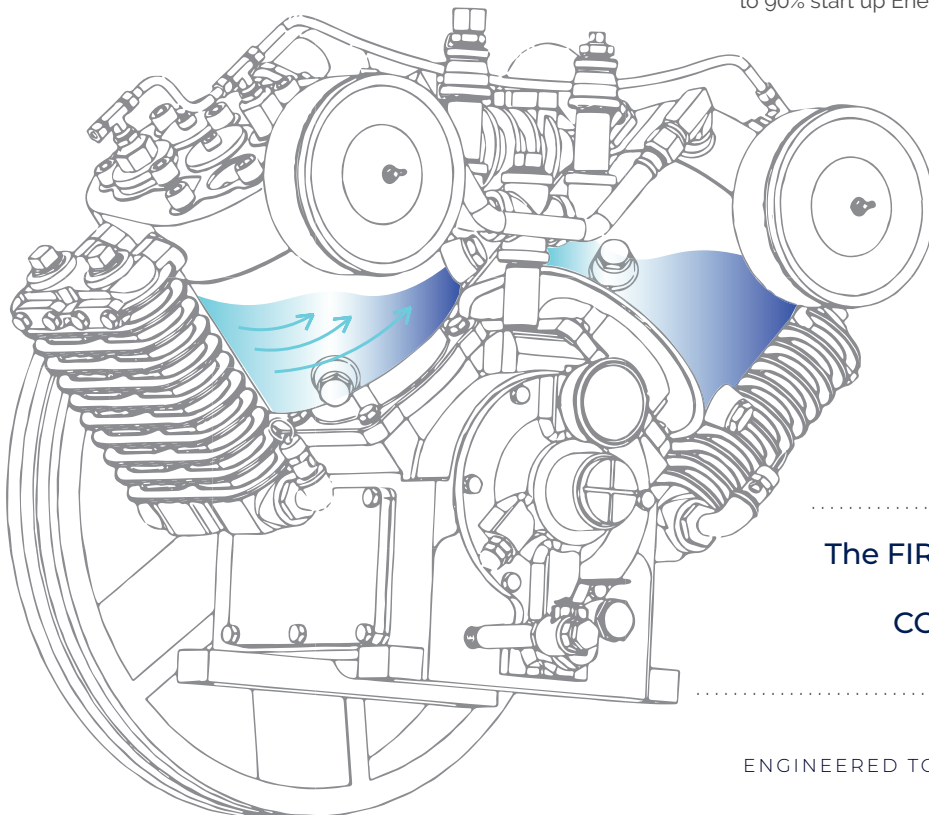

**ENGINEERED TO RUN
24x7x365 NON STOP**

**The FIRST PISTON COMPRESSOR
ENGINEERED FOR 100%
CONTINUOUS DUTY CYCLE
APPLICATIONS**

ENGINEERED TO RUN

24 | 7 | 365





HYDRO E850

FEATURES / SPECS

FEATURES

- WATER COOLED
- 100% DUTY CYCLE
- VARIABLE SPEED
- PRESSURE LUBE PUMP
- WIFI ENABLED
- SILENT AIR
- SMART PLC CONTROL
- AUTOMATIC TANK DRAIN
- CONTINUOUS RUN
- AIR STREAM TECHNOLOGY
- BELT TENSION ADJUSTER
- AFTERCOOLING SYSTEM
- LOW OIL SHUTDOWN
- LIFETIME PUMP WARRANTY
- SINGLE OR 3 PHASE UP TO 25HP



SMART AIR™
U.S. PATENT
NO. 11,466,675



SILENT AIR TECHNOLOGY

Silent Air™ is our exceptionally quiet noise cancellation device along with our patented 5 stage filtration system which together produces significantly lower db

SMART AIR TECHNOLOGY

Smart Air™ is a technology that allows you to program your compressor remotely! This technology provides full control over your compressor and important alerts like an oil change warning! **It also provides energy reduction up to 90%!**

TECH SPECS

	EWV05V08011 EWV05V08013	EWV07V080V1 EWV07V080V3	EWV10V080V1 EWV10V080V3	EWV07V120V1 EWV07V120V3	EWV10V120V1 EWV10V120V3
RUNNING HP	5	7.5	10	7.5	10
CFM 100PSI	19	31	38	31	38
MAX PSI	175	175	175	175	175
PUMP RPM	800	640	800	640	800
MOTOR RPM	1750	1750	1750	1750	1750
MOTOR PHASE	single/three	single/three	single/three	single/three	single/three
DIMENSIONS	42" x 34" x 75"	38" x 42" x 73"	38" x 42" x 73"	41" x 43" x 79"	41" x 43" x 79"
TANK SIZE	80	80	80	120	120
WEIGHT	620	743	810	990	1020



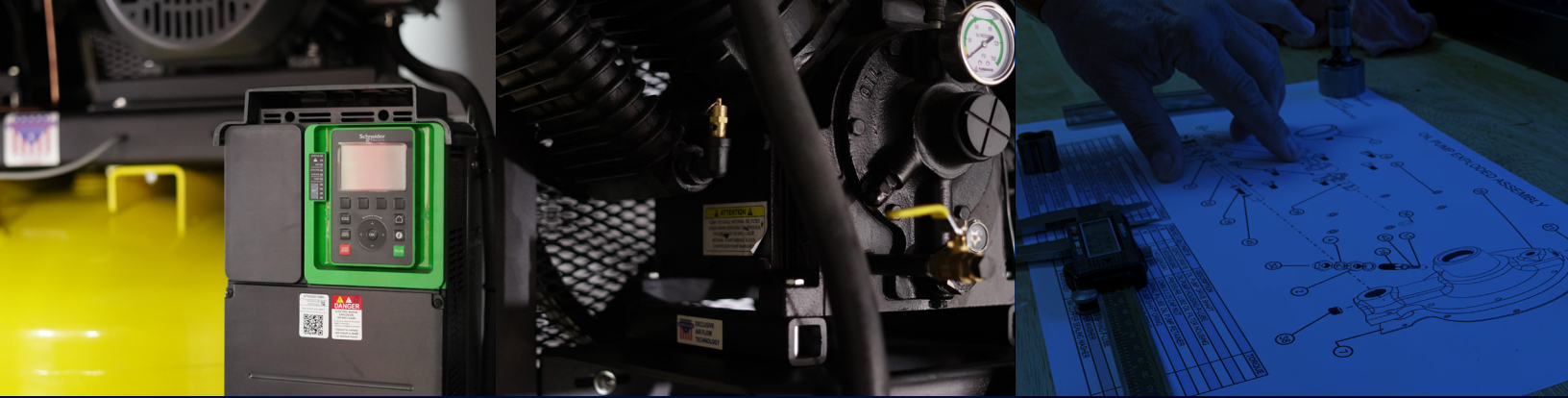

GOLIATH

GOLIATH 180 GALLON

BIGGEST SINGLE PHASE ON THE PLANET.

When you see this machine, you understand why we call this GOLIATH. It has the largest pump, motor, and tank we offer.

Goliath offers up to 90% start up Energy Savings!

This is a **HYDRO** Water Cooled Piston Compressor that is taking the industry to the next level. Why, you ask? It's **100% Duty Cycle** and goes up to **25 HP** with **Single** and **3 Phase**. (EWV25V180V13 Model Only)

Goliath comes with our patented Silent Air system. As a Hydro Water Cooled Pump, the water also acts as a noise barrier within the pump, and **reduces the sound even more by 20%**.

This is the quietest Piston Compressor we have ever produced.

The **Goliath piston** compressor also comes with an **After Cooler** that uses a **Split Bar Radiator**. (EWV25V180V13 Model Only)

The radiator dual function helps to cool the water that is cooling the pump, and assists in cooling the air coming out of the pump. The air produced from the pump is within 5 degrees of the air we breathe. With this radiator combination, **the moisture is also reduced by 50%**, even without a dryer.

The life cycle of this unit is 80,000 hours with a regular servicing at every 1000 hours. It has all of the features of a Rotary Screw compressor with 3 times less the time to service and at a lower cost.

Available in Q4 2023



PROTECT IT!



E850
FEATURES / SPECS

FEATURES

- WATER COOLED
- 100% DUTY CYCLE
- VARIABLE SPEED
- PRESSURE LUBE PUMP
- WIFI ENABLED
- SILENT AIR
- SMART PLC CONTROL
- AUTOMATIC TANK DRAIN
- CONTINUOUS RUN
- AIR STREAM TECHNOLOGY
- BELT TENSION ADJUSTER
- AFTERCOOLING SYSTEM
- LOW OIL SHUTDOWN
- LIFETIME PUMP WARRANTY
- SINGLE OR 3 PHASE UP TO 25HP



SMART AIR™
U.S. PATENT
NO. 11,466,675



SMART AIR TECHNOLOGY

Smart Air™ is a technology that allows you to program your compressor remotely! This technology provides full control over your compressor and important alerts like an oil change warning! **It also provides energy reduction up to 90%!**

EXTENDED LIFETIME WARRANTY

SILENTAIR

TECH SPECS

EWV25V180V13

RUNNING HP	25
CFM	98
MAX PSI	100
PUMP RPM	300-800
MOTOR RPM	1750
MOTOR PHASE	single/three

GOLIATH

www.EmaxCompressor.com



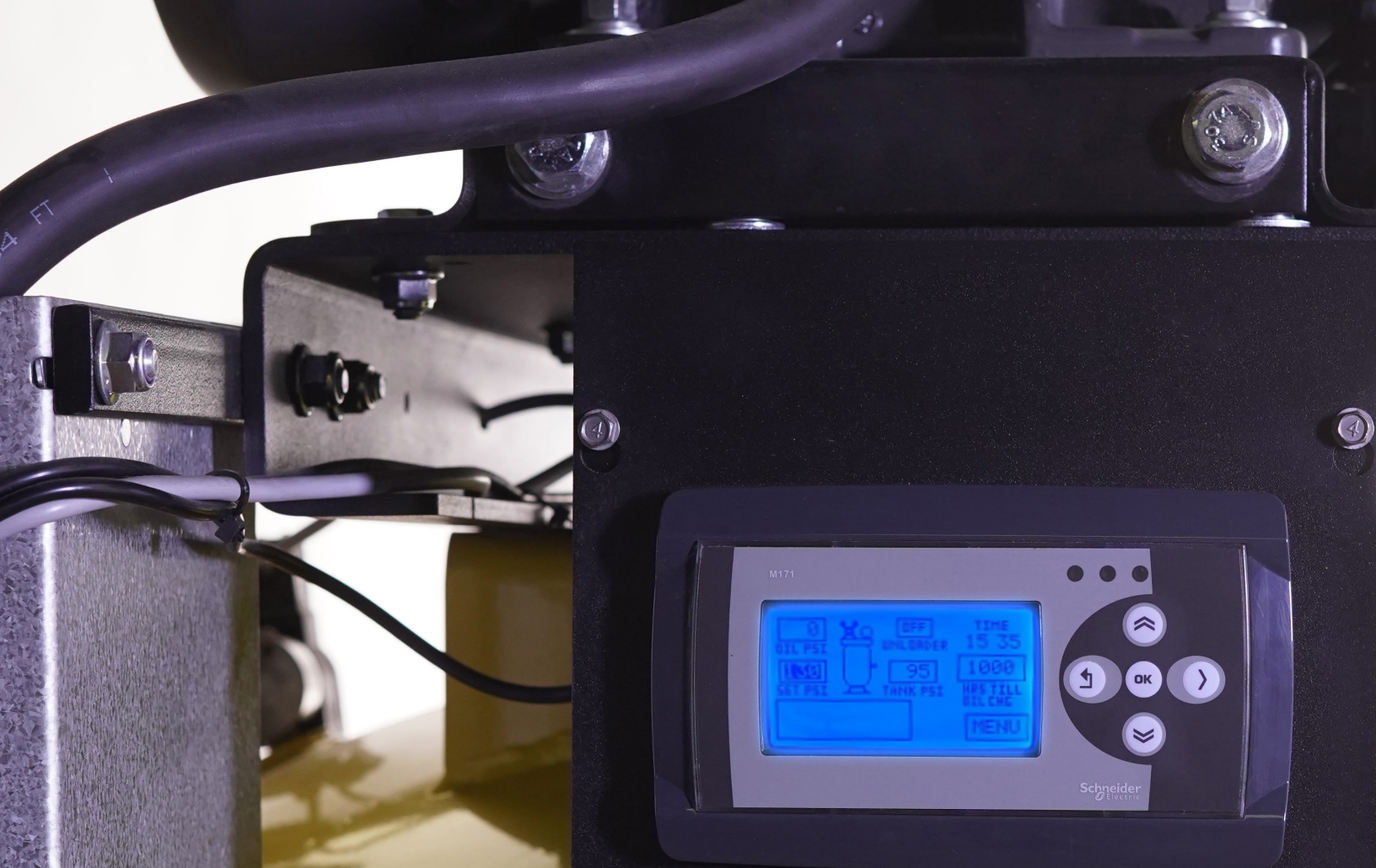

EMAX INDUSTRIAL AIR COMPRESSORS VS. COMPETITORS OPERATING SPECS

AVERAGE COST PER kWh BY STATE ALL SECTORS - COMMERCIAL, INDUSTRIAL, TRANSPORTATION, RESIDENTIAL

THE INDUSTRY'S FIRST A.I. PROGRAMMABLE SMART AIR COMPRESSOR!



SMART AIR™
U.S. PATENT
NO. 11,466,675

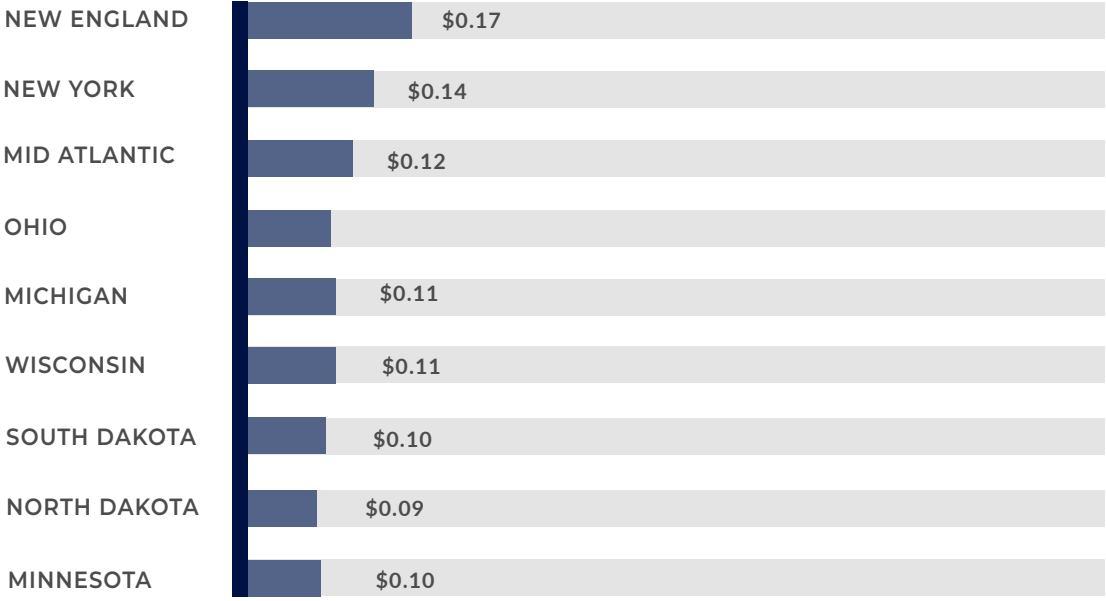

SMART AIR

THE FUTURE OF AIR TECHNOLOGY

Our Programmable Logic Controller Puts You In Control, the PLC guides you through several programmable options like setting the date & hours of operation, PSI and RPM ranges plus many more! Built-in air demand sensor automatically increases or decreases the pump speed and air output, based on actual air demand, thereby reducing energy waste and increasing pump and motor life. Variable speed soft start saves up to 7 times starting energy. Motor gradually increases RPM, keeping startup AMPs at a bare minimum.

Some of the features include automatic shutdown, maintenance warnings, and oil levels. The variable drive allows the unit to be programmed to operate on three phase and single-phase electric. This smart silent air compressor is designed for up to 70,000 hours of commercial or industrial use with proper maintenance. Patented pressure lubricated reciprocating pump. This unit features our patented Whisper100 silent air system already installed. This unit also features our aftercooler system that cools the air going into the tank down to 10 degrees above ambient!

AVERAGE ANNUAL ELECTRIC OPERATING EXPENSE & POTENTIAL SAVINGS 10HP STANDARD 1PH RECIP COMPRESSOR VS EMAX 10HP "SMART AIR" VFD TECHNOLOGY

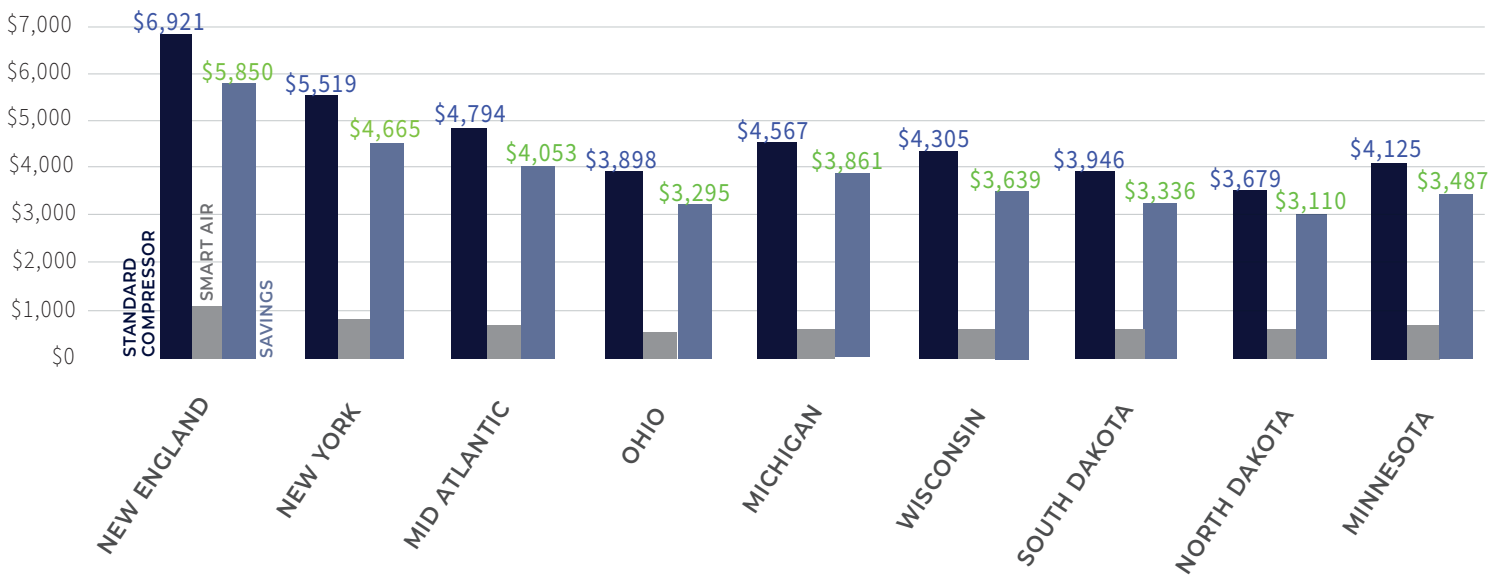

- STANDARD 10HP 1PH RECIPROCATING COMPRESSOR
- EMAX 10HP 1PH VFD RECIPROCATING COMPRESSOR
- POTENTIAL ANNUAL SAVINGS \$



A L L W E A T H E R C O M P R E S S O R

COMING FALL 2023

N E M A 4



The industry's first
ALL WEATHER compressor
with SILENT AIR Technology.

FEATURES

- PATENTED PRESSURE LUBRICATED PUMP**
 Rated 70,000HR Life expectancy
- PATENTED SILENT AIR SYSTEM**
 Lowering the decibels by more than 50% - Providing 4 layers of air filtration
- CONTINUOUS MODE FUNCTIONALITY**
 For workloads over 50% duty cycle eliminates wear and tear on your magnetic contactor
- BELT TENSION ADJUSTOR**
 Easy one-turn design reduces vibration and extends belt life
- AIR STREAM TECHNOLOGY**
 Allows air to flow under the pump
- AUTO TANK DRAIN**
 110-volt dual timer controlled, eliminates daily maintenance



SILENT AIR TECHNOLOGY

EMAX Compressor continues to set the standard in the air compressor industry. EMAX has designed a revolutionary air system like no other! Engineered and manufactured in the USA our patented Whisper Silent Air System dissipates compressor intake noise by channeling the intake air through a series of baffle plates. This low-profile system adds 4 levels of air filtration along with making the compressor quiet, reducing DBA ratings by as much as 50%.



TECH SPECS

	ESP05V08011 ESP05V08013	ESP07V080V1 ESP07V080V3	ESP10V080V1 ESP10V080V3	ESP07V120V1 ESP07V120V3	ESP10V120V1 ESP10V120V3
RUNNING HP	5	7.5	10	7.5	10
CFM 100PSI	19	31	38	31	38
MAX PSI	175	175	175	175	175
PUMP RPM	800	640	800	640	800
MOTOR RPM	1750	1750	1750	1750	1750
MOTOR PHASE	1PH or 3PH	1PH or 3PH	1PH or 3PH	1PH or 3PH	1PH or 3PH
DIMENSIONS	42" x 34" x 75"	38" x 42" x 73"	38" x 42" x 73"	41" x 43" x 79"	41" x 43" x 79"
WEIGHT	620	743	810	990	1020
TANK GALLONS	80	80	80	120	120



E450

FEATURES / SPECS

- **POWDER COATED ASME CERTIFIED TANKS**
200 PSI rating
- **EXCLUSIVE SINGLE PHASE UP TO 10HP**
This industry exclusive delivers up to 38CFM from single phase 10hp models!
- **MAGNETIC STARTER**
This feature is on all 7.5hp and up models. The magnetic starter provides a safe start method along with the overload protection when starting.
- **QUALITY COMPONENTS**
We use B-style belts to ensure smooth operation. Top quality pressure switches, 100% brass valves, ASME Certified tank, 13G steel with premium grade expanded metal belt guards
- **ETL CERTIFIED**
Tested to all safety standards and certified.
- **AUTO TANK DRAIN**
110-volt dual timer controlled, eliminates daily maintenance
- **AIR STREAM TECHNOLOGY**
Allows air to flow under the pump



E450

FEATURES / SPECS

- **PATENTED PRESSURE LUBRICATED PUMP**
Rated 70,000 Hr. Life Expectency.
- **CONTINUOUS MODE FUNCTIONALITY**
For workloads over 50% duty cycle. Eliminates wear and tear on your magnetic contactor
- **BELT TENSION ADJUSTOR**
Easy one-turn design reduces vibration and extends belt life.
- **AUTO TANK DRAIN**
110-volt dual timer controlled, eliminates daily maintenance
- **AIR STREAM TECHNOLOGY**
Allows air to flow under the pump
- **PREMIUM INDUSTRIAL MOTORS**
Low 1750 RPM's



	EP20H120V3	EP25H120V3
RUNNING HP	20	25
CFM 100PSI	82	89
MAX PSI	175	175
PUMP RPM	640	740
MOTOR RPM	1750	1750
MOTOR PHASE OPTIONS	three	three
PRODUCT DIMS	30 x 74 x 61	30 x 74 x 61
PRODUCT WEIGHT	1636	1636
TANK GALLONS	120	120
TANK ORIENTATION	horizontal	horizontal

TECH SPECS

	ESP05V08011-ESP05V080I3	ESP07V080V1-ESP07V080V3	ESP10V080V1-ESP10V080V3	ESP07V120V1-ESP07V120V3	ESP10V120V1-ESP10V120V1
RUNNING HP	5	7.5	10	7.5	10
CFM 100PSI	19	31	38	31	38
MAX PSI	175	175	175	175	175
PUMP RPM	800	640	800	640	800
MOTOR RPM	1750	1750	1750	1750	1750
MOTOR PHASE OPTIONS	1PH or 3PH	1PH or 3PH	1PH or 3PH	1PH or 3PH	1PH or 3PH
PRODUCT DIMS	42 x 34 x 75	38 x 42 x 73	38 x 42 x 73	41 x 43 x 79	41 x 43 x 79
PRODUCT WEIGHT	620	743	810	990	1020
TANK GALLONS	80	80	80	120	120
TANK ORIENTATION	vertical	vertical	vertical	vertical	vertical

	EP15V120Y3
RUNNING HP	15
CFM @100PSI	57
MAX PSI	175
PUMP RPM	640
MOTOR RPM	1750
MOTOR PHASE OPTIONS	1PH or 3PH
PRODUCT DIMS	32 x 45 x 81
PRODUCT WEIGHT	1316
TANK GALLONS	120
TANK ORIENTATION	vertical

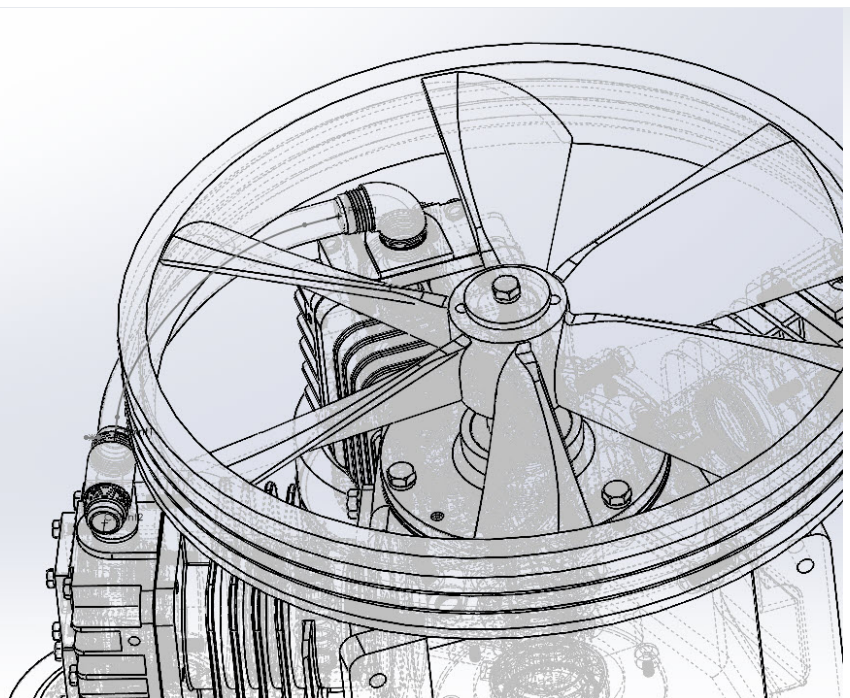

FEATURES

- **PATENTED PRESSURE LUBRICATED PUMP**
Rated 70,000 Hr. Life Expectency.
- **PREMIUM INDUSTRIAL MOTORS**
Low 1750 RPM's.
- **POWDER COATED ASME CERTIFIED TANKS**
200 PSI rating
- **MANUAL BALL VALVE TANK DRAIN**
Easy access to drain tank moisture.
- **QUALITY COMPONENTS**
We use B-style belts to ensure smooth operation. Top quality pressure switches, 100% brass valves, ASME certified tank, powder coated 13G Steel with premium grade expanded metal belt guards.
- **ETL CERTIFIED**
Tested to all safety standards and certified.
- **EXTENDED WARRANTY PLANS**



TECH SPECS

	EI05V08011	EI07V080V1	EI10V080V1
RUNNING HP	5	7.5	10
CFM 100PSI	19	31	38
MAX PSI	175	175	175
PUMP RPM	800	640	800
MOTOR RPM	1750	1750	1750
MOTOR PHASE OPTIONS	single	single	single
PRODUCT DIMS	31 x 33 x 75	27 x 42 x 72	27 x 42 x 72
PRODUCT WEIGHT	576	735	795
TANK GALLONS	80	80	80
TANK ORIENTATION	vertical	vertical	vertical



E350
FEATURES / SPECS

EXTENDED LIFETIME WARRANTY
 SILENTAIR

FEATURES

- **PATENTED PRESSURE LUBRICATED PUMP**
Rated 70,000HR Life Expectency.
- **PATENTED SILENT AIR SYSTEM**
Lowering the decibels by more than 50% - Providing 4 layers of air filtration.
- **PREMIUM INDUSTRIAL MOTORS**
Low 1750 RPM's.
- **POWDER COATED ASME CERTIFIED TANKS**
200 PSI rating
- **MANUAL BALL VALVE TANK DRAIN**
Easy access to drain tank moisture.
- **QUALITY COMPONENTS**
We use B-style belts to ensure smooth operation. Top quality pressure switches, 100% brass valves, ASME certified tank, powder coated 13G Steel with premium grade expanded metal belt guards.
- **ETL CERTIFIED**
Tested to all safety standards.



WITH SILENT AIR TECHNOLOGY

EMAX Compressor 350 series provides all the quality without all the added cost the features can add. EMAX has designed a revolutionary air system like no other! Engineered and manufactured in the USA our patented Silent Air System dissipates compressor intake noise by channeling the intake air through a series of baffle plates. This low-profile system adds 4 levels of air filtration along with making the compressor quiet, reducing DBA ratings by as much as 50%. Now that's being seen but not heard! Our Industrial Plus series come with standard features and only the best quality components. All backed by the best warranty in the industry.

TECH SPECS

	ES05V0801I	ES07V080V1	ES10V080V1
RUNNING HP	5	7.5	10
CFM 100PSI	19	31	38
MAX PSI	175	175	175
PUMP RPM	800	640	800
MOTOR RPM	1750	1750	1750
MOTOR PHASE	Single	single	single
DIMENSIONS	42" x 34" x 75"	38" x 42" x 73"	38" x 42" x 73"
WEIGHT	625	768	834
TANK GALLONS	80	80	80



ALTERNATING COMPRESSORS

ABOUT OUR SMART ALTERNATING COMPRESSORS

Our alternating compressors are set up as a lead compressor and a lag compressor. The lead pump runs until the demand on the system is too great for the pump to meet, at which point the lag pump initiates until demand is met. The second compressor is set up to kick on when the primary compressors pressure becomes too low for the load. Each unit has its own pressure switch set at their own pressure points. When one of the compressors needs to be serviced you will still have a compressor that can keep working for you.

Alternating the lead and lag pumps can greatly increase the life of a system. Because more than one pump is doing the work, pumps will wear evenly. They have our pressure lubricated pumps for quiet operation and our offered extended lifetime pump warranty. TEFC Industrial grade motors, continuous run feature, alternating lead lag switch with secondary pressure switch engineered to double air delivery, automatic tank drains, belt tensioner easy one turn maintenance on belts.

IT'S A NEW ERA

We are in an era where manufacturing using huge compressor air systems are quickly disappearing and a higher number of multiple smaller air compressors. We live in a time when going "green", limited budgets, and businesses are trying to find ways to improve energy efficiency and put money back into their budgets by making good investments. EMAX has taken their Smart Air Compressors to another level with our Alternating Smart Air Series!

These alternating combinations run like our Alternating Industrial plus series except they have the intelligence from our sophisticated software. Smart Air uses a variable speed frequency drive providing constant pressures and precisely meeting varying demand, which is crucial in lead-lag applications. Smart Air can provide significant energy savings, especially in higher horsepower applications. The variable speed drive prevents large current inrush when a motor is started, also referred to as soft start.

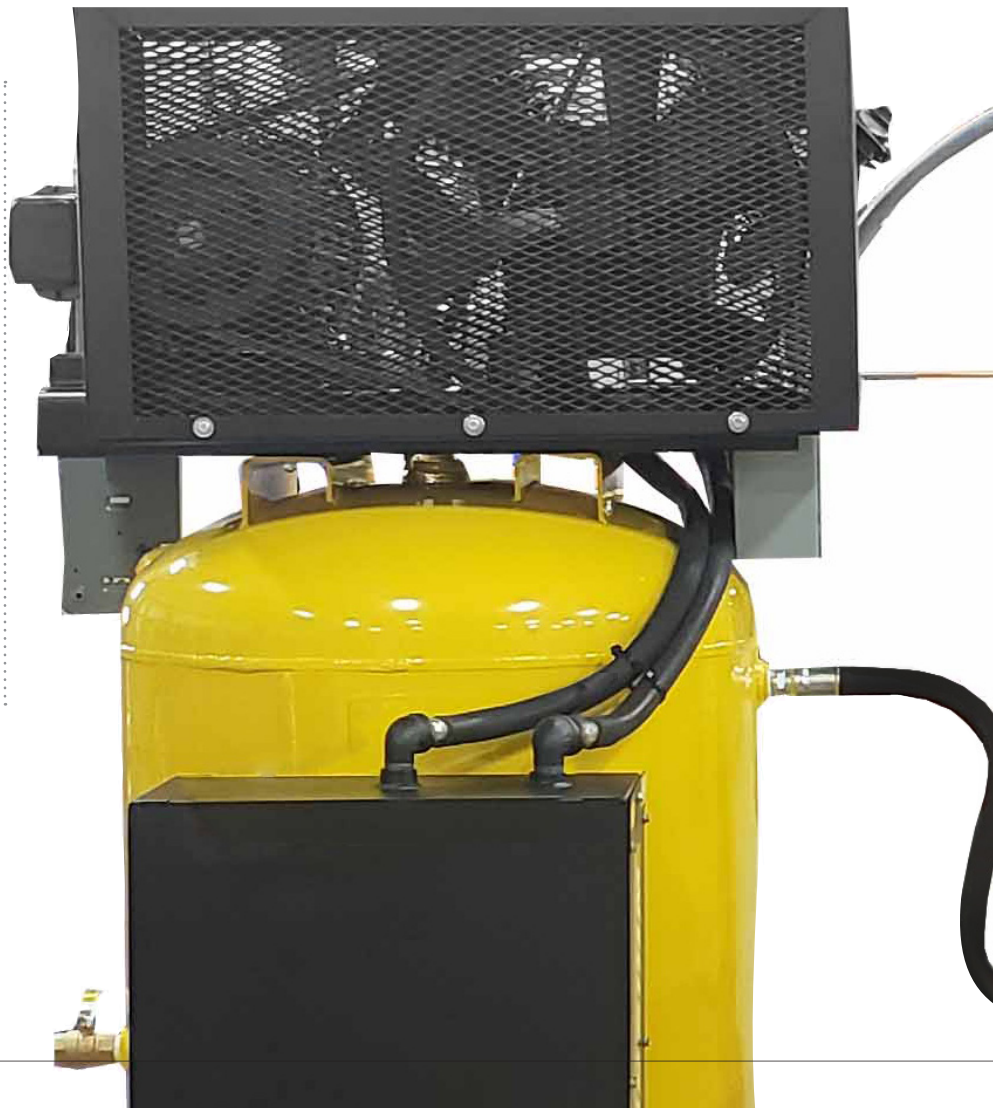

DUAL

Dual pumps supported by one tank alternating airflow.

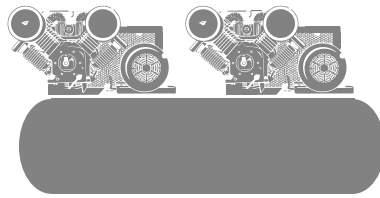

ALTERNATING

Two piston units connected and alternating to maximize efficiency and workflow.

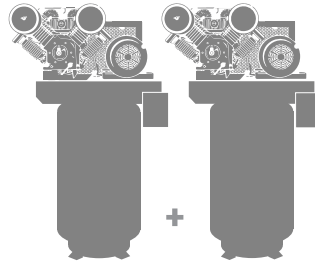

QUADPLEX

Connect up to four alternating smart air piston units via ethernet to maximize efficiency and workflow.

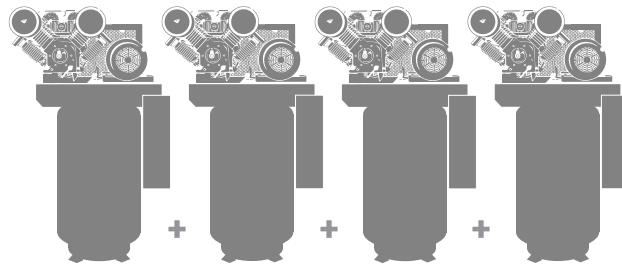

PUMP SPEED ON DEMAND

Each unit has its own programmable controller and variable speed drive, built in demand sensors that automatically increase or decrease pump speed based on demand, saving money and extending pump and motor life.



LUBRICATION EDUCATION

Air compressors require a good lubrication system to operate sufficiently. Knowing your machine and its oil system helps to avoid having to spend unnecessary time on maintenance issues. Oil lubricates, and primarily helps to reduce the friction between the components in the pump of the air compressor. This process will produce less heat from the friction, consume less energy and provide a longer machine lifecycle.

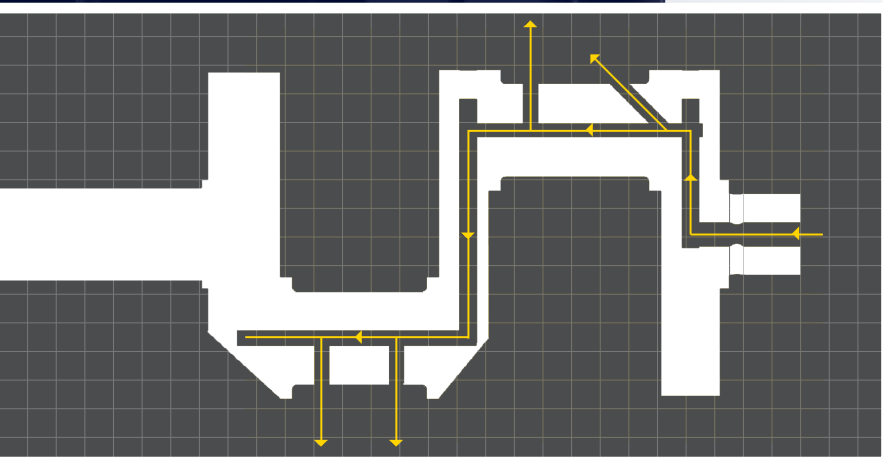

PRESSURE LUBRICATION PATH

THE DIAGRAM ABOVE SHOWS THE CONSTANT OIL FLOW TO CRITICAL AREAS.

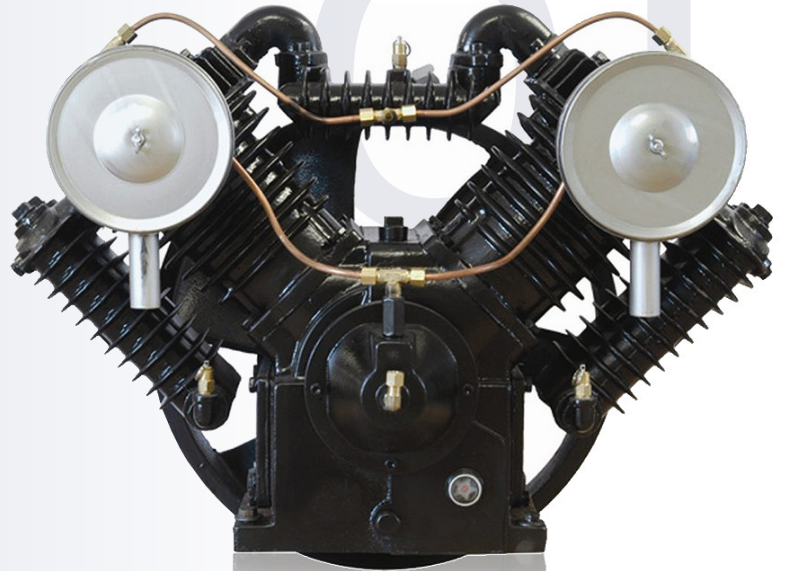

LUBRICATION INNOVATION

When it comes to a reciprocating air compressor pump, the lubrication system is the most critical part of trouble-free operation. The lubrication system provides cooling, reduced friction and sealing. A reciprocating air compressor pump has two lubrication systems, the first being traditional splash lubrication and the other pressure lubrication. So, what's the difference? -

01 SPLASH LUBRICATION

The traditional splash lubrication systems have been around since the first air compressor was produced. Splash lubrication systems work by using dippers that pass through the oil in the crankcase when the pistons are moving and splash the oil up onto the cylinders and pistons to lubricate them. Although this method is effective, its not precise. Parts of the pump may not be receiving enough oil. Where there is not enough oil, wear between critical components can become a costly issue... on the other hand too much oil can also be in issue as well.

Viscosity of the oil becomes important with splash method as well, if the oil is not thick enough it will not cling to the dippers as needed. So, although effective it is becoming an out dated method.

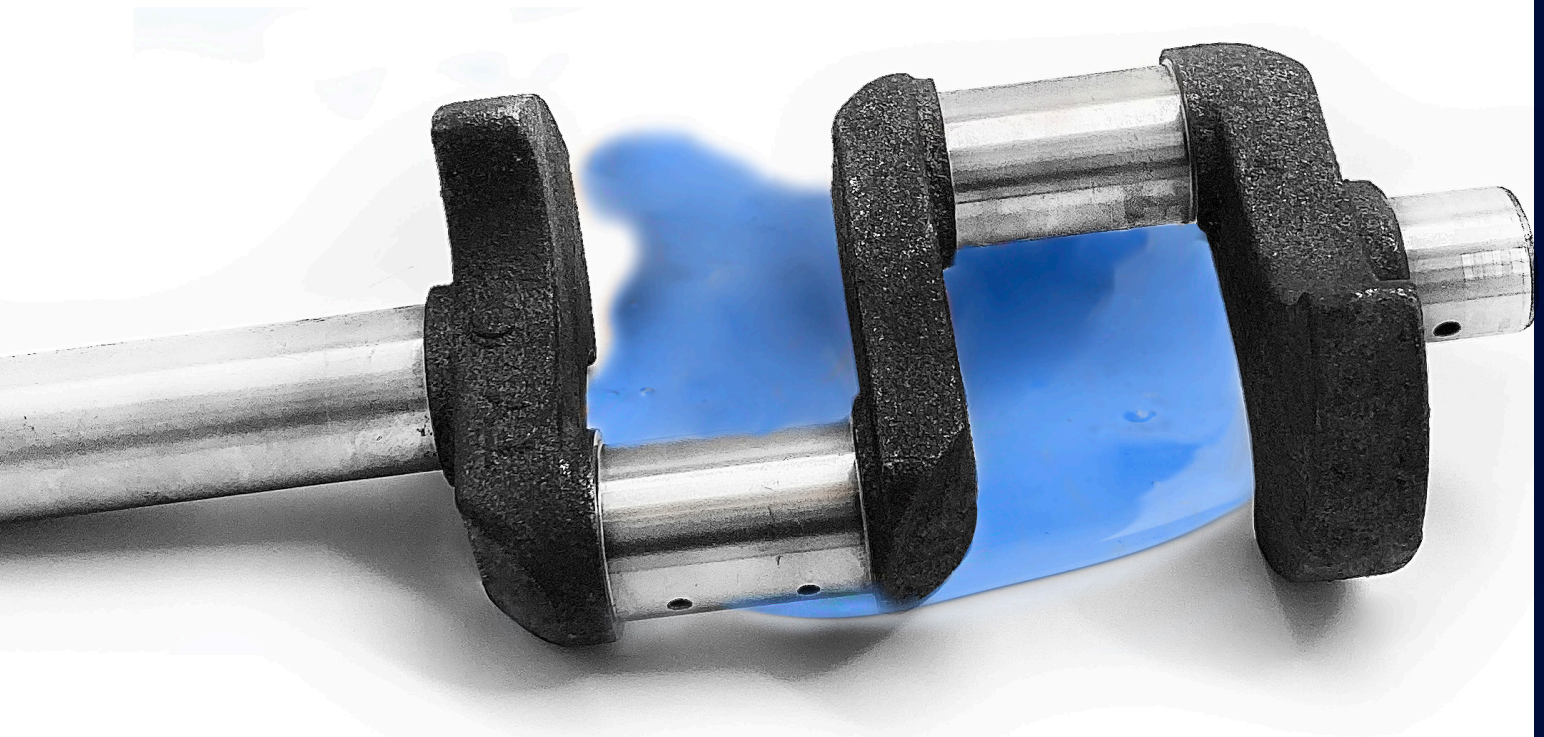

02 PRESSURE LUBRICATION

Pressure Lubrication is the second type of lubrication systems. This system is more technically advanced and a far more precise method to deliver oil to critical parts of the pump, resulting in longer pump life. The oil is pumped through an oil filter and into the pump where it is then recycled and reused. Since the oil pump is delivering the oil more efficiently the viscosity of the oil is less critical than with a splash system. Typically, in the compressor industry it is more costly to upgrade to pressure lubrication systems, because we believe in producing the best compressor over all. Therefore, we build our compressor with our Patented Pressure Lubricated Pumps as a standard feature. These pumps have a 70,000HR + life expectancy, comes with a re-usable oil filter and an oil pressure gauge. We also will back it with our Extended limited Lifetime Pump warranty!





ROTARY SCREW

STATIONARY, TRUCK MOUNT, AND TOWABLES

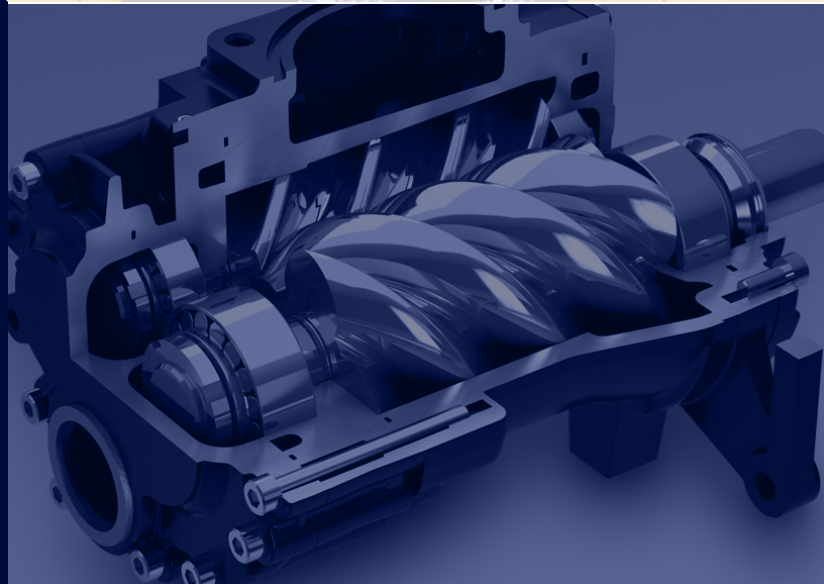



ENGINEERED TO RUN
24 | 7 | 365

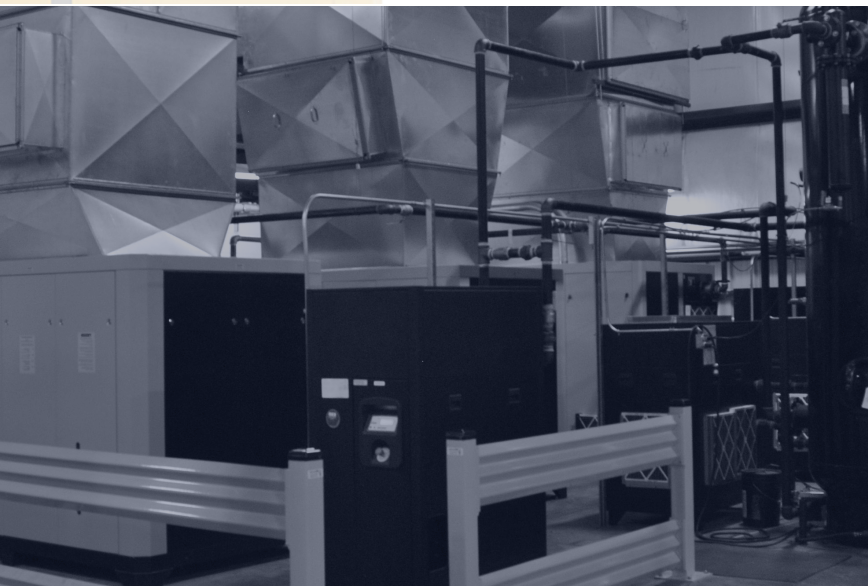

PROTECT IT!

1 YEAR
STANDARD
WARRANTY

or

10 YEAR
EXTENDED
WARRANTY

Go to pages 052 - 053





EMAX

5HP - 400HP

EMAX ROTARY SCREW COMPRESSORS



E2500

60,000HR Italian Air end

Logic 9 controller, 4 function keys, connect through port to PC for monitoring, multi unit operation/communication

5-30HP Fixed Speed Drive Only

Warranty: 1 Year or 5 Year

E3500

100,000HR German Air End

User-Friendly Logika 26 controller, 6 function keys, 9 languages, capability for remote monitoring w/WIFI, multi unit operation/communication

5-400HP Fixed Speed with Variable Speed options

Warranty : Extended LIFETIME plans available

E4500 Variable Speed

100,000HR German Air End

User-Friendly Logika 26 controller, 6 function keys, 9 languages, capability for remote monitoring w/WIFI , multi unit operation/communication

5-400HP High Energy Efficiency Variable Speed Drive yields large savings during start up, on running & peak demands, wear and tear on the compressor saving you huge \$\$

Warranty : Extended LIFETIME plans available

FEATURES

- Precision engineered Italian air end 100% duty cycle with up to 60,000 hours run life cycle.
- Name brand TEFC Premium efficiency electric drive motor..100% duty cycle. .NEMA standard low rpm 4 pole 1750 rpm.
- Y/Delta soft start on all 3 phase models.
Reduces start load by 30%.
- PLC..Logik 9 smart controller.. pressure adjustments, temperature display, compressor status alarms with fault history.
- Master/slave monitoring, with back light, hour meter and auto start if power is lost.
- Quiet..Sound proof enclose , solid steel, powder coated, with easy to remove insulated doors for fast servicing of the compressor.
- Mann filters high efficiency spin on for easy servicing of the compressor. VMC high flow inlet poppet valve for higher compressor air flow and efficiency. Longer life due to lower friction.
- Includes multi tap control transformer 208/230/460/575 volts on all 3 phase models.



TECH SPECS

	ERI0050001	ERI0050003	ERI0070001	ERI0070003	ERI0100001
RUNNING HP	5	5	7	7	10
CFM @ 110PSI	19.42	19.42	24.01	24.01	39.9
MAX PSI	145	145	145	145	145
DRIVE TYPE	BELT	BELT	BELT	BELT	BELT
MOTOR RPM	1750	1750	1750	1750	1750
START TYPE	DOL	WYE/DELTA	DOL	WYE/DELTA	DOL
OUTLET SIZE	1/2"	1/2"	3/4"	3/4"	3/4"
MOTOR PHASE	1	3	1	3	1
DIMENSIONS	35x24x41	35x24x41	35x24x41	35x24x41	35x24x41
WEIGHT	438	438	467	467	467
	ERI0100003	ERI0150003	ERI0200003	ERI0250003	ERI0300003
RUNNING HP	10	15	20	25	30
CFM @ 110PSI	39.9	56.85	76.99	98.88	111.6
MAX PSI	145	145	145	145	145
DRIVE TYPE	BELT	BELT	BELT	BELT	BELT
MOTOR RPM	1750	1750	1750	1750	1750
START TYPE	WYE/DELTA	WYE/DELTA	WYE/DELTA	WYE/DELTA	WYE/DELTA
OUTLET SIZE	3/4"	1"	1"	1"	1"
MOTOR PHASE	3	3	3	3	3
DIMENSIONS	35x24x41	38x30x49	38x30x49	46x38x57	46x38x57
WEIGHT	467	546	546	878	878



BELT DRIVEN ROTARY SCREW AIR SERIES

5HP-25HP

- Programmable Logistic
- Controller
All EMAX rotary's are controlled by a user friendly Logika PLC. These controllers have many desirable features like: pressure adjustments, maintenance reminders, air differentials, master slave control and daily or weekly schedules.. Just to name a few.
- Our rotary's are extremely quite on their own but we also have sound proof materials within our locking side panels to ensure ultimate sound reduction.
- Long Life
- Our rotary's have a 70,000 hour life expectancy. Our competitors are only rated for around 25,000 hour.
- Single Phase power up to 30HP available in the variable speed series!



AVAILABLE ROTARY SCREW PACKAGES

- Expert Experience: Offering rotary screw compressors from 5HP-to 20HP!
- Innovative Product Design: EMAX offers rotary's in several configurations, tank less, tank mounted, or the complete package in our patented Swing Arm design
- Emax offers the best extended warranty plans.
- Quality Built: EMAX uses only name brand components on their rotary's. We use no Chinese parts. Our rotary pumps are made in Germany and Finland to
- precise specs. The electrical components are Schneider and all UL/CSA certified. We use only Premium Mann filters for optimum protection against harmful elements. We use 12 lead name brand motors.



DIRECT DRIVEN ROTARY SCREW AIR SERIES



30HP-400HP

- There are many advantages to going direct drive. They are user-friendly and will save time and money!
- Direct Drive lessens the load on the pump and motor bearings along with no belt maintenance!
- Direct Drive can produce air immediately without needing to fill the tank first.
- Paired with our TEFC motors these rotary screws are top of the line!
- Larger cabinets makes maintenance easier Spin-on/spin-off filters, Mann brand, non-proprietary
- Top mount exhaust cooling fan, enables quick and easy services, and installation of exhaust ducting
- Smart PLC including maintenance alarms to help extend the life of the compressor by reminding when and what needs serviced, along with fault alarms to allow for quick troubleshooting, daily automatic start / stop feature allowing for a compressor schedule to be set.
- Specially designed oil sump – many brands are designed to use a lot of oil, costing a lot to service, we have designed these to use 50% less oil, providing huge savings!
- 100% duty cycle
- VFD option on all – saves up to 40% in energy reduction!

VARIABLE SPEED ROTARY SCREW AIR SERIES

30HP-400HP

Reducing environmental impact is just another way EMAX Compressor is moving forward in the Air Compressor Industry. Our Variable Speed Rotary screws are equipped with the technology and engineering to have significant return on your investment and energy savings. Traditional fixed speed rotary screws operate at a constant speed, continuously switching to on and off to meet demand. This causes abrupt power loads leading to wasted energy. Variable Speed drives gradually increase the motors speed matching the demand reducing energy waste. This slower ramp up compared to on-off compressors dramatically reduces the starting current of the electric motor, this decreases stress on the motor, hence extending the life of the machine. You can save 25-70% on energy by using motor controls or variable frequency drives.

PREMIUM INDUSTRIAL AIR DRYERS

- Purifies compressed air by chilling to condense moisture
- High refrigerant safety
- Condensate is drained carrying oil and dirt particles away from the air
- Outlet air baffle heater - prevents condensation on outlet air piping
- Heavy duty steel cabinet
- Trouble free operation refrigerated air inlet inner cooler for high temp cooling
- Side mounted condenser & fan motor
- Environmentally friendly 134A refrigerant
- Pre-Plumbed
- 5 Micron Pre-Filter
- Built in 1 Micron Active Coalescing Filter
- Built in Auto Drain system - eliminates the need for daily maintenance
- Quick, easy to remove cabinet door for easy servicing - No screws!
- UL & CSA approved



30CFM -2000CFM

TECH SPECS

	EDRCF1150030	EDRCF1150058	EDRCF1150115	EDRCF1150144
CFM	30	58	115	144
PIPE SIZE	1/2"	3/4"	1 1/2"	1 1/2"
VOLTAGE 60HZ	115	115	115	115
AMPERAGE	4	7.2	11	14
DEW POINT (F)	37-50	37-50	37-50	37-50
MAX WORKING PSI	230	230	230	230
MAX INLET TEMP (F)	140	140	140	150
REFRIGERANT TYPE	134a	134a	134a	134a
MAX AMBIENT TEMP	122	122	122	120
	EDRCF230288	EDRCF460288	EDRCF230575	EDRCF460575
CFM	288	288	575	575
PIPE SIZE	2"	2"	3"	3"
VOLTAGE 60HZ	230 v-3 phase	460 v-3 phase	230 v-3 phase	460 v-3 phase
AMPERAGE	14	14	10	10
DEW POINT	37-50	37-50	37-50	37-50
MAX WORKING PSI	230	230	230	230
MAX INLET TEMP (F)	150	150	150	150
REFRIGERANT TYPE	134a	134a	134a	134a
MAX AMBIENT TEMP	120	120	120	120

REGENERATIVE DESICCANT COMPRESSOR AIR DRYER UP TO 260 CFM

- Low power consumption 115-240V single phase
- CE/UL approved
- Ambient air temp: Min 34F / Max 122F
- Inlet Temp: Min 40F / Max 120F
- Programmable controller, remote start-stop connection
- Can be mounted to the floor or wall with adjustable mounting brackets designed to remove moisture from compressed air by utilizing state of the art technology to obtain dewpoints of -40F and by appropriate de-rating -100F PDP.
- High quality components
- Quick and easy connections
- 2 Year warranty



TECH SPECS

	EDRDES1150025	EDRDES1150045	EDRDES1150110
CFM	25	45	110
INLET-OUTLET	1/2" NPT	1 1/2" NPT	1 1/2" NPT
INLET PRESSURE	60 MIN/230 MAX	60 MIN/230 MAX	60 MIN/230 MAX
AMBIENT TEMP	34 MIN/122 MAX	34 MIN/122 MAX	34 MIN/122 MAX
VOLTAGE	115V	115V	115V
WEIGHT	92	156	292



GAS AND DIESEL

STATIONARY, TRUCK MOUNT, AND TOWABLES



AIR

[ON THE GO]

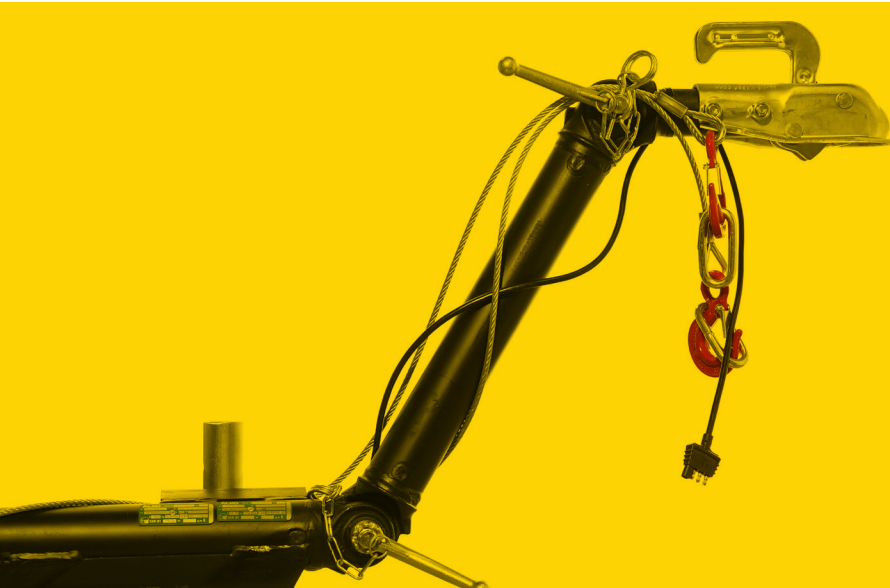

PROTECT IT!

1 YEAR STANDARD WARRANTY

10 YEAR EXTENDED WARRANTY

or



EXTENDED LIFETIME WARRANTY



GAS ROTARY SCREW



POWERED BY
KOHLER

- ROTARY SCREW
- PERFECT FOR MOBILE APPLICATIONS
- WEIGHS LESS THAN 400LBS
- 70CFM@100PSI
- MAX SET PSI IS 145
- COMPACT DESIGN FOR EASY MOBILITY
- EXTENDABLE / REVERSABLE HANDLE
- ELECTRIC START - BATTERY INCLUDED
- EASILY ACCESSABLE AIR OUTLETS AND FUEL TANK
- 24 HP KOHLER COMMAND PRO ENGINE
- FUEL THROTTLE REGULATION CONTROL FOR FUEL USAGE ON LOW AND HIGH DEMANDS

APPLICATIONS

- RENTAL
- JACKHAMMER
- SANDBLASTING
- DRY ICE BLASTING
- FIELD SERVICE TRUCKS
- CONSTRUCTION

TECH SPECS

HP	24 - KOHLER COMMAND PRO
CFM	70@100PSI / 62@145PSI
FUEL TANK	3 GALLON
MOTOR PHASE	GAS
DIMENSIONS	47" X 31" X 31"
WEIGHT	397LBS

EGS070PT



PROTECT IT!

1 YEAR
STANDARD
WARRANTY

or

10 YEAR
EXTENDED
WARRANTY

Go to pages 052 - 053

DIESEL ROTARY SCREW 90CFM



POWERED BY
 **Kubota**

- HEAVY DUTY BUT LIGHT WEIGHT AND WELL BALANCED
- QUIET OPERATING EXHAUST
- WEATHER-PROOF CANOPY
- LIQUID COOLED 3 CYL TOP RATED KUBOTA ENGINE
- COLD WEATHER STARTING GLOW PLUGS
- VARIABLE SPEED ON DEMAND ENGINE CONTROL
- PROVEN GERMAN MADE (SINCE 1939) ROTARY SCREW PUMP
- 100% DUTY CYCLE
- EASY SPIN ON/OFF MANN BRAND FUEL, OIL, AND AIR FILTERS
- LARGE RADIATOR COOLING CAPACITY
- ADJUSTABLE HITCH
- TRAILER OPTION THAT IS DOT CERTIFIED FOR HIGHWAY USE (INCLUDES TITLE FOR REGISTRATION)
- LARGE LED TAILLIGHTS
- HOT DIPPED GALVANIZED UNDER SUSPENSION/ GRILL, BALL HITCH ATTACHMENT, TAIL LIGHT, AND INSTRUMENT PANEL

TECH SPECS

HP	24 - KUBOTA ENGINE
CFM	90
MAX PSI	125
FUEL TANK	11 GALLON
MOTOR	DIESEL
DIMENSIONS	STATIONARY (59.5" X 30" X 39") TRAILER (116" X 47" X 52.5")
WEIGHT	STATIONARY: 974 TRAILER: 1168

TRUCK MOUNTED
EDS090ST

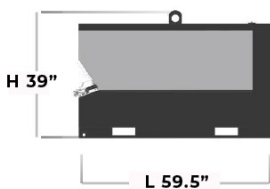

TRAILER MOUNTED
EDS090TR

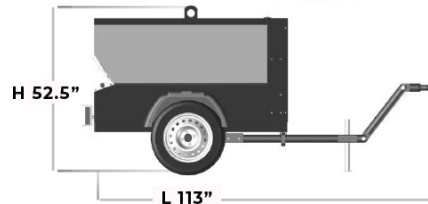

DIESEL ROTARY SCREW 115CFM



POWERED BY
 **Kubota**

- HEAVY DUTY BUT LIGHT WEIGHT AND WELL BALANCED
- QUIET OPERATING EXHAUST
- WEATHER-PROOF CANOPY
- LIQUID COOLED 3 CYL TOP RATED KUBOTA ENGINE
- COLD WEATHER STARTING GLOW PLUGS
- VARIABLE SPEED ON DEMAND ENGINE CONTROL
- PROVEN GERMAN MADE (SINCE 1939) ROTARY SCREW PUMP
- 100% DUTY CYCLE
- EASY SPIN ON/OFF MANN BRAND FUEL, OIL, AND AIR FILTERS
- LARGE RADIATOR COOLING CAPACITY
- ADJUSTABLE HITCH
- TRAILER OPTION THAT IS DOT CERTIFIED FOR HIGHWAY USE (INCLUDES TITLE FOR REGISTRATION)
- LARGE LED TAILLIGHTS
- HOT DIPPED GALVANIZED UNDER SUSPENSION/ GRILL, BALL HITCH ATTACHMENT, TAIL LIGHT, AND INSTRUMENT PANEL

TECH SPECS

HP	24 - KUBOTA ENGINE
CFM	115
MAX PSI	125
FUEL TANK	11 GALLON
MOTOR	DIESEL
DIMENSIONS	STATIONARY (59.5" X 30" X 39") TRAILER (116" X 47" X 52.5")
WEIGHT	STATIONARY: 1005 TRAILER: 1202

TRUCK MOUNTED
EDS115ST

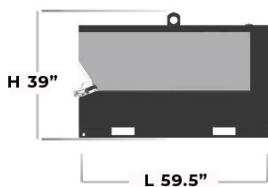

TRAILER MOUNTED
EDS115TR

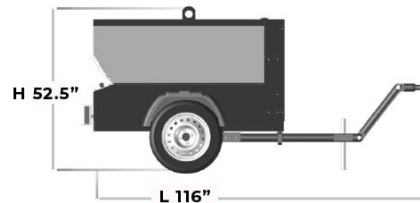

DIESEL ROTARY SCREW 185CFM



POWERED BY
 **Kubota**

- HEAVY DUTY BUT LIGHT WEIGHT AND WELL BALANCED
- QUIET OPERATING EXHAUST
- WEATHER-PROOF CANOPY
- TURBOCHARGED 4 CYL TOP RATED KUBOTA ENGINE
- COLD WEATHER STARTING GLOW PLUGS
- VARIABLE SPEED ON DEMAND ENGINE CONTROL
- ITALIAN MADE ROTARY SCREW PUMP
- 100% DUTY CYCLE
- EASY SPIN ON/OFF MANN BRAND FUEL, OIL, AND AIR FILTERS
- LARGE RADIATOR COOLING CAPACITY
- ADJUSTABLE HITCH
- TRAILER OPTION THAT IS DOT CERTIFIED FOR HIGHWAY USE (INCLUDES TITLE FOR REGISTRATION)
- LARGE LED TAILLIGHTS
- HOT DIPPED GALVANIZED UNDER SUSPENSION/ GRILL, BALL HITCH ATTACHMENT, TAIL LIGHT, AND INSTRUMENT PANEL

TECH SPECS

HP	45 - TURBOCHARGED KUBOTA ENGINE
CFM	185
MAX PSI	125
FUEL TANK	21 GALLON
MOTOR	DIESEL
DIMENSIONS	STATIONARY (69" X 35" X 44.5") TRAILER (122.5" X 52" X 59.5")
WEIGHT	STATIONARY: 1400 TRAILER: 1653

TRUCK MOUNTED
EDS185ST

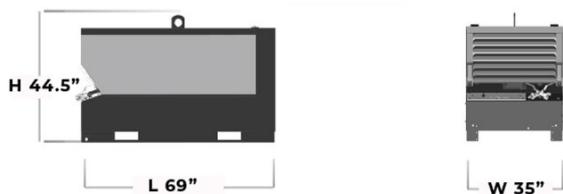

TRAILER MOUNTED
EDS185TR

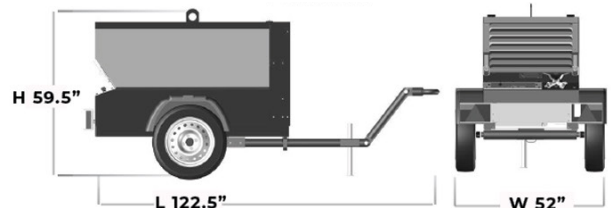

GAS DRIVEN SERIES

POWERED BY
KOHLER

- Kohler Command Pro series electric start gas engines
- Fuel tanks provided on all models
- OHV design provides excellent torque and fuel efficiency.
- Built in head unloaders for heavy duty cycles
- 2 Stage , Low RPM Pumps
- 5 year Full Warranty, 3 Year on Kohler Engine



TECH SPECS

	EGE24120ST*	EGES1330V4*
RUNNING HP	24	13
CFM 100PSI	57	31
MAX PSI	175	175
PUMP RPM	640	640
ENGINE RPM	3200	3200
ENGINE BRAND	KOHLER COMMAND PRO	KOHLER COMMAND PRO
OUTLET SIZE	3/4"	3/4"
AIR TANK SIZW	120 gal	30 GAL
FUEL TANK CAP	5 gal	1 GAL

3 IN 1 AIR COMPRESSOR WELDER/GENERATOR

- 14HP KOHLER® Command Pro Gas Engine with Electric Start
- Pressure Lubricated Two-Stage pump delivers a continuous flow of oil to critical engine components
- 5000W continuous run generator / 6000 surge watts
- Two 120V, 20 AMP Outlets / One 240 Volt Outlet
- Two-stage pump features industrial disc valves for extended life and easy maintenance
- Solid cast-iron pump provides maximum durability
- Liquid filled gauges
- Rubber vibration isolator pads
- Heavy duty steel belt guard
- 20 gallon ASME air tanks
- DC 190AMP stick welder with 50' leads
- DC jump starter
- Built-in regulator
- Quick disconnect



POWERED BY
KOHLER



PNEUMATIC TOOLS

POWER • PRECISION • PERFORMANCE



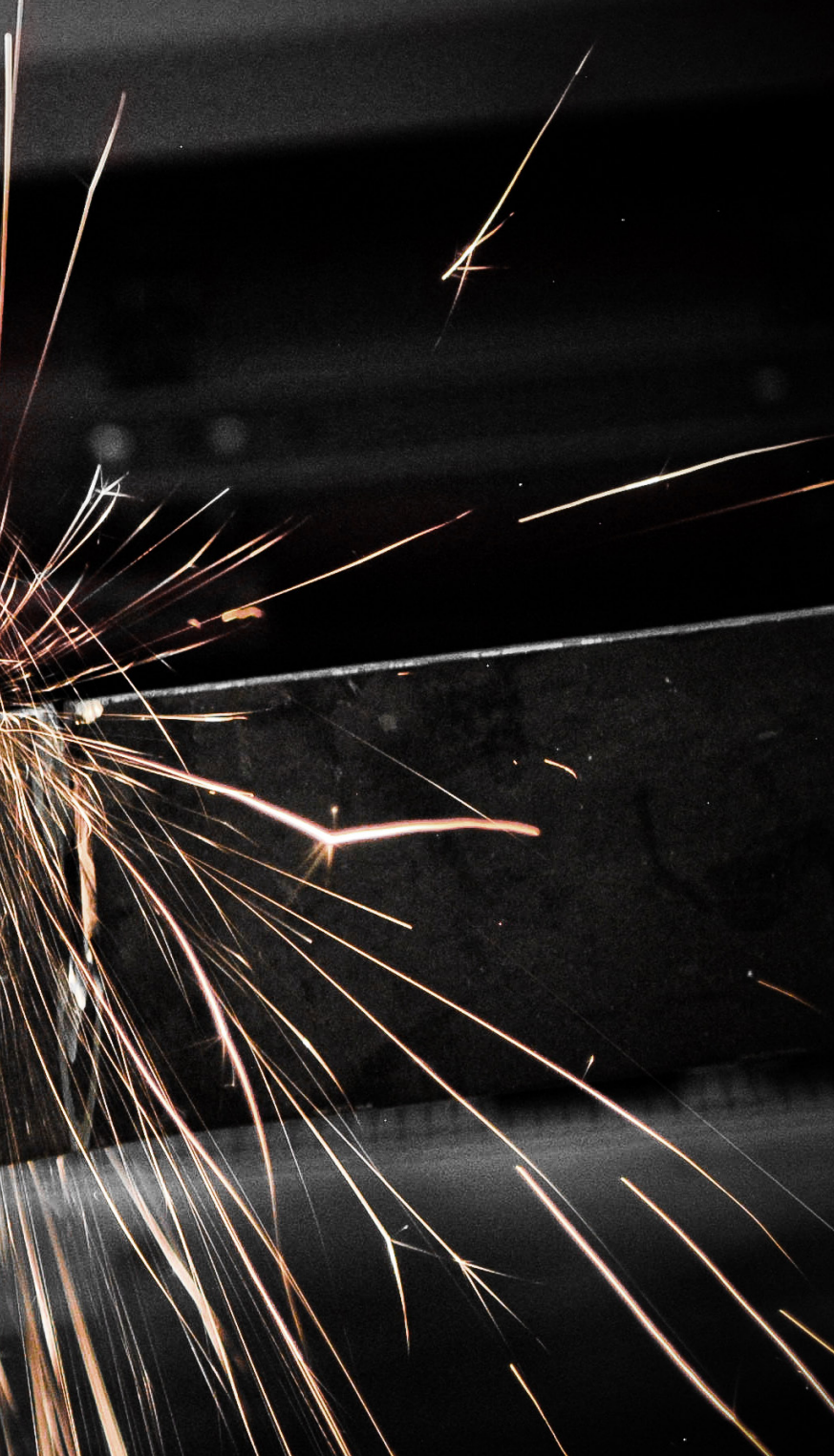

PROTECT IT!

**LIMITED LIFETIME
WARRANTY**

Go to pages 052 - 053



PNEUMATIC TOOLS

AIR TOOLS WITH A LIFETIME WARRANTY

EMAX Pneumatic Air Tools out last the rest with their power, performance, precision and their lifetime limited warranty! Our rugged construction offers features you need to get the job done in every industrial & commercial use.

EMAX incorporates industrial ball bearing construction and heat-treated internal cylinders, pistons and valves for optimum performance and extended tool life. Our construction has a built in silencing system that reduces shock and minimizes fatigue, makes the use of these air tools a pleasant experience.



PROTECT IT!



IMPACT TOOLS

EATIWH1S1P	Industrial 1" Impact Wrench (Clutching Type: Rocking Dog)
EATIWC1S1P	Industrial 1" Impact Wrench (Clutching Type: Twin Hammer)
EATIWH3S1P	Industrial 3/8" Drive 430 ft. lbs. Composite Impact Wrench
EATIWC5S1P	Industrial 1/2" Drive 950 ft. lbs. Composite Impact Wrench
EATIW05S1P	Industrial 1/2" Drive 500 ft. lbs. Twin Hammer Air Impact Wrench
EATIWH5S1P	Industrial 1/2" Drive Premium 560 ft lbs. Twin Hammer Impact
EATIWH7S1P	Industrial 3/4" Extreme Duty 1,100 ft. lbs. Air Impact Wrench
EATRT03S1P	Industrial 3/8" Industrial Duty Air Ratchet
EATRT05S1P	Industrial 1/2" Industrial Duty Air Ratchet
EATRTH5S1P	Industrial 1/2" Extreme Duty extended Handle Air Ratchet

GRINDING TOOLS

EATAG02S1P	Industrial 1/4" Right Angle Air Powered Die Grinder
EATDG02S1P	Industrial 1/4" Straight Shaft Air Powered Die Grinder
EATAG40S1P	Industrial 4" Heavy Duty Air Angle Grinder



**RUGGED
AND RELIABLE**

SANDING TOOLS

EATOS30S1P	Industrial Wet Sander
EATAS70S1P	Industrial 7" Extreme Duty Angle Air Sander
EATDS60S1P	Industrial 6" Dual Action Air Orbital Sander
EATJS80S1P	Industrial Random Orbital Air Jitterbug Sander
EATOS50S1P	Industrial 5" 3-in-1 Multi-Function Vacuum Orbital Air Sander
EATOS60S1P	Industrial 6" Random Orbital Air Sander with vacuum

DRILLING TOOLS

EATDR03S1P	Industrial 3/8" Reversible Air Drill
EATDR05S1P	Industrial 1/2" Reversible Air Drill

HAMMERING-CHISELING-CUTTING TOOLS

EATHM70K9P	Industrial Low Vibration Air Hammer Kit - 3000 BPM
EATHM80S1P	Industrial Composite Vibration-Dampening Air Hammer - 3000 BPM
EATHM10S1P	Industrial Composite Vibration Dampening Extended Air Hammer - 2100 BPM
EATBS10S1P	Industrial Air Body Saw - Uses standard air saw blades
EATCO30S1P	Industrial High Speed 3" Air Cut Off Tool



SPRAY GUNS

POWER • PRECISION • PERFORMANCE





Snap Lids®

THE BENEFITS OF USING THE SNAP LID SYSTEM

- Fastest system; save time and money by using the mixing cup as a paint cup
- Easy-to-use; complete system with attuned components
- For all types of paint; four filters available for clear coatings, waterborne coatings, conventional based coatings and primers.
- For all types of spray guns; matching adapter for almost all types of spray guns
- Unique valve system; prevents a vacuum and guarantees a stable paint flow
- Reinforced lid; for fast and easy closure and leak prevention
- Secure and tight thread; for a stable and watertight connection to the spray gun

® The above brands are registered trademarks of COLAD





PROTECT IT!

LIMITED LIFETIME WARRANTY

Go to pages 052 - 053

EATSPGPSIP

Primer/Surface, Finish sanding required, Tip size 1.8, Entry Level PRO, Will work with larger tip and cap size.

AVERAGE AIR
CONSUMPTION
3.6 CFM

WORKING
PRESSURE
3.0

AIR INLET
1/4" NPT



EATSPGPEIP

Primer/Sealer, Tip Size 1.3, Entry Level PRO, smaller body style gun.

AVERAGE AIR
CONSUMPTION
3.6 CFM

WORKING
PRESSURE
2.0-3.0

AIR INLET
1/4" NPT



EATSPGMFIP

Metallic, Finish paint, Tip size 1.3, Mid Tier Pro, HVLP Premium Performance.

AVERAGE AIR
CONSUMPTION
7-10 CFM

WORKING
PRESSURE
2.0-3.0

AIR INLET
1/4" NPT



SPRAYGUNS

FEATURES / SPECS

FROM START TO FINISH

EATSPGSFIP

Solid Finish Paint Tip Size 1.3, Mid Tier PRO, Premium Performance.

AVERAGE AIR
CONSUMPTION

5.8 CFM

WORKING
PRESSURE

2.0-3.0

AIR INLET

1/4" NPT



EATSPGPCIP

Clear coat tip size 1.3, Premium Pro, HVLP highest performance.

AVERAGE AIR
CONSUMPTION

7-10 CFM

WORKING
PRESSURE

2.0-3.0

AIR INLET

1/4" NPT



EATSPGTU1P

Touch Up Gun, Tip Size 1.1, Mid Tier PRO, mini body style gun.

AVERAGE AIR
CONSUMPTION

3.0 CFM

WORKING
PRESSURE

2.0-3.0

AIR INLET

1/4" NPT





Colad

THE BENEFITS OF USING THE SNAP LID SYSTEM

- Fastest system; save time and money by using the mixing cup as a paint cup
- Easy-to-use; complete system with attuned components
- For all types of paint; four filters available for clear coatings, waterborne coatings, conventional based coatings and primers.
- For all types of spray guns; matching adapter for almost all types of spray guns
- Unique valve system; prevents a vacuum and guarantees a stable paint flow
- Reinforced lid; for fast and easy closure and leak prevention
- Secure and tight thread; for a stable and watertight connection to the spray gun

® The above brands are registered trademarks of COLAD





Colad Mixing Cups for paint preparation are made of polypropylene. Because of the clearness of the cups the paint content and the mixing ratios are very visible from the inside of the cup.

It is designed for one time use, save cleaning time with the Colad disposable Mixing Cup.



- AVAILABLE IN FIVE SIZES
- COMPATIBLE WITH VARIOUS PAINT APPLICATION SYSTEMS
- SOLVENT RESISTANT
- ANTI-STATIC

- STACKABLE TO SAVE SPACE
- PRECISION PRINTED WITH 11 ACCURATE MIXING RATIOS:
- 1:1, 2:1, 3:1, 4:1, 5:1, 6:1, 7:1, 8:1, 9:1, 10:1, 11:1. *350 ml has 8 mixing ratios.
- 2 MEASURING SCALES in millilitres and fluid ounces.
- FLAT BOTTOM



MIX

- Liner-free cup design: Mix directly in the Snap Lid® mixing cup and use as a paint cup, all in one!
- All industry-standard mixing ratios printed directly on the cup
- Available Turbomix Paintsaver® speeds up mixing and reduces paint waste



SNAP

- Vented Snap Lid® attaches directly to the precision-matched mixing/paint cup
- Fast and easy "snap" assembly for a leak-proof seal
- Two built-in removable filter options: 130UM and 190UM

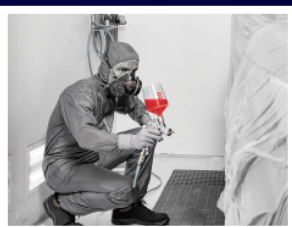

GO

- Vented paint cup performance
- Reinforced lid for a secure closure and leak prevention
- Threaded solid connection to the spray gun

COLAD KITS:
CUPKIT001 & CUPKIT002



HULK POWER BY EMAX



TECH SPECS

Low RPM, low AMP draw motors with solid copper windings for longer life

Silent Air low RPM, 2 cylinder commercial grade pumps plus heavy gauge steel cylinders, cylinder heads and valves.

Commercial Grade Engineered components; pressure switches, stainless steel transfer tubes, brass quick couplers, gate valve tank drains combined with heavy gauge steel construction for maximum durability & reliability

	HP01P006SS	HP02P010SS	HP02P020SS
MOTOR HP	1 HP	2 HP	2 HP
DESCRIPTION	1 HP 6 GAL OILFREE SILENT PORTABLE	2 HP 10 GAL OILFREE SILENT PORTABLE	2 HP 20 GAL OILFREE SILENT PORTABLE
CFM @ 90 PSI	3.14	5.77	5.77
CFM @ 40 PSI	4.87	8.39	8.39
MAX PSI	120	125	125
TANK SIZE	6 GAL	10 GAL	20 GAL
NOISE DBA	45 DB @ 3 FT	61 DB @ 3 FT	61 DB @ 3 FT

	HP15P004SS	HP01P005SS	HP15P005SS	HP01P002SS
MOTOR HP	1 HP	1 HP	1.5 HP	1 HP
DESCRIPTION	1 HP 4 GAL OILFREE SILENT TWIN STACK	1 HP 5 GAL OILFREE SILENT SIDE STACK	1 HP 5 GAL OILFREE SILENT SIDE STACK	1 HP 2 GAL OILFREE SILENT SIDE STACK
CFM @ 90 PSI	2.69	2.59	3.24	2.54
CFM @ 40 PSI	3.92	3.91	5.29	3.72
MAX PSI	120	125	125	120
TANK SIZE	4 GAL	5 GAL	5 GAL	2 GAL
NOISE BDA	41 DB @ 3FT	37 DB @ 3FT	37 DB @ 3 FT	36 DB @ 3 FT



HULK 5HP & 7.5HP

3 CYLINDER COMMERCIAL AIR COMPRESSOR WITH 80 GALLON TANK

- WHISPER 100 SILENT AIR NOISE SUPPRESSION SYSTEM WITH 5-STAGE INTAKE FILTRATION
- TANK DRAIN EXTENDED VALVE MAGNETIC STARTER
- 1750 LOW RPM INDUSTRIAL ODP ELECTRIC MOTOR
- 80 GALLON ASME CERTIFIED TANK
- SOLID CAST IRON, 2-STAGE, 3 CYLINDER, LOW RPM PUMP
- INDUSTRIAL DISC VALVES
- OIL DRAIN VALVE
- 2-V STYLE BELTS-B GROOVE
- 1 3 GAUGE STEEL BELT GUARD
- 4 YEAR FULL WARRANTY



HULK air compressors deliver overwhelming performance to ensure that they meet the needs of even the most demanding environments. All products are designed with exacting tolerance and specifications to deliver all the power that's needed at the job site, garage or shop, for extreme performance.

HULK silent air compressors are designed to deliver high air power output with little noise. These commercial-grade pumps are designed with heavy gauge steel cylinders, cylinder head and valves for maximum durability and reliability.

TECH SPECS

	HI05V080Y1S	HI07V080Y1S
RUNNING HP	5	7.5
CFM 100PSI	18	26
MAX PSI	175	175
PUMP MODEL	APP3Y0722T	APP3Y0722T
PUMP RPM	680	800
MOTOR RPM	1750	1750
DBA AVG RATING	57	67
OUTLET SIZE	3/4"	3/4"
MOTOR PHASE	SINGLE 230V	SINGLE 230V



EXTENDED LIFETIME PISTON PUMP WARRANTY

At EMAX Compressor, we refer to our worry-free Extended Lifetime Pump Warranty as our "Preventative Maintenance Initiative" that serves as a regular reminder that your EMAX air compressor requires an oil and filtration change, to ensure it continues to provide years of reliable service.

Benefits

When you choose the Extended Lifetime Pump Warranty, we'll send you air filters for both your air compressor, as well as

the Whisper 100 Silencer Unit, if applicable, along with our genuine Airbase Industries Whisper Blue Smart Oil so that you have what you need to service your compressor on a scheduled basis.

Why is it called the best warranty in the industry?

If a pump failure occurs at any time during the Extended Lifetime Pump Warranty period, we will send the replacement part required to fix the pump assembly, in order to keep your business running smoothly.

OUR STANDARD WARRANTY POLICY

Each EMAX Compressor comes with our standard warranty policy. Our standard warranty policy covers all defects in workmanship or materials. During the first 90 days of the policy EMAX will cover shipping for any warranty claims. Our standard technical assistance is provided during and after your warranty period.



STANDARD

EXTENDED WARRANTY POLICIES

EMAX offers different levels of extended warranty plans to best fit the customers needs. Extended plans vary by which EMAX product is purchased. Extended

warranty plans include our advanced technical Smart Air support providing the highest level of support! Smart Tech support is an interactive support team available to you at your fingertips by just downloading a free app. The app provides free remote meetings, interactive touch display, real live personal to assist. All of our plans include warranty labor cost as well.



EXTENDED

HOW TO GET AN EXTENDED WARRANTY?

EMAX makes it easy! Just register your compressor on our website, pick and enroll in one of our plans and your covered!



PEACE OF MIND

Purchasing an air compressor is a significant investment! Protect your equipment and budget against unexpected maintenance and downtime.

EMAX Compressor's warranty program offers you extended warranty plans that fit your needs and budget to provide you with peace of mind.

WWW.EMAXWARRANTY.COM

WHAT IS NOT COVERED?

The warranty applies only to the original purchasers and may not be transferred. The warranty only covers defects that arise under normal usage and does not cover malfunction, failure or defect resulting from misuse, abuse, neglect, alteration, modification or acts of nature. Labor charges for repairs or maintenance made by person(s) other than an authorized, approved service technician or any labor after the 1-year Standard Warranty expires. Normal wear and tear parts.

REGISTER

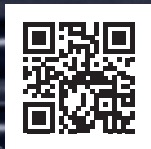

 **EMAX**
AIR TECHNOLOGY



EXTENDED WARRANTY

MAINTENANCE KITS

EMAX PISTON ELECTRIC AIR COMPRESSORS

EXTENDED WARRANTY MAINTENANCE KITS - DESCRIPTION

	1YR	5YR	Lifetime Pump
Extended Warranty Filter Kit for 5hp - 10hp Piston Compressors	FKIT008	FKIT008WB	FKIT026
Extended Warranty Filter Kit for 15hp - 20hp Piston Compressors	FKIT009	FKIT009WB	FKIT027
Extended Warranty Filter Kit for 25hp Piston Compressors	FKIT010	FKIT010WB	FKIT028
Extended Warranty Filter Kit for 5hp - 10hp Piston Compressors with Silencers	FKIT008A	FKIT008AWB	FKIT026A
Extended Warranty Filter Kit for 15hp - 20hp Piston Compressors with Silencers	FKIT009A	FKIT009AWB	FKIT027A
Extended Warranty Filter Kit for 25hp Piston Compressors with Silencers	FKIT010A	FKIT010AWB	FKIT028A

EMAX PISTON GAS ENGINE DRIVEN AIR COMPRESSORS

EXTENDED WARRANTY MAINTENANCE KITS - DESCRIPTION

	1YR	5YR	Lifetime Pump
Warranty Kit for 8HP & 13HP 2 CYL Gas driven Compressors, Includes Synthetic Piston Oil, air filters	FKIT046	FKIT047	FKIT050
Warranty Kit for 13HP V4 Gas driven Compressors, Includes Synthetic Oil, air filters	FKIT035	FKIT033	FKIT030
Warranty Kit for 14HP Gas driven Compressors, Includes Synthetic Piston Oil, air filters	FKIT038	FKIT039	FKIT040
Warranty Kit for 18HP V4 Gas driven Compressors, Includes Synthetic Piston Oil, air filters	FKIT036	FKIT034	FKIT031
Warranty Kit for 24HP Gas driven Compressors, Includes Synthetic Piston Oil, air filters	FKIT037	FKIT032	FKIT029



EMAX ROTARY SCREW ELECTRIC AIR COMPRESSORS

EXTENDED WARRANTY Maintenance Kits - Description	1YR	10YR	LIFETIME Air End
Extended Warranty Kit for 7.5 to 10 HP (T) Rotary Screw Compressor (SN DRIVEN)	SKIT001	SKIT001WB	
Extended Warranty Kit for 5-10 HP (T) Rotary Screw Compressor (SN DRIVEN)	SKIT001A	SKIT001AWB	SKIT001AWBSM
Extended Warranty Kit for 7.5 to 10 HP (T) Rotary Screw Compressor (FOOD GRADE)	SKIT002		
Extended Warranty Kit for 7.5 to 10 HP (T) Rotary Screw Compressor (FOOD GRADE)	SKIT002A		
Extended Warranty Kit for 15 to 20 HP (T) Rotary Screw Compressor	SKIT003	SKIT003WB	SKIT003WBSM
Extended Warranty Kit for 15 to 20 HP (T) Rotary Screw Compressor (Food Grade)	SKIT004		
Extended Warranty Kit for 25-30 HP (T) Rotary Screw Compressor	SKIT005	SKIT005WB	SKIT005WBSM
Extended Warranty Kit for 25 to 30 HP (T) Rotary Screw Compressor (FOOD GRADE)	SKIT006		
Extended Warranty Kit for 40HP DD(T) Rotary Screw Compressor	SKIT028	SKIT028WB	SKIT028WBSM
Extended Warranty Kit for 40 to 60 HP (T) Rotary Screw Compressor (SN DRIVEN)	SKIT007	SKIT007WB	
Extended Warranty Kit for 40 to 60 HP (T) Rotary Screw Compressor (SN DRIVEN)	SKIT021	SKIT021WB	
Extended Warranty Kit for 50-60HP DD(T) Rotary Screw Compressor	SKIT029	SKIT029WB	SKIT029WBSM
Extended Warranty Kit for 75 to 100 HP (T) Rotary Screw Compressor	SKIT019	SKIT019WB	SKIT019WBSM
Extended Warranty Kit for 75 to 100 HP (T) Rotary Screw Compressors (FOOD GRADE)	SKIT020		
Extended Warranty Kit for 125-150 HP (T) Rotary Screw Compressor	SKIT026	SKIT026WB	SKIT026WBSM
Extended Warranty Kit for 175-200 HP (T) Rotary Screw Compressor	SKIT027	SKIT027WB	SKIT027WBSM

EMAX ROTARY SCREW GAS & DIESEL DRIVEN COMPRESSORS

EXTENDED WARRANTY Maintenance Kits - Description	1YR	10YR	LIFETIME Air End
EXTENDED WARRANTY Maintenance Kits - 2500 Series ST - STR Diesel	SKIT060	SKIT060WB	SKIT060WBSM
EXTENDED WARRANTY Maintenance Kits - 3000 Series ST - STR Diesel	SKIT061	SKIT061WB	SKIT061WBSM
EXTENDED WARRANTY Maintenance Kits - 5000 Series ST - STR Diesel	SKIT062	SKIT062WB	SKIT062WBSM
EXTENDED WARRANTY Maintenance Kits - Gas Series	SKIT063	SKIT063WB	SKIT063WBSM

SMART

DESIGNED FOR RECIPROCATION AIR COMPRESSORS



PISTON COMPRESSOR OIL

- MINIMIZE FRICTION & WEAR
- LOWER NOISE UP TO 10 DECIBELS
- INCREASE PUMP AND ENGINE LIFE
- REDUCE OPERATION TEMPERATURES
- IMPROVE FUEL SAVINGS UP TO 15%
- EXTREME HEAT & PRESSURE PERFORMANCE

UP TO 15%
ENERGY SAVINGS

SMART

DESIGNED FOR RECIPROCATION AIR COMPRESSORS

LUBRICATION TECHNOLOGY

USING SMART OIL™ IN ANY AIR-COOLED OR WATER-COOLED ENGINE WILL ENSURE UP TO 2X THE NORMAL BEARING LIFE AND EXTEND THE ENGINE WARRANTY.

SMART OIL™ ALSO IMPROVES HORSEPOWER PERFORMANCE BY UP TO 10%.

SMART OIL™ WORKS WITH ALL BRANDS OF AIR COMPRESSORS AND ALL PRODUCTS USING AIR-COOLED OR WATER-COOLED ENGINES.

- MINIMIZE FRICTION & WEAR • LOWER NOISE UP TO 10 DECIBELS
- INCREASE PUMP AND ENGINE LIFE • REDUCE OPERATION TEMPERATURES
- IMPROVE ENERGY SAVINGS UP TO 15% • EXTREME HEAT & PRESSURE PERFORMANCE

REMIUM

SERVICES

MERCHANT PROGRAM

WE ARE ACCEPTING NEW MERCHANTS!

Emax Compressor started to build its name in 1977. From our humble beginnings in a Boston, Indiana basement to supplying top quality compressors to well-known retailers all over the United States, Mexico, and Canada. We have built a quality brand, developed long term relationships with our customers, and continued to reach our goal of becoming one of the top selling compressor manufacturers.

EMAX offers the only domestically manufactured reciprocating air compressor program dedicated to drop shipments. Our proprietary just-in-time manufacturing

Process enables us to deliver the highest quality and value directly from factory to shop.



PHONE: 866.294.4153

Fax: (937) 540-1157

E-Mail: info@emaxcompressor.com

<https://emaxcompressor.com/merchant-program/>

SMART AIR SUPPORT

This cutting-edge way to solve any issues you may experience with its unique

"see-what-you-see" technology using your smart phone. This is tech support 2.0! No matter how far away our customer may be with Smart Air Tech Support, we're able to see through our customers smartphone

camera and guide them, even setting 3D markers on their compressors to collaborate with them to repair the issue.

Our virtual tech support helps avoid delays in repairs and lessen downtime. Our team is ready to provide direct support via audio and video with a quick download of an APP.





SERVICE AND PARTS

THE BEST SUPPORT IN THE INDUSTRY

EMAX Compressor provides the best support in the industry. We have an amazing team on the road and in our call center ready to help!

Our Smart air support allows us to provide trouble shooting and guidance virtually, as if we were right on-site!

Call us at 1-866-294-4153





EMAX



VISIT US ONLINE AT:
WWW.EMAXCOMPRESSOR.COM

