



TANKLESS GAS WATER HEATER



BW SERIES PORTABLE TANKLESS GAS

WATER HEATER

USE & CARE MANUAL

WITH INSTALLATION INSTRUCTIONS FOR THE INSTALLER

Note: Before using, please read this manual through carefully and keep this manual in a safe place for future reference. Instrations shown in this manual are for reference only, please prevail in kind.

Any questions regarding the operation, maintenance service or warranty of this water heater should be directed to Camplux, please contact via email at junskycustomerservice@outlook.com

Introduction	1
General Safety	2-4
Benefits and Features	5-7
Installation Guide	
Getting Started.....	7-8
In The Box.....	8-9
How To Use The Garden Hose	9-11
Use And Starting.....	11-12
Adjustment.....	12-13
Troubleshooting Guide.....	13-15
Service & Warranty Information.....	15

READ THIS MANUAL

Inside you will find many helpful hints on how to use and maintain your water heater properly. A little preventive care on your part can save you time and money over the life of your water heater. You'll find many answers to common problems in the Troubleshooting Guide. If you review the chart of Troubleshooting Tips first you may not need to call for service.

READ THE SAFETY INFORMATION

Your safety and the safety of others are very important. There are many important safety messages in this manual and on your appliance. Always read and obey all safety messages. This is the safety alert symbol. Recognize this symbol as an indication of Important Safety Information! This symbol alerts you to potential hazards that can kill or hurt you and others.

All safety messages will follow the safety alert symbol and the words: **“DANGER”**, **“WARNING”**, **“CAUTION”** or **“NOTICE”**.

These words mean:

 **DANGER** – An imminently hazardous situation that will result in death or serious injury.

 **WARNING** – A potentially hazardous situation that could result in death or serious injury and/or damage to property.

 **CAUTION** – A potentially hazardous situation that may result in minor or moderate injury.

 **NOTICE** – Attention is called to observe a specified procedure or maintain a specific condition.

IMPORTANT SAFETY INFORMATION READ ALL INSTRUCTIONS BEFORE USING

Be sure to read and understand the entire Use and Care Manual before attempting to install or operate this water heater. It may save you time and money. Pay particular attention to the Safety Instructions. Failure to follow these warnings could result in serious bodily injury or death. Should you have problems understanding the instructions in this manual, or have any questions, STOP, and get help from a qualified service technician, or the local gas utility.

DANGER!

WATER TEMPERATURE SETTING

Safety and energy conservation are factors to be considered when selecting the water temperature setting. Water temperatures above 122°F (50°C) can cause severe burns or death from scalding. The thermostat is adjusted to its lowest temperature position when shipped from the factory. Be sure to read and follow the warnings outlined on the label pictured below.

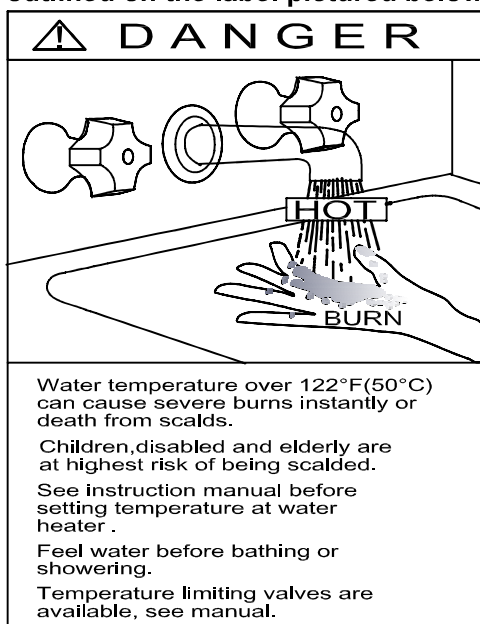

Time/Temperature Relationship in Scalds		
Water Temperature		Time To Produce a Serious Burn
120°F	49°C	More than 5 minutes
122°F	50°C	1 1/2-2 minutes
130°F	54°C	About 30 seconds
135°F	57°C	About 10 seconds
140°F	60°C	Less than 5 seconds
145°F	63°C	Less than 3 seconds
150°F	66°C	About 1 1/2 seconds
155°F	68°C	About 1 second

Table courtesy of Shriners Burn Institute

The chart shown above may be used as a guide in determining the proper water temperature for your home.

DANGER!

PROPERLY INSTALL WATER HEATER

Failure to properly install the water heater outdoors as outlined in the Installation Instructions in this manual can result in unsafe operation of the water heater. To avoid the risk of fire, explosion, or asphyxiation from carbon monoxide, never operate this water heater unless it is installed properly and has an adequate air supply for proper operation. Be sure to inspect the flue terminal for proper installation at initial start-up and at least annually thereafter. Refer to the Care and Cleaning section of this manual for more information regarding flue terminal inspection.

WARNING!

Gasoline, as well as other flammable materials and liquids (adhesives, solvents, paint thinners etc.), and the vapors they produce are extremely dangerous. DO NOT handle, use or store gasoline or other flammable or combustible materials anywhere near or in the vicinity of a water heater or any other appliance. Be sure to read and follow the labels on

the water heater, as well as the warnings printed in this manual. Failure to do so can result in property damage, bodily injury or death.

 **DANGER**

FLAMMABLES

Flammable Vapors



▲ Vapors from flammable liquids will explode and catch fire causing death or severe burns.

Do not use or store flammable products such as gasoline, solvents or adhesives in the same room or area near the water heater.

Keep flammable products:

1. far away from heater,
2. In approved containers,
3. tightly closed and
4. out of children's reach.

Water heater has a main burner flame.

The main burner flame:

1. which can come on at any time and
2. will ignite flammable vapors.

Vapors:

1. cannot be seen,
2. are heavier than air,
3. go a long way on the floor and
4. can be carried from other rooms to the main burner flame by air currents.

Installation :

Do not install water heater where flammable products will be stored or used unless the main burner flame is at least

18" above the floor. This will reduce, but not eliminate, the risk of vapors being ignited by the main burner flame.

Read and follow water heater warnings and instructions. If owners manual is missing, contact the retailer or manufacturer.

 **DANGER!**

LIQUEFIED PETROLEUM MODELS

LP gas have an odorant added to aid in detecting a gas leak. Some people may not physically be able to smell or recognize this odorant. If you are unsure or unfamiliar with the smell of LP gas, ask the gas supplier. Other conditions, such as "odorant fade," which causes the odorant to diminish in intensity, can also hide or camouflage a gas leak. Always check with commercial leak detector or soapy water.

- **Gas detectors are recommended in LP gas applications and the installation should be in accordance with the detector manufacturer's recommendations and/or local laws, rules, regulations or customs.**

- Water heaters utilizing LP gas are different from natural gas models. A natural gas water heater will not function safely on LP gas and vice versa.

- No attempt should ever be made to convert the water heater from LP gas to natural gas. To avoid possible equipment damage, personal injury or fire, do not connect the water heater to a fuel type not in accordance with the portable tankless water heater data plate.

- LP appliances should not be installed below grade (for example, in a basement) if such installation is prohibited by federal, state and/or local laws, rules, regulations or customs.

- Propane or LP gas must be used with great caution. It is heavier than air and will collect first in lower areas making it hard to detect at nose level.

- Before attempting to light the water heater, make sure to look and smell for gas leaks. Use a soapy solution to check all gas fittings and connections. Bubbling at a connection indicates a leak that must be corrected. When smelling to detect a gas leak, be sure to sniff near the floor also.

- It is recommended that more than one method, such as soapy solution, gas detectors, etc., be used to detect leaks in gas applications.

 **NOTICE:** If a gas leak is present or suspected:

- **DO NOT attempt to find the cause yourself.**
- **DO NOT try to light any appliance.**
- **DO NOT touch any electrical switch.**
- **DO NOT use any phone in your building.**
- **Leave the house immediately and make sure your family and pets leave also.**
- **Leave the doors open for ventilation and contact the gas supplier, a qualified service agency or the fire department.**
- **Stay away from the house (or building) until the service call has been made, the leak is corrected and a qualified agency has determined the area to be safe.**

 **ADDITIONAL WARNINGS**

1. Do not leave unattended.
2. The exhaust gas and top of the portable tankless water heater is **HOT!** Do not place hands or any foreign object near the top of the heater.
3. Do not use in high wind conditions. For safety reasons the heater will not start in sustained wind, find an alternate location for the water heater.
4. If the smell of gas is detected, turn off the gas valve at the tank immediately! Do not use flame for leak detection.
5. Use only Liquid Propane.
6. Intended for outdoors use, can be installed indoor if a flue pipe or duct is installed and ventilation is guaranteed.
7. Do not over tighten the gas regulator connection to the portable tankless water heater with a wrench. This may cause a crack in the gas regulator.

 **WARNING: California Proposition 65**

This appliance contains chemicals known to the State of California to cause cancer, birth defects, or other reproductive harm.

If the information in these instructions is not followed exactly, a fire or explosion may result causing property damage, personal injury or death.

Do not discard this manual. Please read carefully and keep in a safe place for future reference.

The Purpose and Benefits of the BW Series

The Camplux BW series is a liquid propane fired water heater capable of delivering 1.58/2.11/2.64/3.18/4.22 gallons of hot water almost anywhere. The portable tankless water heater has standard 1/2" BSP pipe fittings and CAMPLUX supplied GHT adapters for using a standard garden hose for inlet water supply.

The Camplux BW series gas water heater is not a toy. People around the world use similar portable tankless water heaters to heat the water around their homes, safely, and reliably. Gas is supplied from a standard 20 pound propane cylinder (not included) such as used with outdoor grills. A regulator with hose is furnished with the heater.

A shower head with on/off switch and multiple spray patterns is included.

Ignition is automatic and powered by 2 "D" cell batteries (not included). Burners come on when water flows, and off when the water is shut off. No pilot light.

Ideal operating use with water pressure between 2.5–110 PSI (BW158) / 3.0 -110PSI (BW211)/3.6-110PSI(BW264)/3.8-110PSI(BW318)/4.0-110PSI(BW422).

Functions and Features

- **Water controlled automatic ignition:** Water pressure between 2.5–3.0PSI and 0.4–0.8GPM(BW158), 3.0-5.0PSI and 0.45-0.90GPM(BW211), 3.6-6.4 PSI and 0.62 -1.45 GPM (BW264), 3.8-7.8PSI and 0.64-1.45 GPM(BW318), 4.0-7.2 PSI and 0.77 -1.72GPM (BW422). opens the ignition circuit for easy and convenient operation.
- **Auto-cut-off protection:** The auto cut-off protection will shut the gas supply off immediately in the event of flameout to reduce the risk of gas leakage.
- **Removable drain valve to avoid water pipe and regulator damage caused by freezing water.**
- **Anti-dry combustion protection:** The portable tankless water heater will shut off the gas supply in the event water stops flowing through the portable tankless water heater.

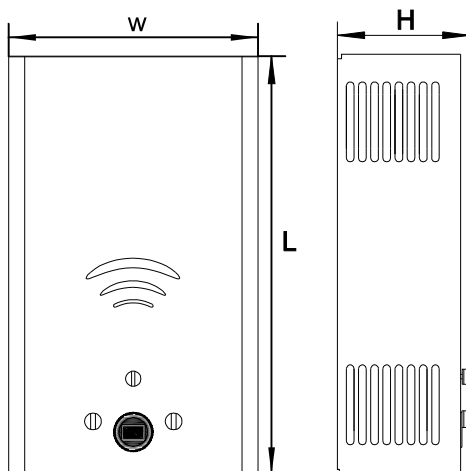

BW158:440(17.3")X300(11.8")X138(6.1")

BW211:520(20.5")X320(12.6")X168(6.6")

BW264:550(21.6")X330(13.0")X188(7.4")

BW318:610(24.0")X400(15.8")X188(7.4")

BW422:700(27.6")X440(17.3")X200(7.9")

***Read the maintenance section on draining the portable tankless water heater entirely to avoid freeze issues.**

TEMPERATURE INCREASE PER GPM					
MODEL	GAS SETTING	0.5GPM	1.0GPM	1.5GPM	2.0GPM
BW158	HIGHEST	75°C/167°F	38°C/100°F	25°C/77°F	19°C/66°F
	LOWEST	34°C/93°F	17°C/63°F	11°C/52°F	9°C/48°F
MODEL	GAS SETTING	1.5GPM	2.0GPM	2.5GPM	2.64GPM
BW211	HIGHEST	75°C/167°F	50°C/122°F	35°C/95°F	25°C/77°F
	LOWEST	36°C/97°F	23°C/73°F	17°C/63°F	9°C/48°F
MODEL	GAS SETTING	1.5GPM	2.5GPM	3.5GPM	4.22 GPM
BW264	HIGHEST	80°C/176°F	40°C/104°F	25°C/77°F	19°C/66°F
	LOWEST	40°C/104°F	20°C/68°F	14°C/57°F	9°C/48°F
MODEL	GAS SETTING	1.5GPM	2.0GPM	2.5GPM	3.18GPM
BW318	HIGHEST	80°C/176°F	45°C/113°F	30°C/86°F	20°C/68°F
	LOWEST	40°C/104°F	25°C/77°F	15°C/59°F	12°C/54°F
MODEL	GAS SETTING	1.5GPM	2.5GPM	3.5GPM	4.22 GPM
BW422	HIGHEST	85°C/185°F	50°C/122°F	35°C/95°F	25°C/77°F
	LOWEST	34°C/93°F	28°C/82°F	17°C/63°F	13°C/55°F

***Temperature increases listed are based on use of the water heater under optimal conditions. Variable factors such as incorrect or imperfect installations and varying incoming water temperatures may yield different results.**

TECHNICAL SPECIFICATIONS					
MODEL	BW158	BW211	BW264	BW318	BW422
BTU/H	41,000 BTU/Hr	55,000 BTU/Hr	68,000 BTU/Hr	82,000 BTU/Hr	110,000 BTU/Hr
DIMENSIONS	17.3"X11.8"X5.4"	20.5"X12.6"X6.6"	21.6"X13"X7.4"	24.0"X13.8"X7.4"	27.6"X17.3"X7.9"
ACTIVATION FLOW RATE	0.40 GPM	0.50 GPM	0.62 GPM	0.64 GPM	0.77 GPM
FUEL TYPE	LPG(Liquid Propane Gas)/Natural Gas				
RELATED GAS PRESSURE	0.4PSI(LPG)/0.25PSI(Natural Gas)				
IGNITION	Electric pulse, 2D cell battery powered (No electrical connection required)				
PROTECTIONS	Auto-cut off water control, automatic ignition, anti-dry combustion protection, over-pressure, over-heating and flameout protection				
PIPE FITTINGS	1/2" BSP for gas inlet, water inlet and water outlet				

Construction and parts for BW158/BW211/BW264/BW318/BW422

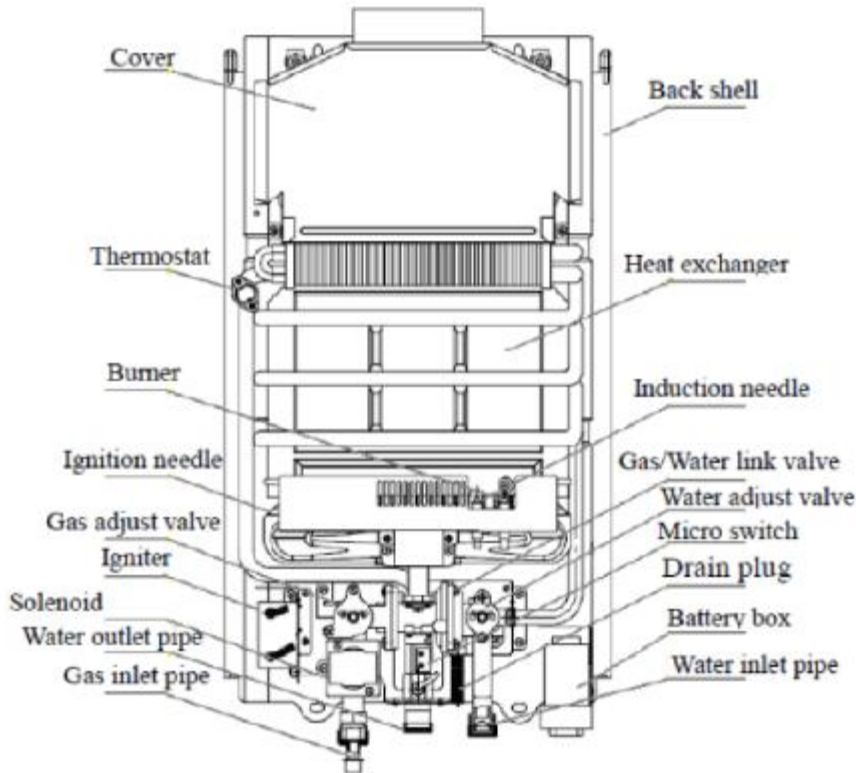

Getting Started

1. Check carton box for damage. Damages caused in shipment must be reported immediately.

2. Make sure you have all the parts.

Please note: Included parts and accessories may vary depending on country and regulations.

- a. **Tankless gas water heater**
- b. **ON/OFF switch shower head with 5 feet chrome hose**
- c. **Gas regulator with 5 feet hose**
- d. **Gas connector (fixed to inlet fitting already)**
- e. **1/2" BSP female X 3/4" GHT male, 1/2" BSP female X 3/4" GHT female to garden hose adapter**
- f. **Teflon tape**
- g. **Washer**
- h. **Fixing kits**

3. If using a standard garden hose, attach the 3/4" GHT garden hose adapter to the fitting marked "Water Input". Use Sealant tape or other approved sealing method on the threads for a secure, water tight fit. Check to make sure the screen inside the water inlet is in place and clean. Then attach your water input/garden hose.

4. Install gas supply line and regulator to the portable tankless water heater.
DO NOT OVER TIGHTEN. OVER TIGHTING MAY CRACK THE GAS REGULATOR CAUSING A GAS LEAK! Check for any gas smell before ignition! Make sure it is screwed all the way on.

5. Attach the shower head to the fitting marked 'Water Outlet. Do not over tighten.





6. Install two "D" cell batteries in the compartment on the bottom left of the heater. Check that batteries are facing the correct direction.

7. Use the top tab on the portable tankless water heater to suspend from a mounted screw capable of holding 30 pounds. Place at a comfortable height without putting stress on the gas hose.

8. Attach gas regulator with hose to the LP cylinder. Use hand pressure only on the plastic connector.

LEAVE GAS CYLINDER VALVE IN THE "OFF" POSITION.

In The Box

Description	Identification	Quantity	Remarks
Tankless Gas Water Heater		1 piece	
On/off switch shower head with 5 feet chrome hose		1 set	
CSA Gas regulator with 5 feet hose		1 set	Test for leaks after fitting
Gas connector (Fixed to inlet fitting already)		1 piece	1/2" BSP female X 5/8" NPT male flare

Garden hose		2 pieces	Left: 1/2" BSP female X 3/4" GHT male Right: 1/2" BSP female X 3/4" GHT female
Teflon tape		1 roll	
Washer		4 pieces	For garden hose
Fixing kits		1 set	

How To Use The Garden Hose

1. Garden Hose



GARDEN HOSE MALE

1/2" BSP FEMALE X 3/4" GHT MALE



GARDEN HOSE FEMALE

1/2" BSP FEMALE X 3/4" GHT FEMALE

NOTICE: MAKE SURE PUT THE RUBBER GASKET IN ALL FITTINGS BEFORE CONNECTION



2. Preparation

ONLY USE IN WELL-VENTILATED AREAS. CARBON MONOXIDE HAZARD-USING THIS APPLIANCE IN AN ENCLOSED SPACE WILL CAUSE DEATH-DO NOT USE IN CARAVANS, TENTS, MARINE CRAFT, CARS, MOBILE HOMES OR SIMILAR LOCATIONS.

- Use appliance only with LP (propane) gas and the regulator valve assembly supplied.
- Installation must conform with local codes, or in their absence with National Fuel Gas Code NFPA 54/ANSI Z223.1. Handling and storage of LP cylinder must conform to LP Gas Code NFPA/ANSI 58.
- Install two “D” cell batteries (NOT included) in the battery box on the bottom of the appliance. Check the batteries are facing the correct direction



- Use shifting spanner to attach supplied gas regulator (with brass connector already) to the appliance. And connect to the bottom of the appliance marked “Gas inlet”. **Do not over tighten. Over tighten may causing a gas leak!** Ensure that you use supplied washers and “Teflon” tape on all connectors and check for any gas smell before ignition as instruction. Make sure the gas inlet connector and water inlet connector are screwed all the way on.

Tighten the fittings with use wrenches on both the brass adapter fitting on the appliance and the brass connector on the end of the hose



- Attach the water output apparatus (shower head) to the fitting marked “Water outlet”. **DO NOT OVER TIGHTEN!** Make sure to insert the supplied rubber gasket at the connections. Tighten by hand only.
- Only use the pressure regulator & hose supplied with this appliance.
- Place at a comfortable height without putting stress on the gas hose. If the unit is to be permanently mounted, use screws to attach the bottom tab firmly.
- Before opening LP cylinder valve, check the coupling nut for tightness. When appliance is not in use, turn off LP cylinder valve on supply cylinder.

- Never use LP cylinder if visibly rusted, damaged or out of date.
- Clean and inspect the hose before each use of the appliance. If there is evidence of abrasion, wear, cuts or leaks, the hose must be replaced prior to the appliance being put into operation.

Before going to the USE section:

Check around area for flammables, especially gasoline or other vapors which may ignite. The exhaust and top of the portable tankless water heater will get HOT! Make sure there are no foreign objects around the portable tankless water heater or have fallen into the top.

Use and Starting

 **WARNING:** This model is intended for recreational & portable use only. This model **CANNOT** be permanently mounted or plumbed in any way.

1. Turn on incoming water supply. Ensure that you have adequate water pressure of between 2.5–110 PSI (BW158) / 3.0-110 PSI (BW211) / 3.6 -110PSI (BW264)/3.8-110PSI (BW318)/4.0-110PSI(BW422).
2. Turn your water output device to its “off” position.
3. Turn the gas valve on the cylinder all the way open.
4. IF THE SMELL OF GAS IS DETECTED, TURN OFF THE GAS VALVE IMMEDIATELY!!
5. Set the water knob on the face of the portable tankless water heater to its highest setting.
6. Set the gasknob on the face of the portable tankless water heater to its minimum setting.
7. Turn on your water output device to the “on” position and adjust to the desired water flow.
8. There will be a series of audible clicks and the burner will ignite. Should the burner not ignite after 5 seconds, shut off and go to the “Troubleshooting” section.
9. Upon completion of use or storage, open the drain valve (ribbed cylindrical stem next to the water input valve) to ensure draining of water.
10. Turn off your gas supply.

 **11. WARNING:** If the outside temperature is around or below freezing (32 °F, 0°C), ensure that the drain plug is opened and water drained from the portable tankless water heater after each use to avoid internal damage to the heat exchanger. You will also need to unhook the outgoing water line to ensure that any water in the heat exchanger is drained. Failure to properly drain your portable tankless water heater will cause water damage which may or may not be reparable.



Before operate the drain plug, must be

1. Ensure that the water heater is disconnected from the gas supply.
2. Ensure that the water heater is disconnected from the water supply. (Turn off cold water inlet switch.)
3. Turn the shower switch to "ON".
4. Open the drain plug to drain off the residual water.

Adjustment

The temperature of the outgoing water is dependent on the temperature of the incoming water balanced with the amount of heat applied. Use extreme caution in setting the outlet water temperature.

1. With the water knob set to high, and the gas knob set to low, feel the outgoing water. This is the lowest setting available.
2. To initially raise the outgoing temperature, slowly turn the gas valve towards maximum. Adjust slowly and check the temperature often. There will be a slight delay between increasing the gas supply and the increase in water temperature.
3. Should the outlet water temperature need to be higher, slowly reduce the water flow knob until desired temperature is reached.

(Warning: Do not alter or change this water heater's original temperature sensor)

⚠️ WARNING: THE PORTABLE TANKLESS WATER HEATER IS CAPABLE OF PRODUCING SCALDING WATER TEMPERATURES!

Following Phenomena Are Not Real Troubles

Protective function	Reaction	Remarks
Water pressure too high	If water pressure is over 110PSI, the water-out valve will release water and lower the pressure	Increase the valve pressure limit according to local water supply pressure
Water pressure too low	If water pressure is below 2.5PSI (BW158)/3.0PSI(BW211)/3.6PSI(BW264) /3.8PSI(BW318)/4.0PSI(BW422) the water heater cannot be ignited	Use the water heater later when pressure becomes higher

Low battery	The power of battery will become less after use for some time, thus the water heater cannot be ignited.	Change battery
Over heat protection	Water heater shut off automatically when water temperature is 176°F ±41°F (75°C ±5°C)(BW158/BW211) 185°F ±41°F (85°C ±5°C)(BW264/BW318 /BW422)	Re-start water heater later when water becomes cooler

Avoid frozen broken

During the stage of no using, the temperature is same between the inside and outside of water, the water will expand when temperature reach 32°F (0°C) even broken the water pipe. This is normal phenomenon and not is the quality problem.

Open the drain plug to drain off the residual water in the water heater and then screw it tightly if the environment where the water heater is installed drops below 32°F (0°C). This can prevent the cold from damaging the water heater.

Troubleshooting

Portable tankless water heater will not start –there are no audible clicks at startup:

- a. The first thing to check is to ensure that the incoming water on the “right” side of the portable tankless water heater. If the incoming and outgoing are reversed, the portable tankless water heater will not work. The incoming is on the far right and the outgoing is in the middle.
- b. Check to make sure you have fresh batteries and they are installed in the correct position.
- c. Number one reason that the portable tankless water heater does not ignite is that there is not enough water pressure. You need a minimum of 2.5 PSI (BW158)/ 3.0 PSI (BW211) /3.6 PSI (BW264)/3.8 PSI (BW318) / 4.0PSI(BW422) sustained. Municipal water should supply enough water pressure.

ADJUSTMENT:

- d. It is possible that some debris or epoxy might have entered the water inlet pipe. Check to see if the filter screen on the water inlet is clear of debris. You can also reverse the hookup by taking your water source and hooking it up to the water outlet side and back flushing the system.
- e. Propane gas cylinders sometimes are contaminated with air, especially new cylinders upon their first filling. Cycle the portable tankless water heater turning off and on your output flow or similar.
Should a portable tankless water heater fail to light or stay lit after 10 cycles, [please contact us via email at junskycustomerservice@outlook.com](mailto:junskycustomerservice@outlook.com)

Portable tankless water heaters starts, then shuts off:

- a. The portable tankless water heater requires a minimum of about 0.40 gallons per minute (1.5 liters) and a minimum of about 2.5 PSI / 0.17 bar (BW158); 0.50 gallons minute (1.9 liters) and a minimum of about 3.0 PSI / 0.20 bar (BW211); 0.62 gallons minute (2.3 liters) and a minimum of about 3.6 PSI / 0.24 bar (BW264); 0.64 gallons minute (2.4 liters) and a minimum of about 3.8 PSI / 0.26 bar (BW318); 0.77 gallons minute (2.9 liters) and a minimum of about 4.0 PSI / 0.28 bar (BS422).

Note: water pressure is at the lower end of operating parameters. You will need a sustained water pressure of approximately 35-65 PSI / 2.4-4.5 bar for adequate use if you are using a 12/18/120 volt pump.

- b. Out of, or low on gas. Propane gas cylinders sometimes are contaminated with air, especially new tanks upon their first filling. Cycle the portable tankless water heater on and off by using the shower head switch several times to purge the air from the gas. If this doesn't clear the air then the tank must be purged.
- c. One of the ignition sensors is bent and/or too close to the burner. Look to ensure that the ignition pins and the heat sensor are completely vertical and they do a 90 degree to the back of the box. If they are not straight (i.e. a 45 degree angle) then you can straighten them with pliers.
- d. The thermocouple is either too high or too low to complete the circuit. Check to ensure that the thermocouple is flush with the hole in the heat exchanger.
- e. The gas sensor wire (looks like a black ground wire on the gas regulator) flange might have come loose or is no longer connected.
- f. There is a faulty heat sensor. This is usually diagnosed by taking the front case off of the portable tankless water heater and let it run. If it continues to operate, then one of the sensors and/or the wire harness needs to be replaced. This may also be caused by insufficient clearance on the back of the portable tankless water heater where the majority of air intake is.
- g. The valve on the propane tank should be all the way "Open".
- h. Fresh batteries are required for ignition spark. Make sure batteries are aligned in the proper polarity (+/-).

The water does not get hot enough:

- a. You are operating the portable tankless water heater above 6,000 feet / 2,000 meters. We only recommend using it below elevations of 6,000 feet.
- b. Look into the viewer panes (middle horizontal windows on the front cover) to see if there is a blue flame. If the flame is yellow there could be a cracked gas regulator. Do Not Attempt to use the portable tankless water heater.

Water is flowing, but there is no hot water coming out:

- a. Ensure that you have the incoming water supply and the outgoing water supply hooked up properly. Your water supply should be attached to your incoming

connection (located on the far right) and the shower head should be attached to the outgoing water (located as the middle connection).

- b. Ensure that you have adequate water pressure of at least 2.5PSI / 0.17 bar, (BW158);3.0 PSI / 0.20 bar (BW211); 3.6 PSI /0.24 bar (BW264);3.8 PSI/0.26 bar (BW318);4.0PSI/0.28bar(BW422)sustained.
- c. Ensure that you have adequate gas in your propane bottle and that the LP regulator is threaded all of the way on to the portable tankless water heater.
- d. Fresh batteries are required for ignition spark. Make sure batteries are aligned in the proper polarity (+/-).

The portable tankless water heater does nothing:

- a. Ensure that you have your water source hooked up to the water inlet side (far right connection) and the shower handle is hooked up on the water outlet side (middle connection).
- b. Ensure that you have an adequate supply of propane.
- c. Ensure that you have fresh batteries.

LIMITED WARRANTY

The manufacturer warrants heater components (except paint and finish) to be free from defect in materials and workmanship for 1 year from the date of purchase. All accessories (included with shower or purchased separately) are warranted from defect in materials and workmanship for 90 days from the original purchasing date. Within these periods, the manufacturer will replace the defective parts.

Product paint and finish are not warranted. The exterior finish of the product will wear down over time.

Degrees Celsius and Fahrenheit conversion table

Celsius (°C)	Fahrenheit (°F)	Celsius (°C)	Fahrenheit (°F)
1	33.8	49	120.2
2	35.6	50	122
3	37.4	51	123.8
4	39.2	52	125.6
5	41	53	127.4
6	42.8	54	129.2
7	44.6	55	131
8	46.4	56	132.8
9	48.2	57	134.6
10	50	58	136.4
11	51.8	59	138.2
12	53.6	60	140
13	55.4	61	141.8
14	57.2	62	143.6
15	59	63	145.4
16	60.8	64	147.2
17	62.6	65	149
18	64.4	66	150.8
19	66.2	67	152.6
20	68	68	154.4
21	69.8	69	156.2
22	71.6	70	158
23	73.4	71	159.8
24	75.2	72	161.6
25	77	73	163.4
26	78.8	74	165.2
27	80.6	75	167
28	82.4	76	168.8
29	84.2	77	170.6
30	86	78	172.4
31	87.8	79	174.2
32	89.6	80	176
33	91.4	81	177.8
34	93.2	82	179.6
35	95	83	181.4
36	96.8	84	183.2
37	98.6	85	185
38	100.4	86	186.8
39	102.2	87	188.6
40	104	88	190.4
41	105.8	89	192.2
42	107.6	90	194
43	109.4	91	195.8
44	111.2	92	197.6
45	113	93	199.4
46	114.8	94	201.2
47	116.6	95	203
48	118.4	96	204.8



Company : Junsky America Inc,

Hot line: 857 222 5033

Email: junskyamerica@outlook.com

junskycustomerservice@outlook.com

Address: 150 William F McClellan Highway,
Boston, MA 02128