

UNITED STATES STOVE CO.

EST^d 1869

Models: CCS14 / CCS18 CAMP STOVE ONLY

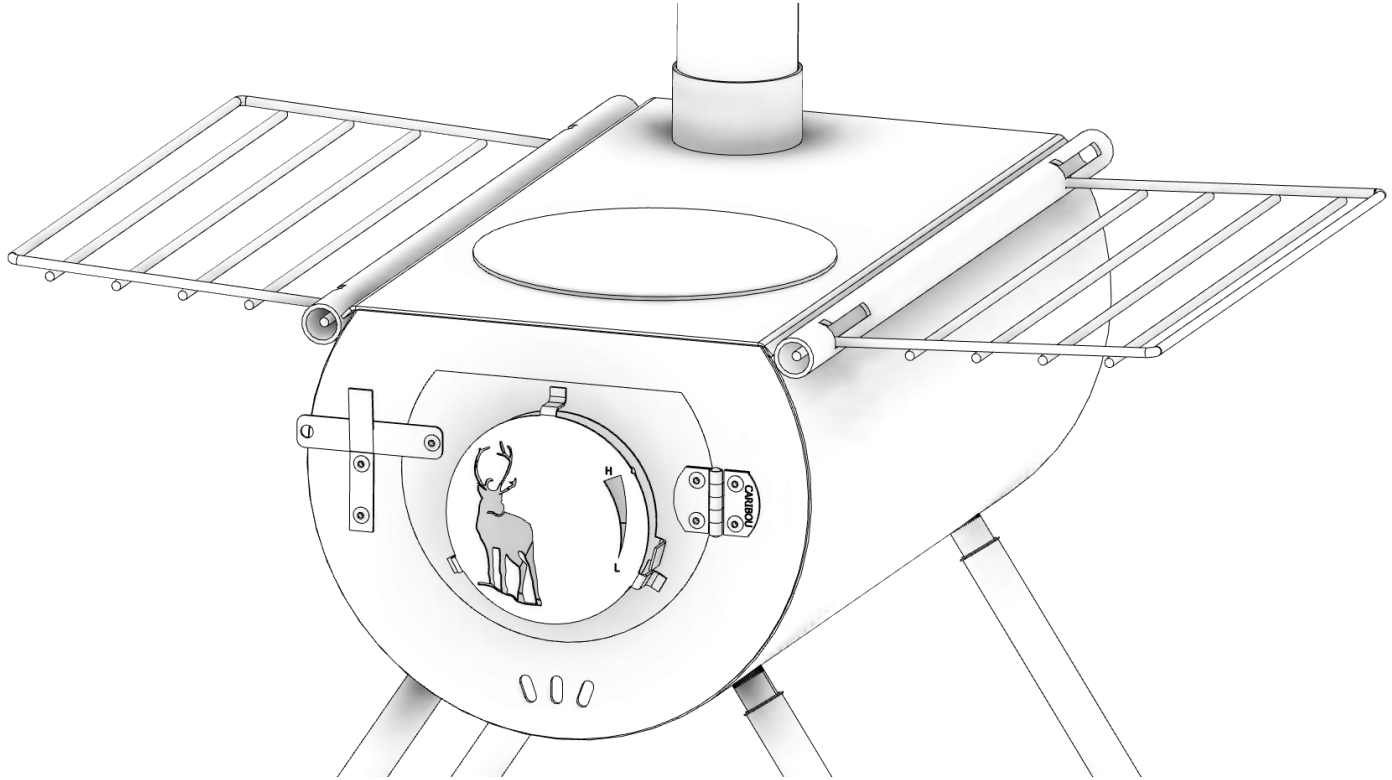

! CALIFORNIA PROPOSITION 65 WARNING:

This product can expose you to chemicals including carbon monoxide, which is known to the State of California to cause cancer, birth defects and/or other reproductive harm. For more information, go to www.P65warnings.ca.gov

WARNING: Failure to follow the instructions in this manual could result in damage, injury, or death. Read all instructions before using this stove.

THIS WOOD HEATER NEEDS PERIODIC INSPECTION AND REPAIR FOR PROPER OPERATION. CONSULT THE OWNER'S MANUAL FOR FURTHER INFORMATION. IT IS AGAINST FEDERAL REGULATIONS TO OPERATE THIS WOOD HEATER IN A MANNER INCONSISTENT WITH THE OPERATING INSTRUCTIONS IN THE OWNER'S MANUAL.

CAUTION:

Please read this entire manual before installation and use of this wood fuel burning appliance. Keep children, furniture, fixtures and all combustibles away from any heating appliance.

CAUTION:

- Keep children away.
- Supervise children in the same vicinity as this appliance.
- Alert children and adults to the hazards of high temperatures.
- Do NOT operate with protective barriers open or removed.
- Hot while in operation! Keep clothing, furniture and other combustibles away. Contact may cause skin burns!
- Do NOT over fire your unit.
- NEVER allow your stove to get so hot that your stovepipe becomes red. Reduce airflow on your door air intake to reduce the heat.
- Installation MUST comply with local, regional, state and national codes and regulations.
- Consult local building, fire officials or authorities having jurisdiction.

United States Stove Company
227 Industrial Park Road
South Pittsburg, TN 37380

U.S. ENVIRONMENTAL PROTECTION AGENCY
This unit is not a certified residential wood heater.
For portable and temporary use only.

853157B-1005i

WARNING:

- Keep all flame and heat sources away from tent fabric. Many tents are flame resistant; this does not mean they are fire proof. Do not insert the stove pipe directly through the fabric. A stove jack made specifically for tents must be used.
- If a rain fly is being used on the tent a rubber military style stove jack must be used in both the rain fly and the tent.
- Only for use in tents made for stove usage (i.e. a canvas wall tent with a stove jack); not for use in nylon or other tents not suited for stove use.
- Always leave a window cracked or door partly open when using this stove.
- NEVER place your stove on a tent floor or other flammable material.
- Stove sparks will burn holes in a fire treated roof. A spark arrestor will help prevent most sparks from reaching your roof.

WARNING:

Tent wood stoves are designed for use in tents and outside only. Do not use stove in a cabin, home, workshop, etc. Insure you have fireproof material underneath the stove and have proper heat standoff distance from walls.

WARNING:

NEVER USE FLAMMABLE LIQUIDS TO START A FIRE IN YOUR STOVE.

WARNING:

NEVER put your stove on a tent floor or other flammable material.

DANGER:

Always leave a window cracked or door partly opened when using this stove. A minimum opening of 20 square inches is required for adequate ventilation.

WARNING:

Stove sparks will burn holes in a fire treated roof. A spark arrestor will prevent most sparks from reaching your roof. The use of a rain fly with properly fitted stove jack will also help prevent damage to your tent.

WARNING:

Never allow your stove to get so hot that your stove or stovepipe becomes red. A red hot stove will cause the metal to warp. Reduce airflow on your door air intake to reduce the stove temperature.

OPTIONAL KIT

The CCSPK kit contains six (6) chimney pipes. This stove can be used without the additional chimney pipes; however, for use of this appliance in a tent the CCSPK kit is required.

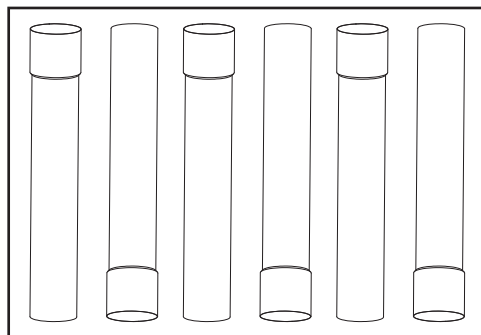

ASSEMBLY

Always ensure your stove is on a level surface to avoid any possible problems. Have a nonflammable area in front of your stove in case sparks or wood falls out of your stove when you open the door.

1. Remove all components from the inside of the fire box.
2. Turn the stove upside down and install the legs. Tighten the threaded knob on each leg to hold in place.
3. Stand the stove upright on its legs. The legs may be adjusted to level the stove or compensate for uneven ground.
4. Attach the two wire shelves to the sides of the fire box by inserting the ends of the shelf into the tubes on either side of the stove.

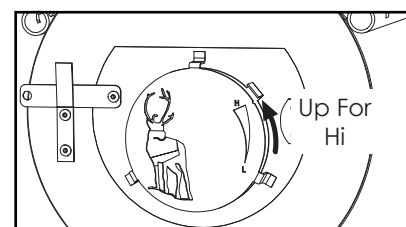
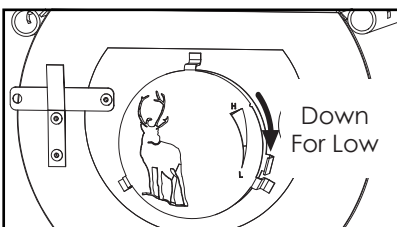
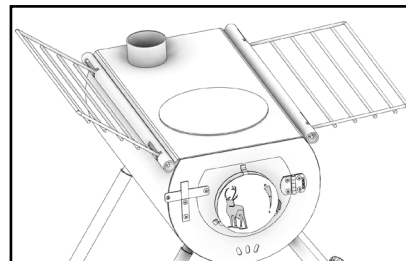
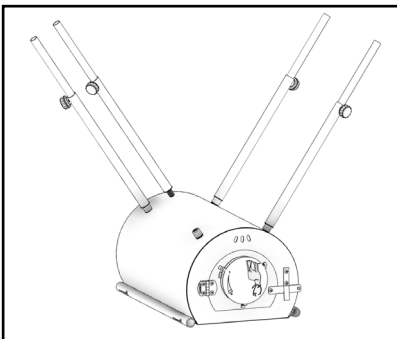
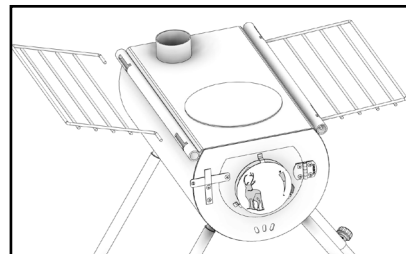
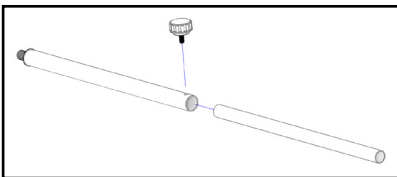

- Installing the chimney pipe - Install the spark arrestor over the top of one of the pipes. Secure the spark arrestor to the pipe by tightening down the #10AB X 1/2 screw. Then install this pipe into the wide end of the next and so on until all six pipes are assembled together. If using the stove in windy conditions pipe clamps should be used to secure the pipes together (pipe clamps not included). Once the chimney is assembled lift the chimney up through the stove jack in the tent and then install into the top of the stove. Note: Depending on stove jack size some chimney sections may need to be installed down through the stove jack from the outside of the tent.

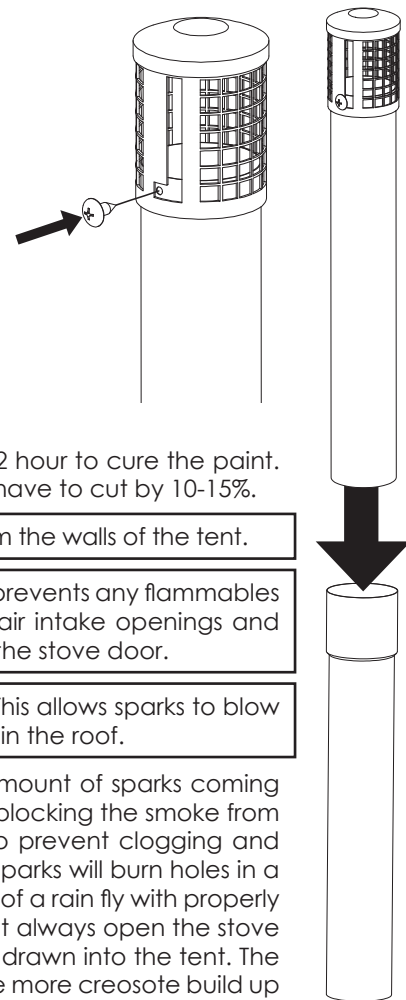

WARNING: Before using the stove the first time the paint must be properly cured.

CURING THE PAINT

Set your new stove up in your backyard or driveway and burn wood in the stove for 1-2 hour to cure the paint. The damper makes your stove 10-15% more efficient reducing the amount of wood you have to cut by 10-15%.

WARNING: Keep the firebox portion of the stove a minimum of 36" (914 mm) away from the walls of the tent.

WARNING: Keep all combustible materials a minimum of 3 feet away from the stove. This prevents any flammables from catching fire due to the stove heat, prevents sparks from popping through the air intake openings and catching flammables on fire and also in case sparks pop out when you open the stove door.

WARNING: The stove pipe should extend a minimum of 6" above the ridge of the tent. This allows sparks to blow away from the tent roof reducing the possibility of spark holes being burnt in the roof.

Always use the included spark arrestor. When properly used this device reduces the amount of sparks coming out of the stove pipe. Check spark arrestor daily to insure there is no buildup of creosote blocking the smoke from going through the spark arrestor. The spark arrestor must be cleaned every 2-3 days to prevent clogging and reduce the risk of a chimney fire. Stove sparks will burn holes in a fire treated roof. Stove sparks will burn holes in a fire treated roof. A spark arrestor will prevent most sparks from reaching your roof. The use of a rain fly with properly fitted stove jack will also help prevent damage to your tent. To reduce smoke in your tent always open the stove door slowly with the damper wide open. If you open the stove door quickly the smoke is drawn into the tent. The more you damper the stove pipe down or/and reduce the air intake on the stove door the more creosote build up you will have in the stove pipe and spark arrestor. If you get too much creosote in the stove pipe you can possibly have a fire in your stove pipe. When breaking camp, remove the creosote in your stove pipe by gently banging the stove pipes together to loosen the creosote. It is normal to periodically clean the spark arrestor every 2-3 days. To reduce smoke in your tent always open the stove door slowly with the damper wide open. If you open the stove door quickly the smoke is drawn into the tent.

WOOD FOR STOVES

Dry hardwoods burn the most efficiently and provide the most heat. If you use soft woods you will have to cut much more firewood and you will have more creosote buildup.

CAMPING IN WINDY CONDITIONS

If using the stove in windy conditions, secure all sections of stove pipe at the joints and where the pipe attaches to the stove with pipe clamps (not included). Windy conditions will cause the stove pipe to loosen when the tent roof billows in the wind. Also stake down the front and back of your tent with the grommet on each end of your ridge to reduce movement of the tent.

CLEARANCES

The stove must be placed on a non-combustible surface. The following minimum requirements must apply:

Floor Protection Clearances				
USA	Front	Sides	Rear	Thickness
	16"	6"	6"	1/64"
CANADA	18" (460 mm)	8" (200 mm)	8" (200 mm)	Steel Plate 1/64" (0.38 mm)

Clearances to Combustible Materials			
Back Wall	Side Wall	Corners	Height*
36" (914 mm)	36" (914 mm)	36" (914 mm)	60" (1524 mm)
*Height, from top of the stove to the ceiling			

Verify the clearance between your pipe and the surrounding combustibles.

CAUTION:

The more you use the door draft to reduce air flow and/or use soft or moist wood, the more creosote buildup you will experience in the stove pipe and spark arrestor. Be sure to check your stove pipe and the spark arrestor regularly for creosote, and clean as necessary. DRY hardwoods burn the most efficiently and provide the most heat.

NEVER use gasoline, gasoline-type lantern fuel, kerosene, charcoal lighter fluid or similar liquids to start or "freshen up" a fire in this heater. Keep all such liquids well away from the heater while in use. Additionally, never apply fire-starter to hot embers in the stove. Do not use chemicals or fluids to start the fire. Do not burn flammable fluids such as gasoline, NAPHTHA or engine oil.

Adhere to all clearances to combustible material, as well as floor protection requirements, mentioned in this manual. Do NOT store fuel closer than specified clearances to combustibles or within the space needed for loading the stove and ash removal. This unit was designed for operation only with the loading door closed and tightly latched. Operating this unit with the loading door latched loosely or open will allow excessive combustion air to reach the fire and will result in dangerously high temperatures. High unit temperatures can damage the unit, void the warranty or ignite creosote deposited in the flue system by previous, slow burning fires.

STARTING YOUR FIRE

- Be sure the air intake control on the door is fully open.
- Place several sheets of crumpled paper in the center of the firebox, then place approximately 8 to 10 small pieces of dry kindling over the top of the paper, forming a "tee-pee" shape. If you place any heating wood in the firebox at this time, choose very small pieces. You may also choose solid "fire-starters" to help start your fire. Remember, NO flammable liquids such as lighter fluid or gas may be used!
- To avoid back draft from cold air outside the structure, you should warm the chimney prior to igniting the wood in the firebox. Twist a few sheets of paper into a torch shape, then light it and hold it as close as possible to the entry of the flue, inside the combustion chamber, to warm the chimney. USE CAUTION so that you do not burn yourself. Once an updraft into the flue is initiated, you may light your stove by lighting the paper and kindling tee-pee that is inside the firebox.
- Leave the stove door slightly opened for 5-10 minutes, or until good combustion is achieved.
- DO NOT leave the fire while the door is opened. At this time you may close the door and progressively adjust the air control to achieve the preferred intensity of the fire.
- Once you have a bed of embers, reload the unit with larger wood. For safety and best performance, you should keep your wood load no higher than 6 inches.
- Use the circular draft control on the stove door to regulate the intake air for your fire. We recommend installing a magnetic thermometer on your stove pipe, approximately 18" (46 cm) above the stove's surface. The ideal temperature of the flue pipe is between 250° F and 500° F (121° C - 260° C). Below this range can encourage creosote buildup, and above this range can waste heat and potentially lead to over-firing.

CAUTION:

Remember that wood combustion consumes ambient oxygen; as mentioned previously, be sure to always have some sort of an outside air intake such as a cracked door or opened window.

CAUTION:

Be sure to check the spark arrestor daily and clean as necessary, as a clogged spark arrestor can cause smoke to spill out of the stove door or could even cause a fire in the stove pipe.

ASH REMOVAL

Inspect the firebox daily for ash accumulation. Ashes should be placed in a metal container with a tight fitting lid. The closed container of ashes should be placed on a noncombustible floor or the ground, well away from all combustible materials, pending final disposal. If the ashes are disposed of by burial in soil or otherwise locally dispersed, they should be retained in the closed container until all cinders have been thoroughly cooled. Remember to store the stove with ashes cleaned from the firebox, or premature rust and degradation of the firebox will occur. A small open container of a desiccant (i.e. cat litter) in the stove can help prevent corrosion when the stove is not being used; be certain to remove it before transporting the stove or building a fire. Never store your stove with ash in the firebox. The ash will draw moisture and your stove will rust.

Inspect the flue system to be sure it is properly intact. Inspect the pipe and spark arrestor, rain cap, etc. for creosote buildup, and clean if necessary. Visually inspect any other parts (including accessories, options, etc.) for proper function.

Limited Warranty

The operation of this unit in a manner inconsistent with the owner's manual will void the warranty and is also against federal regulations. United States Stove Company warrants this product to be free from defects in material and workmanship, to the original retail purchaser only, for the time period identified below, measured from the date of the initial purchase as evidenced on an invoice, canceled check, sales receipt, etc., to receipt of a claim by United States Stove Company ("USSC") or an authorized dealer, as follows:

TIME PERIOD

Firebox / Heat Exchanger..... One Year

WARRANTY CONDITIONS

- This warranty only covers USSC appliances that are purchased through an USSC authorized retailer, dealer or distributor.
- This warranty is only valid while the USSC appliance remains at the site of original installation. This warranty does not apply to products purchased for rental use.

CLAIM PROCEDURE

Contact United States Stove Company for warranty service. You will be asked to provide detailed descriptions and pertinent data, including proof of purchase which will be returned upon request. Providing the unit has been installed and used in accordance with the Owners Manual supplied with the unit and the issue does not fall under a situation of exclusion, United States Stove Company will either:

- Replace the defective part free of charge. Parts and/or service replacements made under the terms of this warranty are warranted only for the remaining period of the original unit warranty.
- Replace the unit free of charge. Should the unit be replaced by United States Stove Company "free of charge", all further warranty obligations are thereby met.
- Where the defect is of a cosmetic (non-functional) nature, United States Stove Company will bear reasonable expense to repair the unit, including such items as welding, painting, and incidental labor. A "reasonable expense" is defined by terms of this warranty as \$30.00/hour with full refund for any purchase of parts.

WARRANTY EXCLUSIONS

This warranty does not cover the following:

- Damage to or changes in surface finishes as a result of normal use. As a heating appliance, some changes in color or interior and exterior surface finishes may occur. This is not a flaw and is not covered under warranty.
- Damage to printed, plated, or enameled surfaces caused by fingerprints, accidents, misuse, scratches, melted items, or other external sources and residues left on the plated surfaces from the use of abrasive cleaners or polishes.
- Repair or replacement of parts that are subject to normal wear and tear during the warranty period. These parts include: paint and brick.
- Minor expansion, contraction, or movement of certain parts causing noise. These conditions are normal and complaints related to this noise are not covered by this warranty.
- Damages resulting from: (1) failure to install, operate, or maintain the appliance in accordance with the installation instructions, operating instructions, and listing agent identification label furnished with the appliance; (2) failure to install the appliance in accordance with local building codes and/or authorities having jurisdiction; (3) shipping or improper handling; (4) improper operation, abuse, misuse, continued operation with damaged, corroded or failed components, accident, alteration, or improperly/incorrectly performed repairs; (5) environmental conditions, weather, inadequate ventilation. (6) use of fuels other than those specified in the operating instructions; (7) installation or use of components not supplied with appliance or any other components not expressly authorized and approved by USSC; (8) modification of the appliance not expressly authorized and approved by USSC in writing.
- Non-USSC venting components, hearth components or other accessories used in conjunction with the appliance.
- USSC's obligation under this warranty does not extend to the appliance's capability to heat the desired space. Information is provided to assist the consumer and the dealer in selecting the proper appliance for the application. Consideration must be given to appliance location and configuration, environmental conditions, insulation and air tightness of the structure.

- Problems relating to smoking or creosote. Smoking is attributable to inadequate draft due to the design or installation of the flue system or installation of the unit itself. Creosote formation is largely attributable to improper operation of the unit and/or draft as mentioned above.
- Any cost associated with product removal and re-installation, travel, transportation, or shipping.
- Service calls to diagnose trouble (unless authorized in writing by the manufacturer).

THIS WARRANTY IS VOID IF

- The appliance has been over-fired or operated in atmospheres contaminated by chlorine, fluorine, or other damaging chemicals. Over-firing can be identified by, but not limited to, warped plates or tubes, rust colored cast iron, bubbling, cracking and discoloration of steel or enamel finishes.
- The appliance is subjected to prolonged periods of dampness or condensation.
- There is any damage to the appliance or other components due to water or weather damage which is the result of, but not limited to, improper chimney or venting installation.

LIMITATIONS OF LIABILITY

The owner's exclusive remedy and USSC's sole obligation under this warranty, under any other warranty, express or implied, or in contract, tort or otherwise, shall be limited to replacement, repair, or refund, in USSC's sole and absolute discretion. In no event will USSC be liable for any incidental or consequential damages. THE LIMITED WARRANTY SET FORTH HEREIN IS THE SOLE WARRANTY PROVIDED TO PURCHASER AND IS IN LIEU OF ALL OTHER WARRANTIES AND REPRESENTATIONS, EXPRESS OR IMPLIED. USSC MAKES NO REPRESENTATIONS OR WARRANTIES WHATSOEVER, EXPRESS OR IMPLIED, WITH RESPECT TO THE PRODUCT, OTHER THAN (i) THE LIMITED WARRANTY ABOVE, AND (ii) ANY IMPLIED WARRANTIES IMPOSED BY APPLICABLE LAW WHICH CANNOT BE WAIVED OR DISCLAIMED UNDER APPLICABLE LAW. ALL OTHER WARRANTIES OF ANY KIND, INCLUDING WITHOUT LIMITATION IMPLIED WARRANTIES OF MERCHANTABILITY AND FITNESS FOR A PARTICULAR PURPOSE, ARE HEREBY DISCLAIMED AND EXCLUDED TO THE FULLEST EXTENT NOT PROHIBITED BY APPLICABLE LAW. This Limited Warranty gives the purchaser specific legal rights; a purchaser may have other rights depending upon where he or she resides. Some states do not allow the exclusion or limitation of special, incidental or consequential damages, or state law may affect the duration of limitations, so the above exclusion and limitations may not be applicable.

WARRANTOR

The warrantor of record is United States Stove Company, PO Box 151, 227 Industrial Park Road, South Pittsburg, Tennessee 37380. Phone number: (800)-750-2723. Register your product on line at www.usstove.com. Save your proof of purchase, as documented in a receipt or invoice, with your records for any claims.

IMPORTANT

We congratulate you on your selection of United States Stove Company and its products. As the oldest solid fuel manufacturer in the United States (since 1869), the United States Stove Company is very proud of its products, service, employees, and satisfied customers. We would like to hear from you if you are not satisfied with the manner in which you have been handled by our distributor, dealer, representative, customer service department, parts department, or sales department. Please reach out to us by using any of the contact information listed above.